

ТИПОВЫЕ КОНСТРУКЦИИ, ИЗДЕЛИЯ И УЗЛЫ ЗДАНИЙ И СООРУЖЕНИЙ

СЕРИЯ 1.020.1-4

КОНСТРУКЦИИ РАМНОГО КАРКАСА МЕЖЖИДОВОГО ПРИМЕНЕНИЯ  
ДЛЯ МНОГОЭТАЖНЫХ ОБЩЕСТВЕННЫХ ЗДАНИЙ, ПРОИЗВОДСТВЕННЫХ  
И ВСПОМОГАТЕЛЬНЫХ ЗДАНИЙ ПРОМЫШЛЕННЫХ ПРЕДПРИЯТИЙ

выпуск 0-9

УКАЗАНИЯ ПО ПОДБОРУ ЭЛЕМЕНТОВ КАРКАСА  
(Вариант армирования изделий сталью классов Ат-IVС и Врп-I).

часть 2

СТР 112-239

Книга 2

СТР.(176-239)

ОКОНЧАНИЕ

24166-02

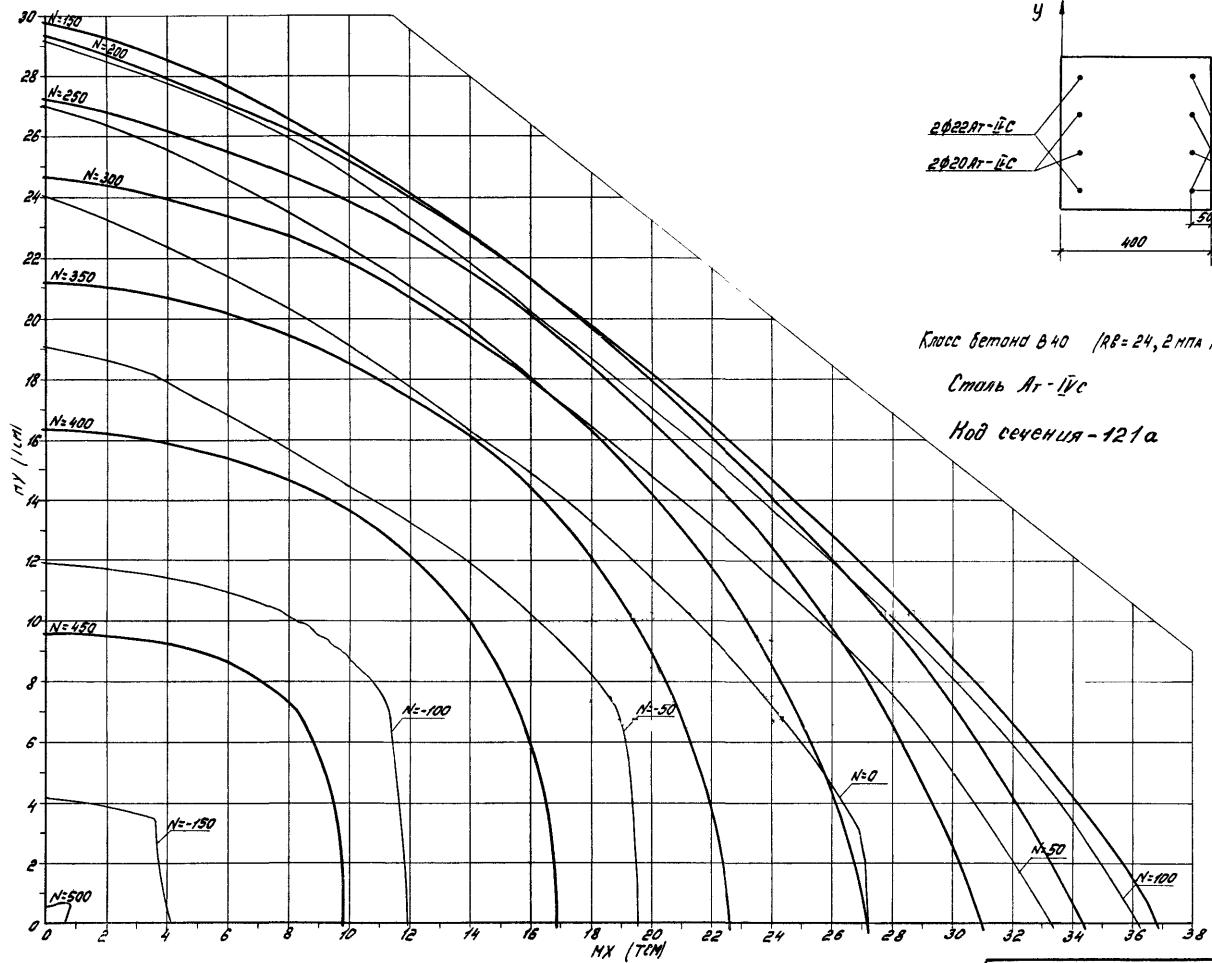

Класс бетона В40 ( $R_b = 24,2 \text{ МПа}$  при учёте  $\gamma_{b2} = 1,10$ )  
 Сталь Аг-IVс  
 Код сечения - 121а

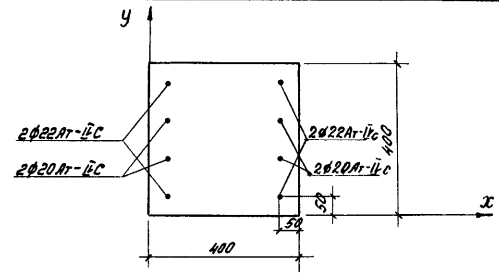

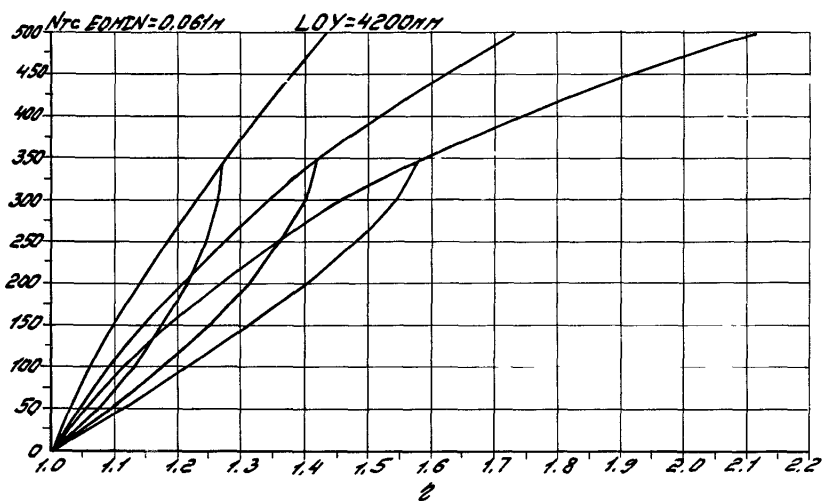
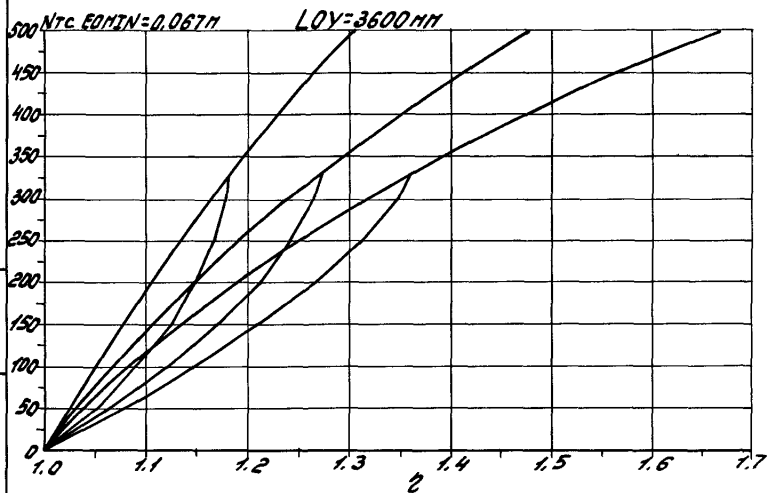
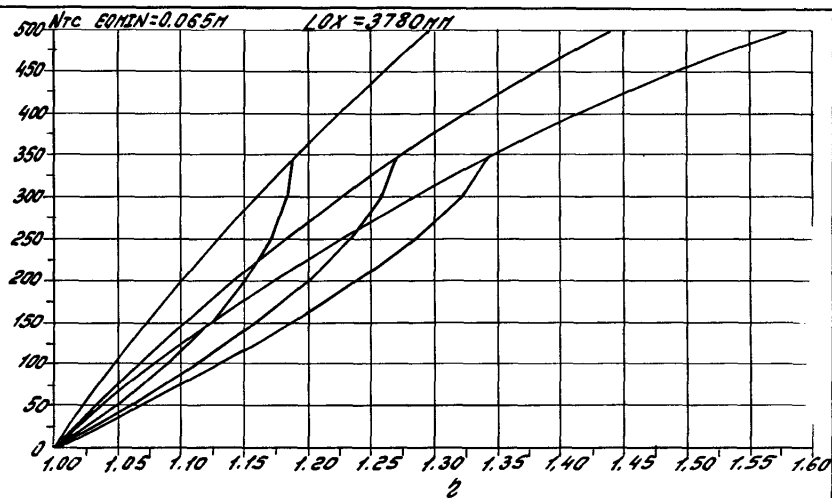
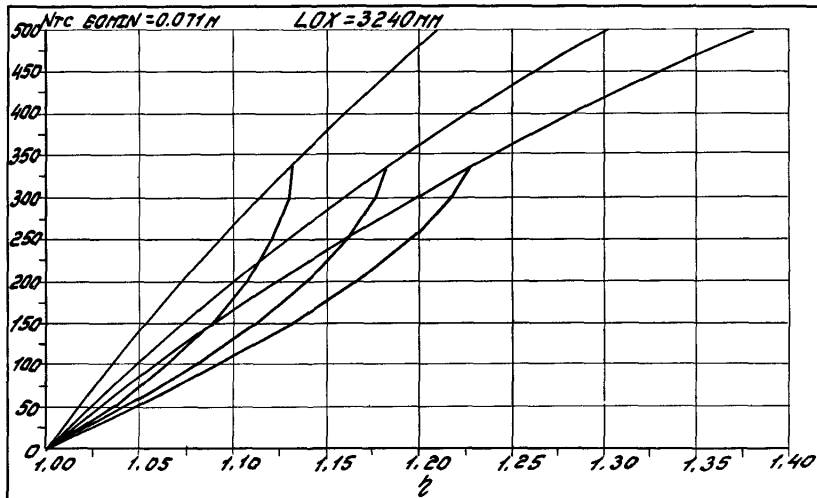

Шиф. А. 1000. Подпись и дата. В. сан. инд.

1.020.1-4 0-9 002      Шиф. 162

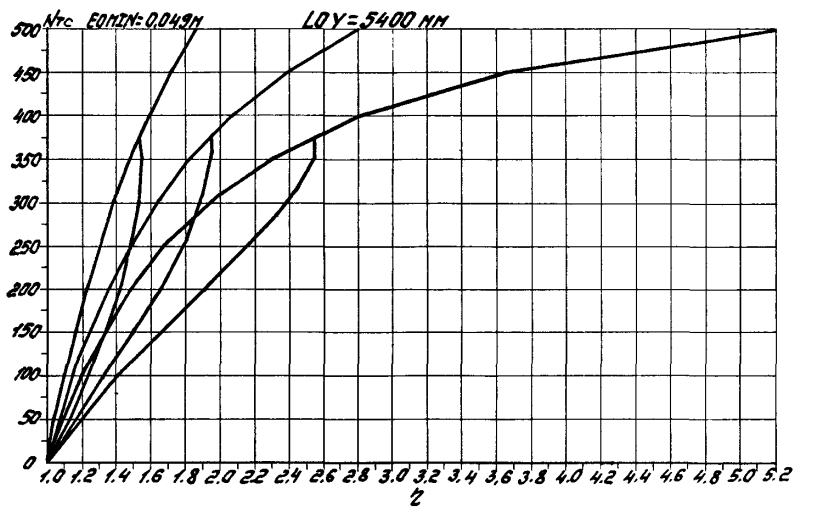
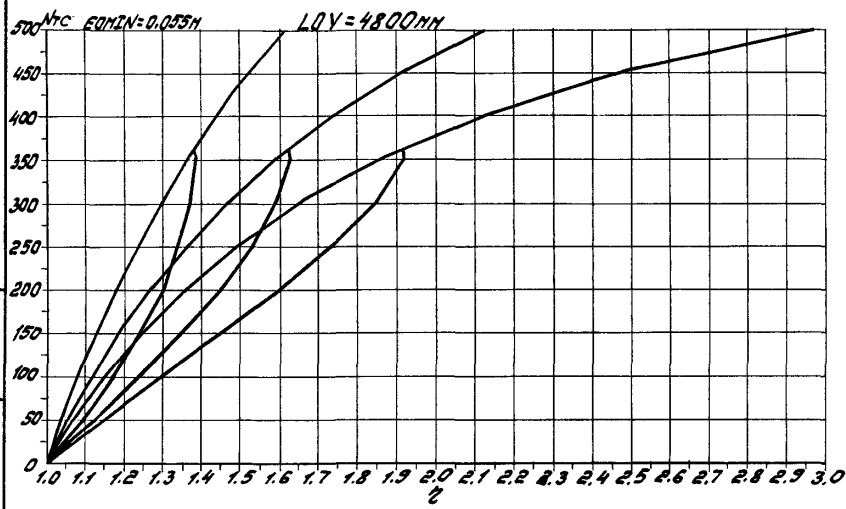
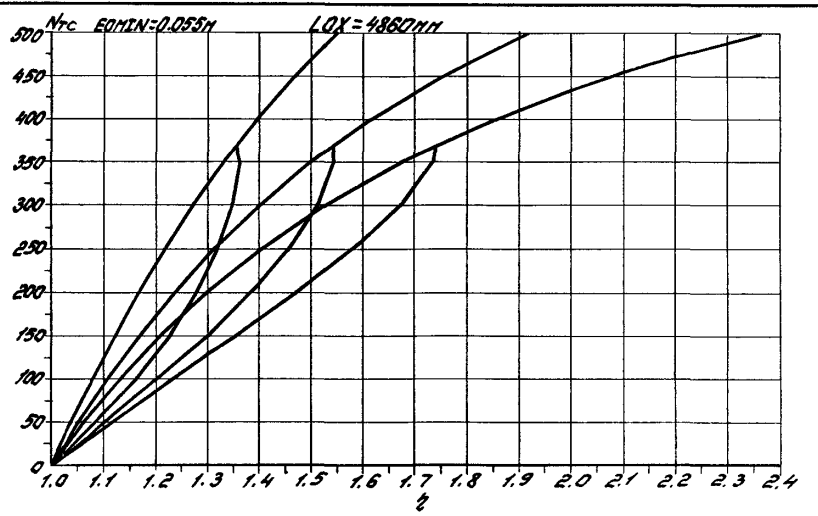
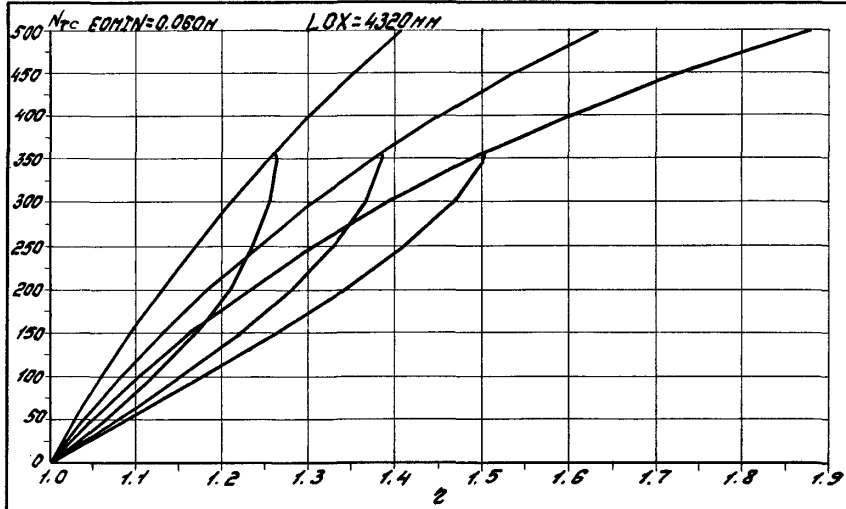

V. P. Khachat. In: Forces of thermal action. vol. 67

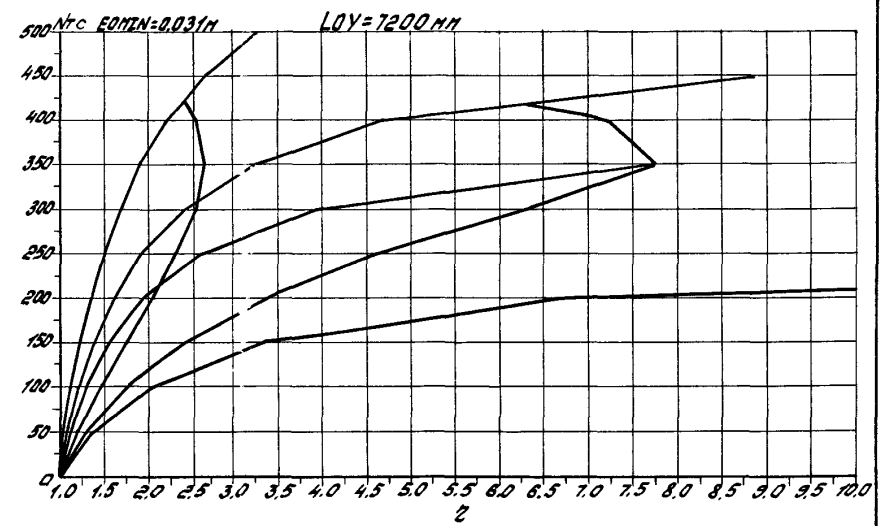
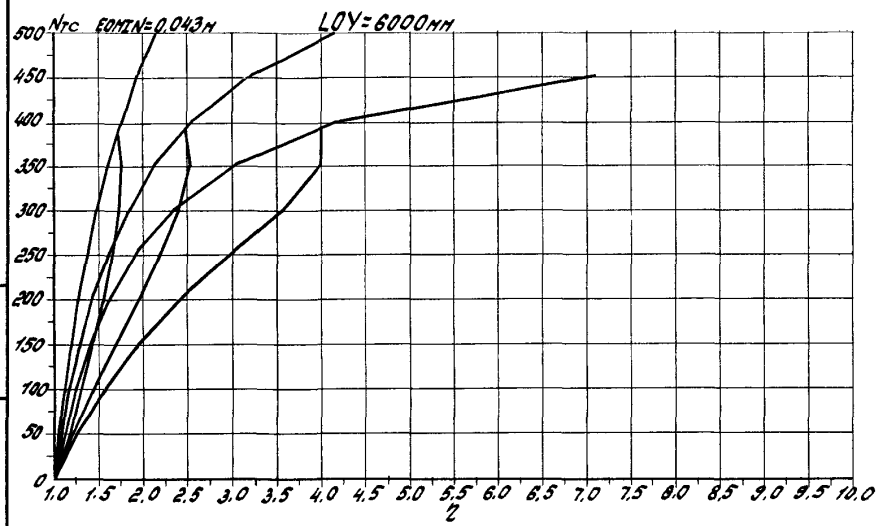
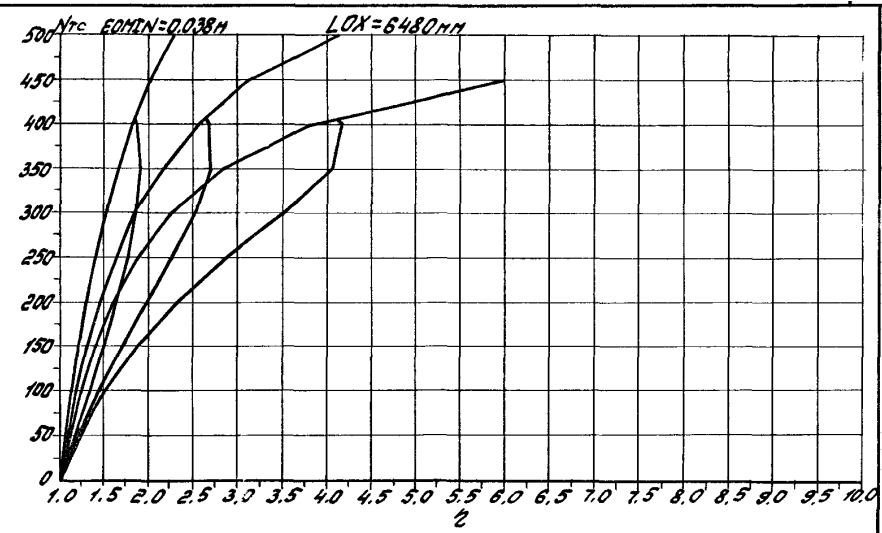
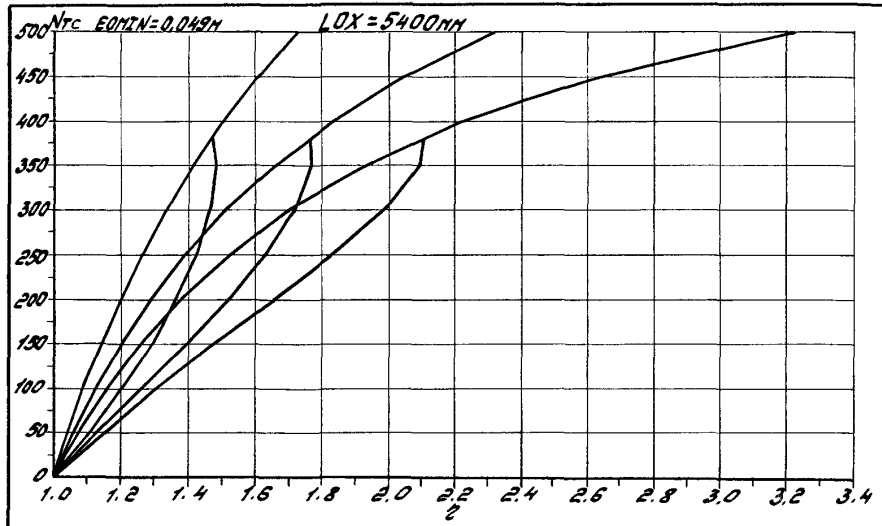

Угол наклона и длина стержня

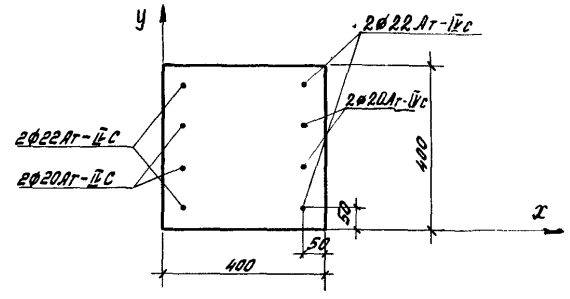
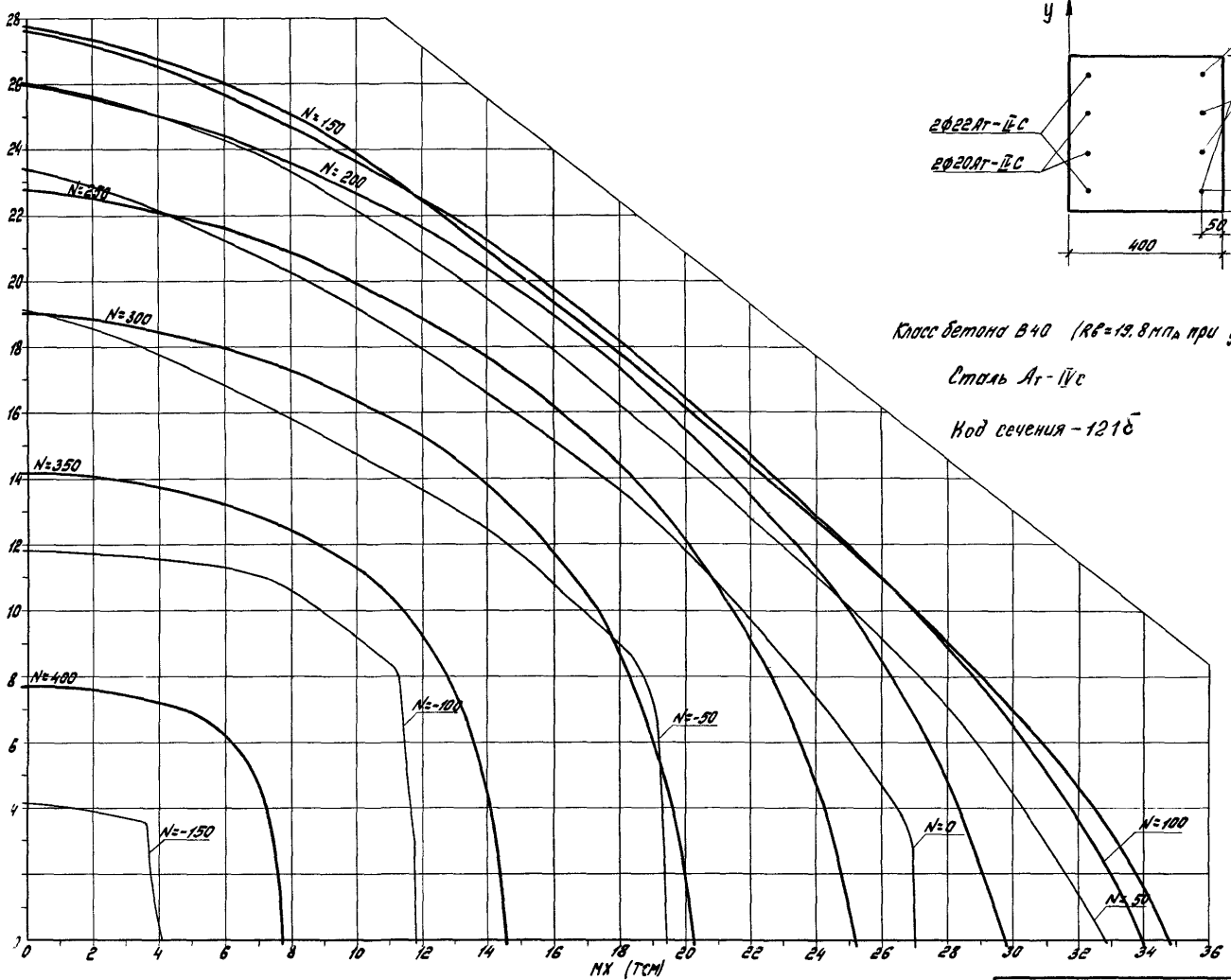

Класс бетона В40 ( $R_b = 19.8 \text{ МПа}$  при учете  $\gamma_{b2} = 0.90$ )  
 Сталь Ar-IVc  
 Код сечения - 1216

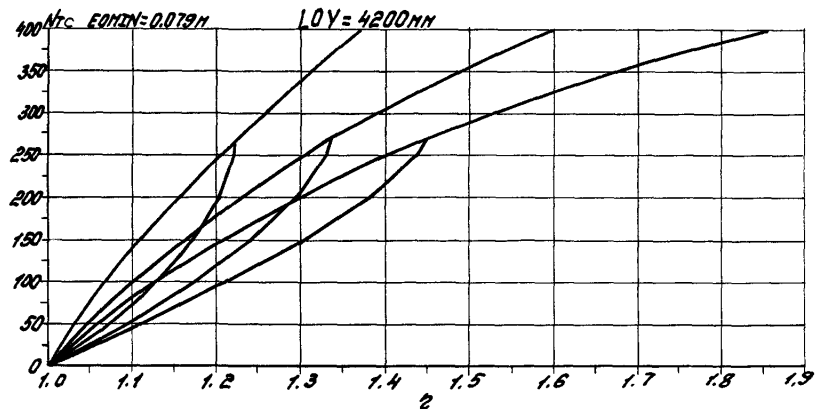
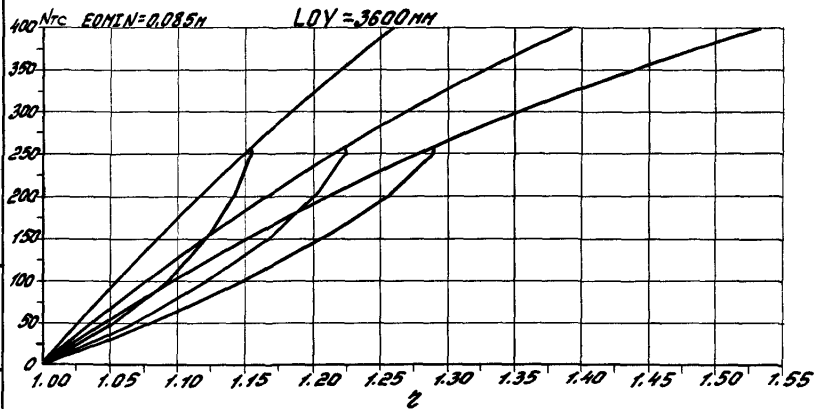
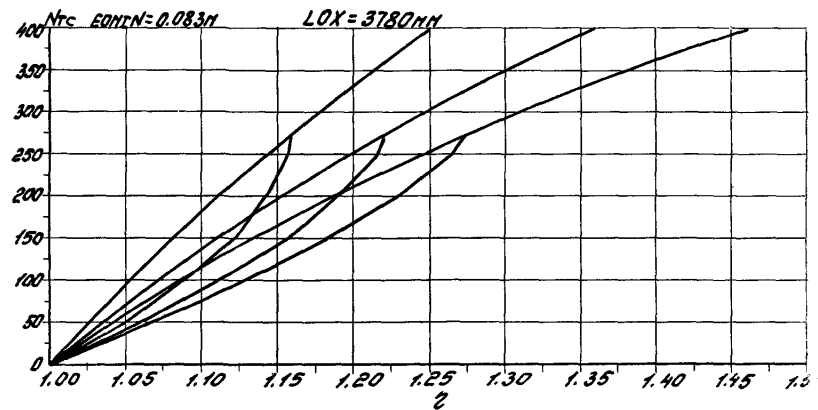
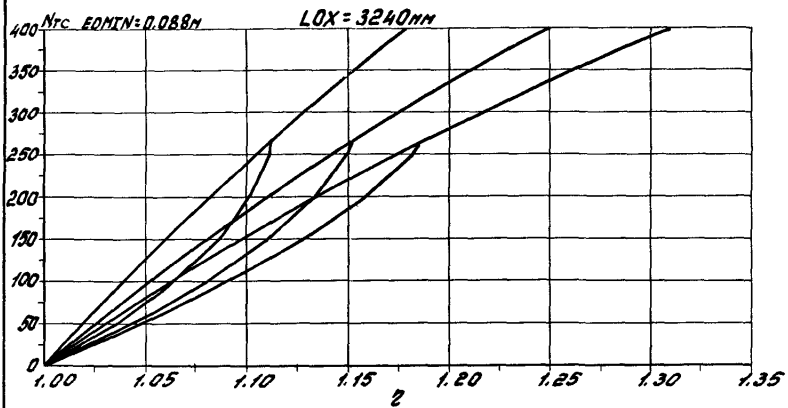

Шк. № 12-1242. Подпись и дата вкл. в архив

1.020.1-4 0-9 002

166

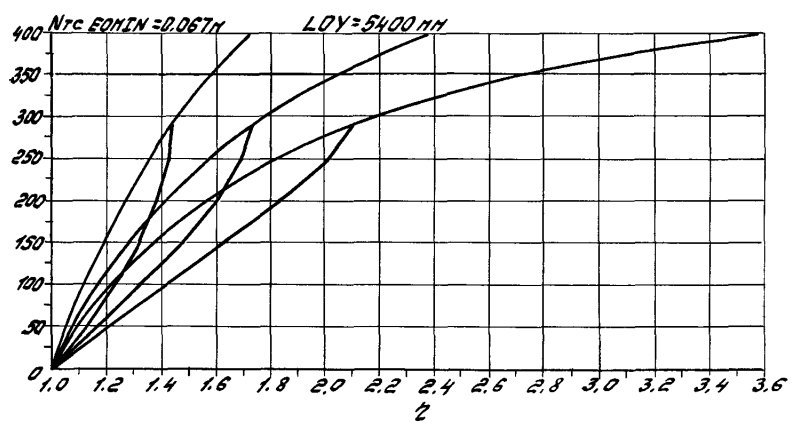
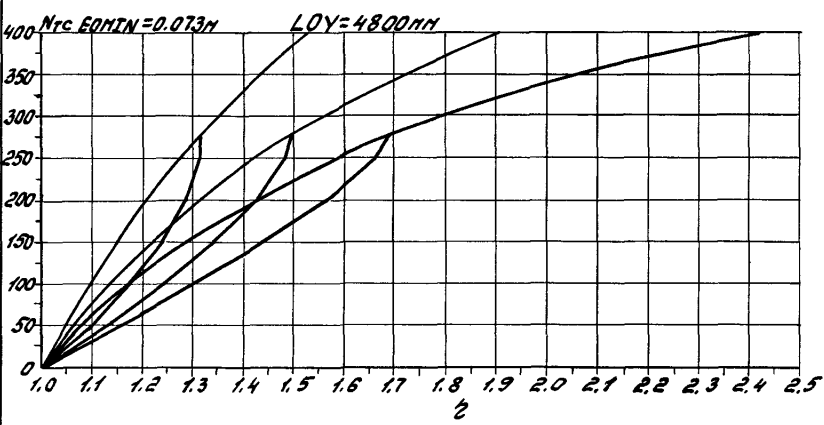
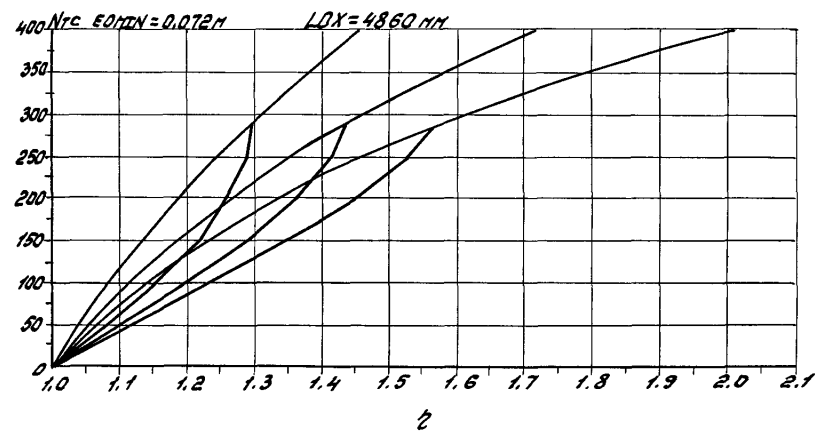
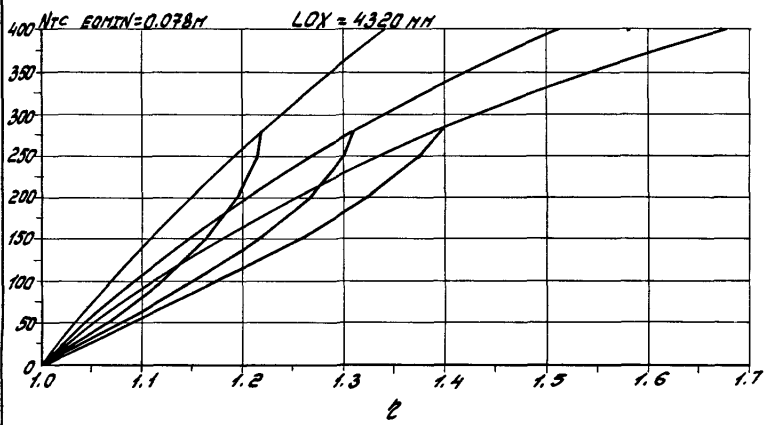

Видеосъём в Демонстрационном центре



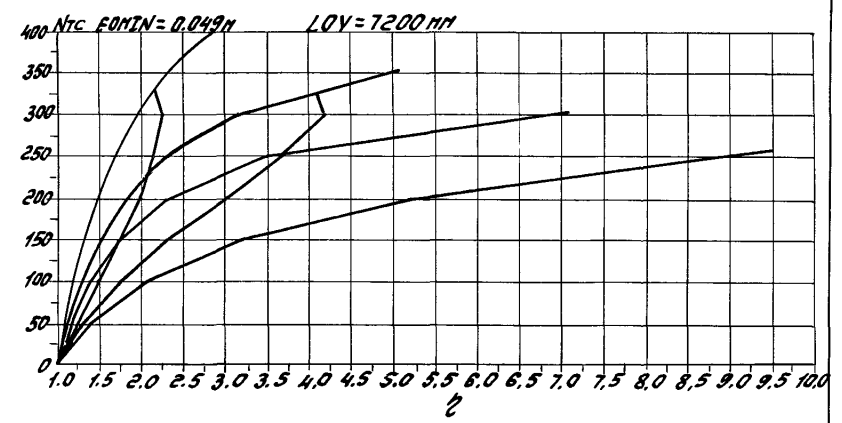
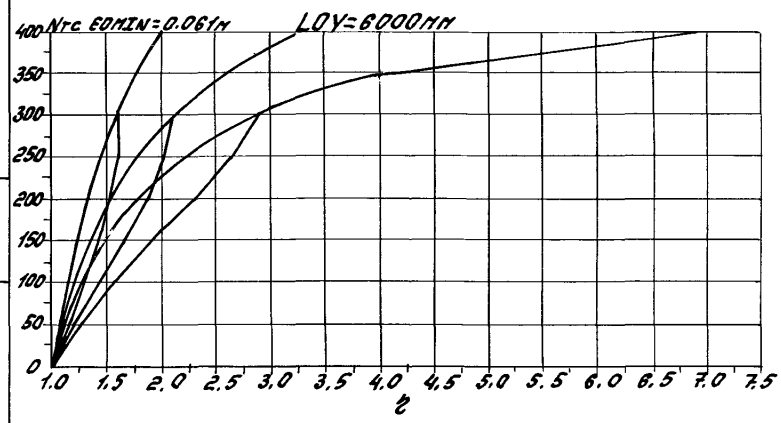
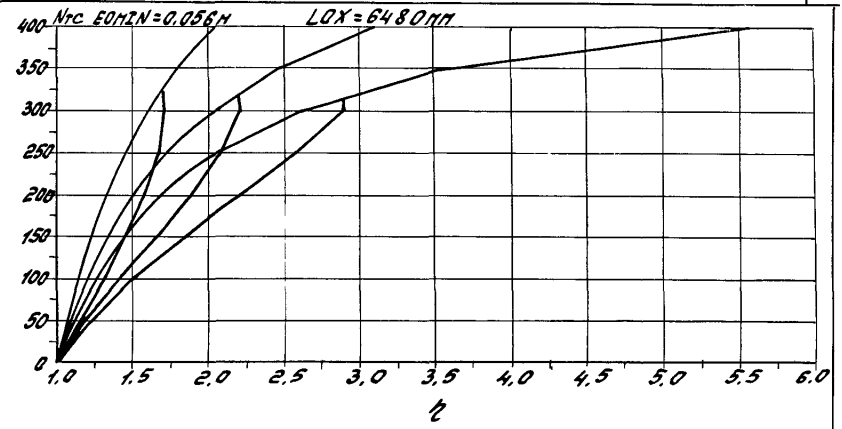
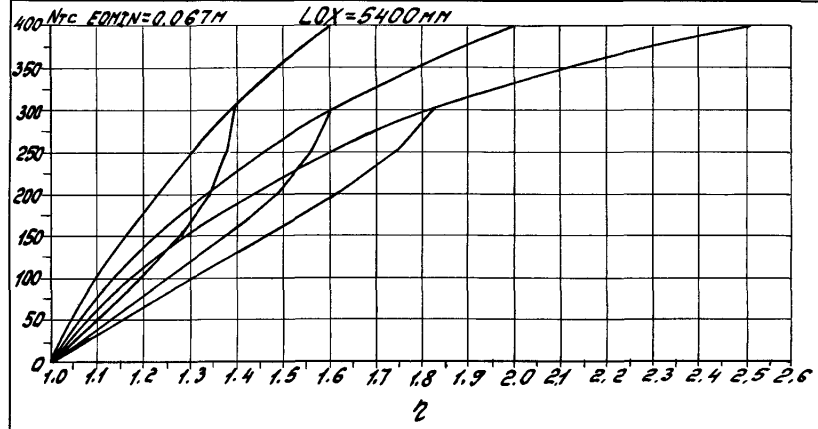

Улб. Нисдед. Тодуца и Дото Баарч улб.А

1.020.1-4 0-9 002

168
-----

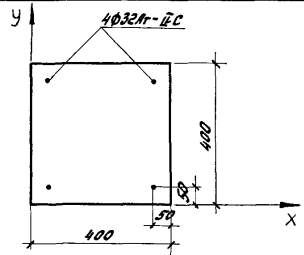
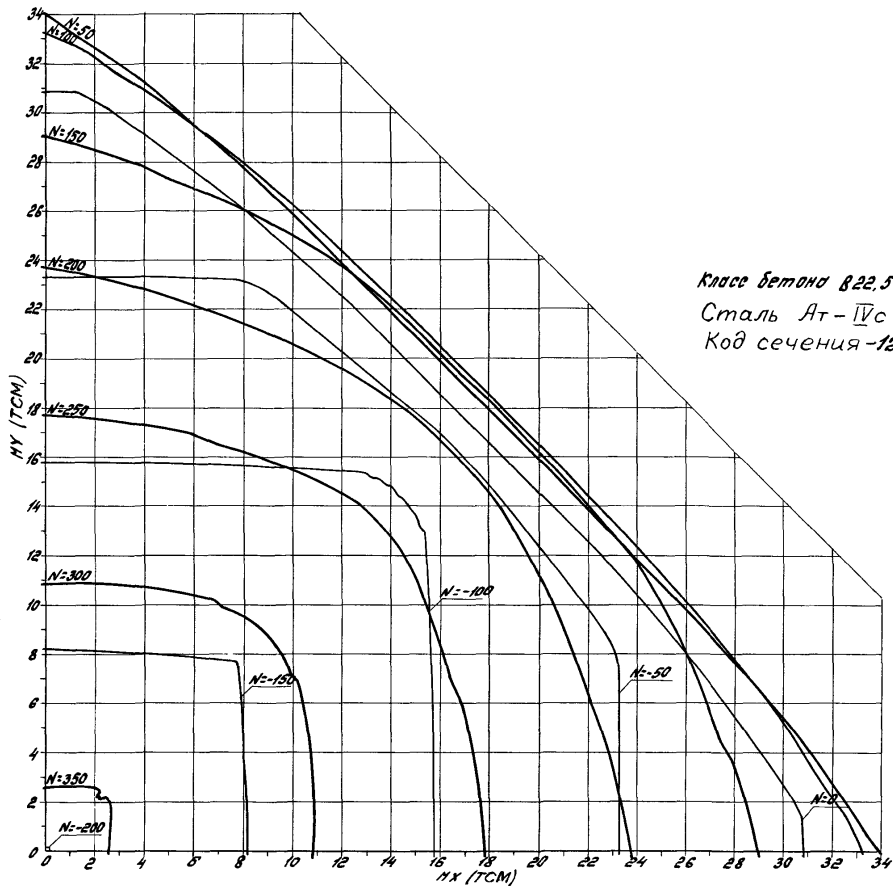

Класс бетона В22,5 ( $R_b = 14.3 \text{ МПа}$  при учёте  $\gamma_{b2} = 1.10$ )  
 Сталь Ат-IVС  
 Код сечения -122а

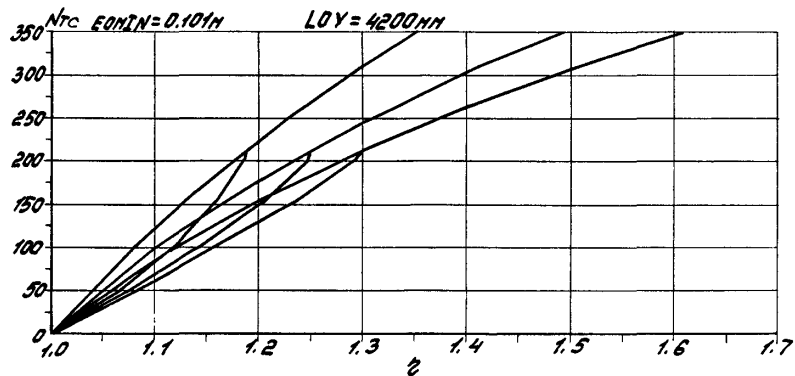
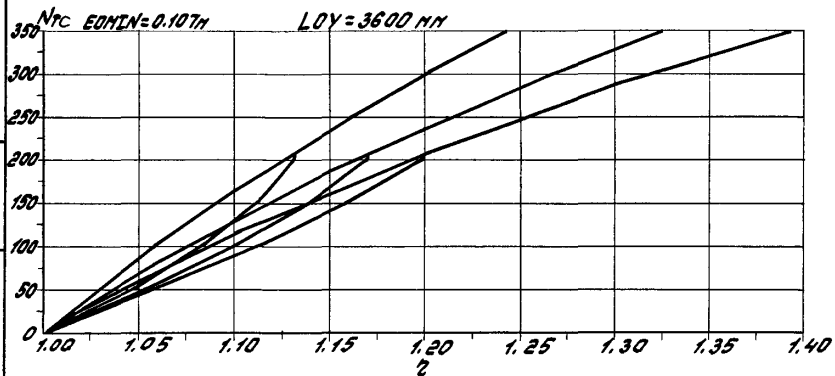
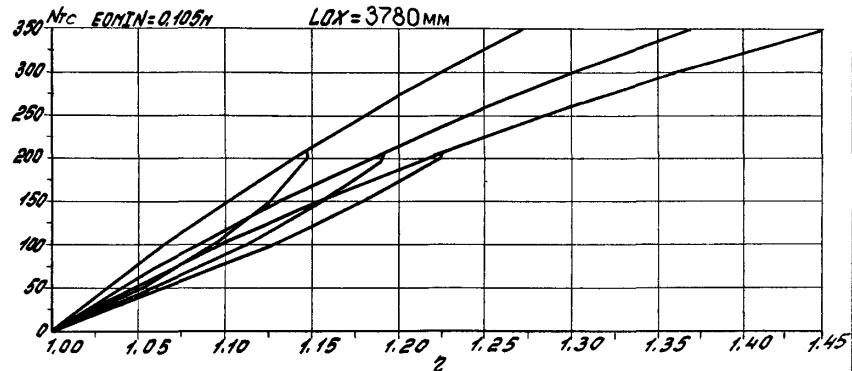
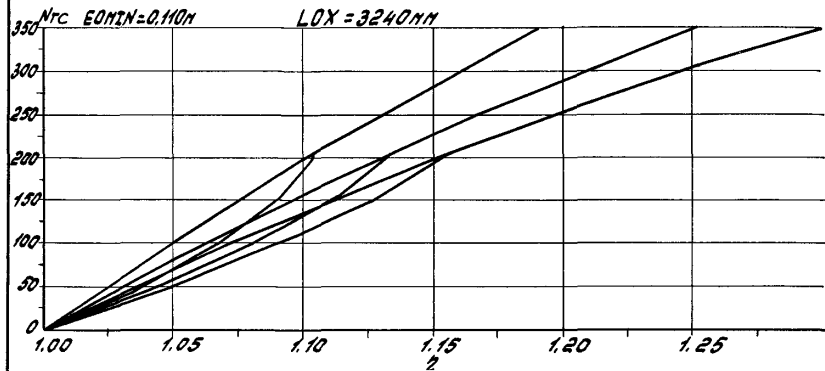

1/16. А.С. Паша, Институт «Сибирский университет»

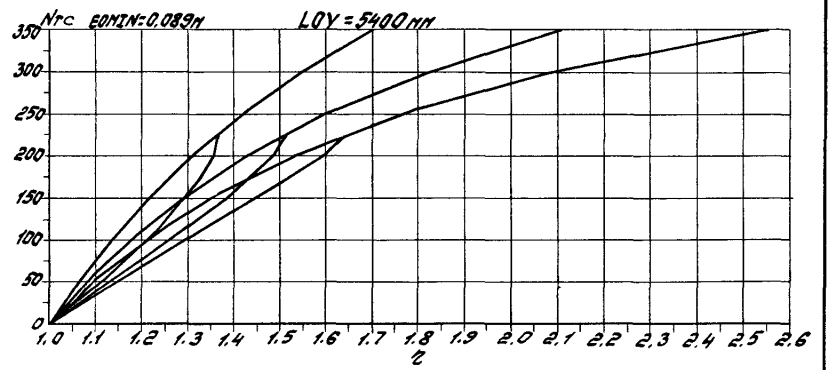
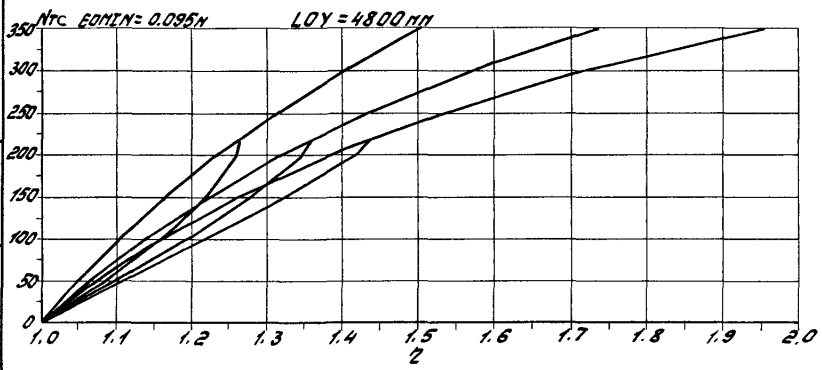
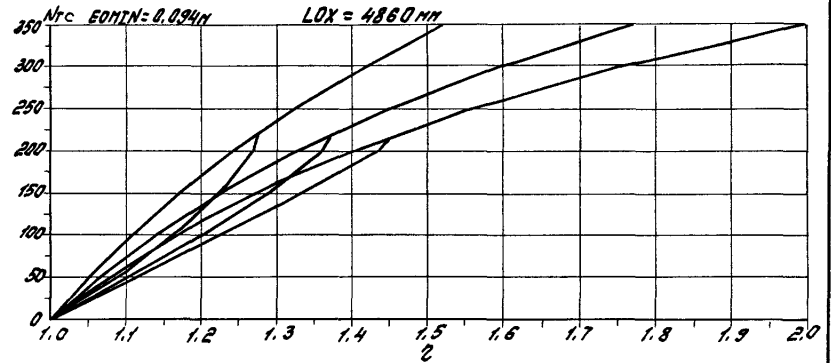
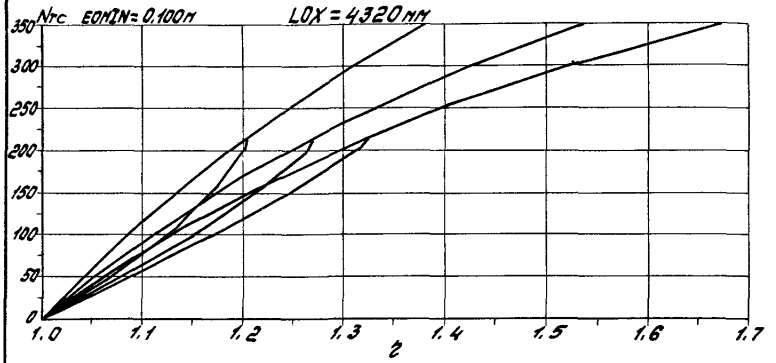

Умб. п'рвобд. П'рвобд. у б'рвм б'рвм ум

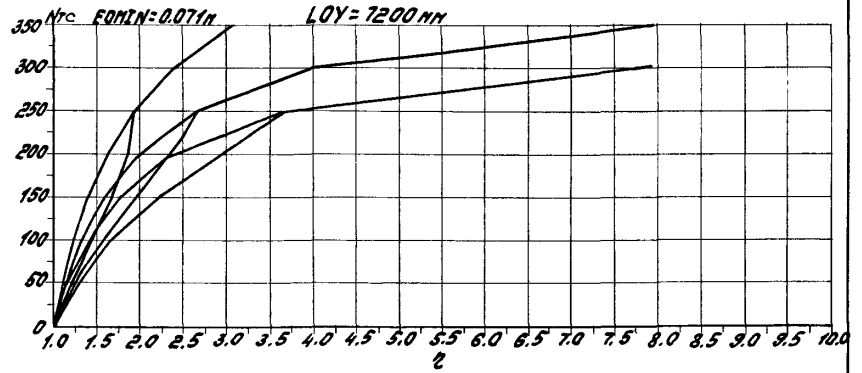
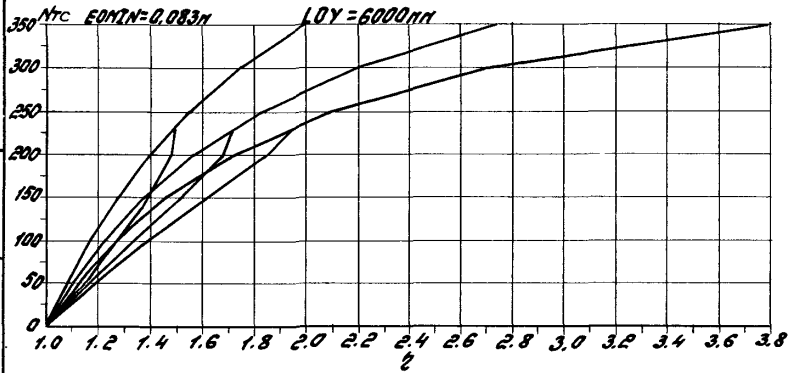
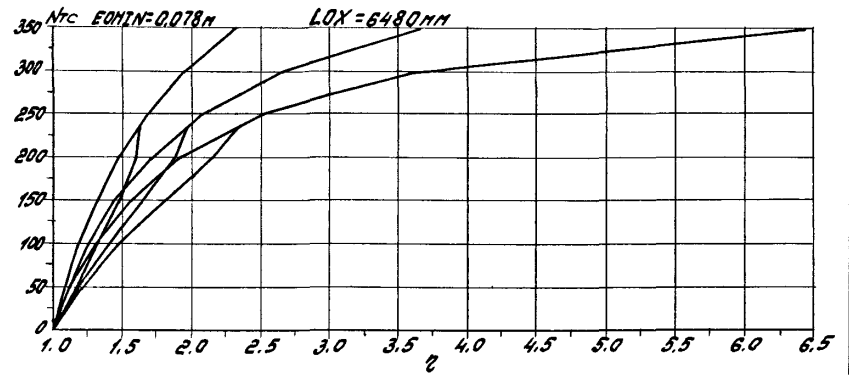
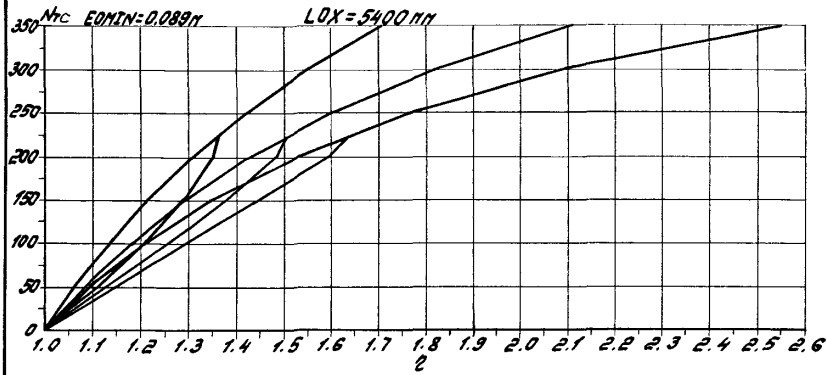

Укв. №: невід. Підписує у Вісник Стом. Укр. А

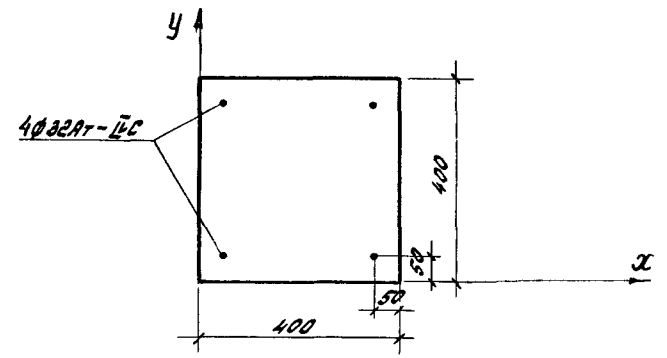
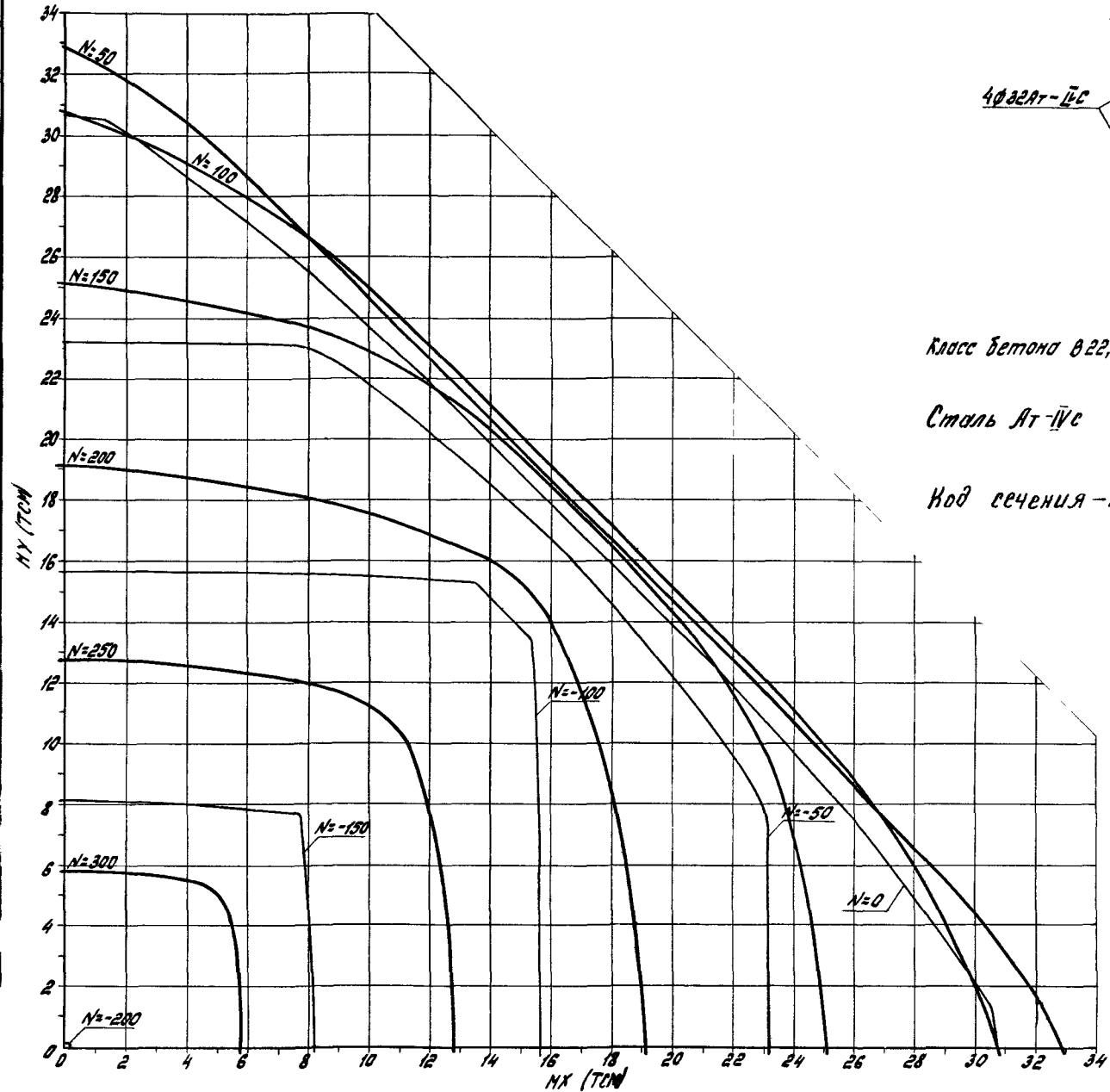

Класс бетона B22,5 ( $R_b = 11$  МПа при учете  $\gamma_{b2} = 0.90$ )

Сталь А7-IVc

Код сечения - 122б

Упр. 19 модн. Видеосъём и запись спектров

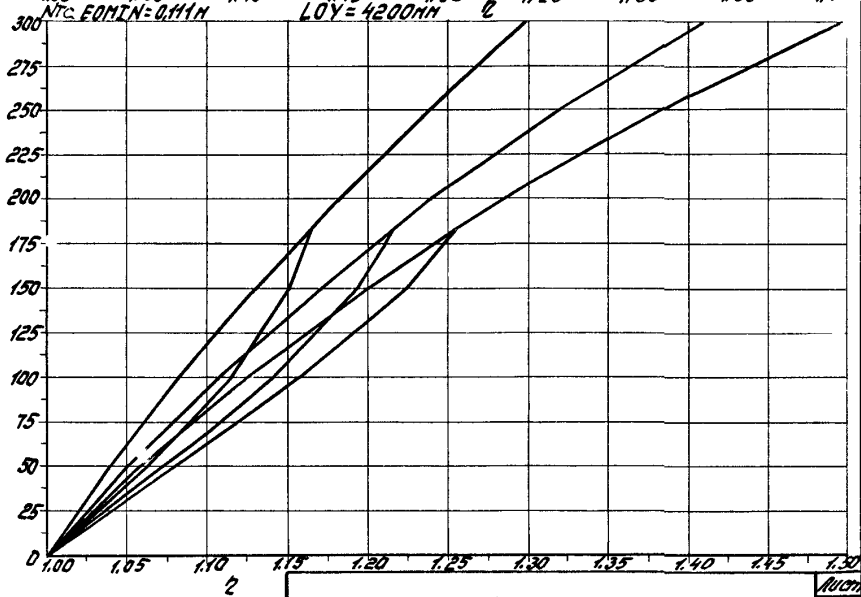
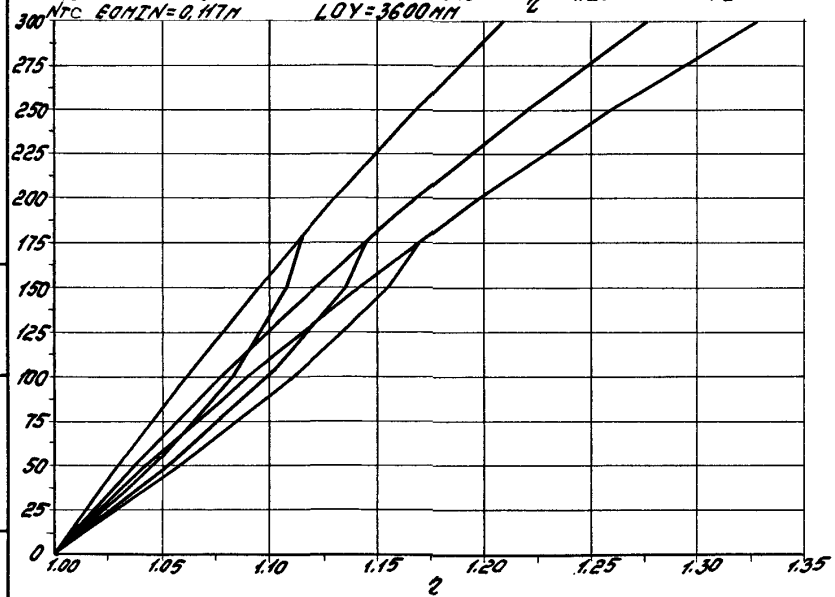
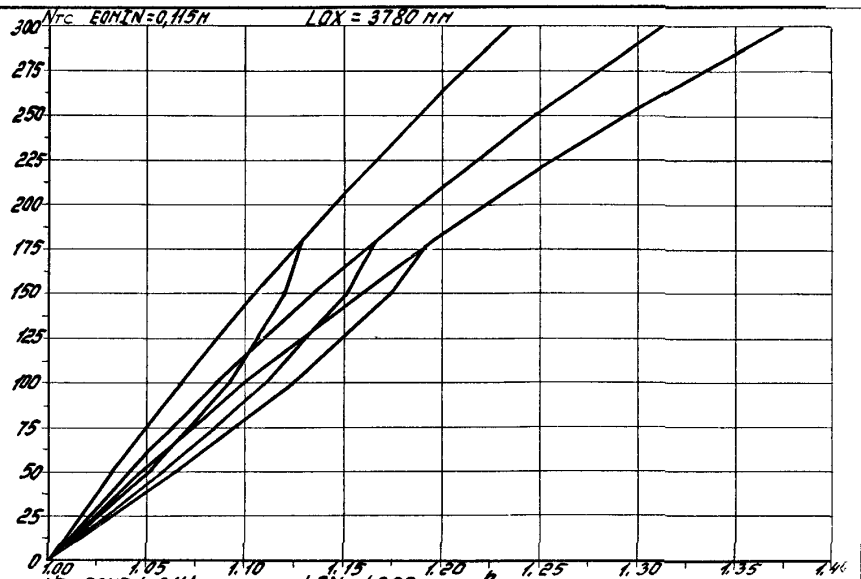
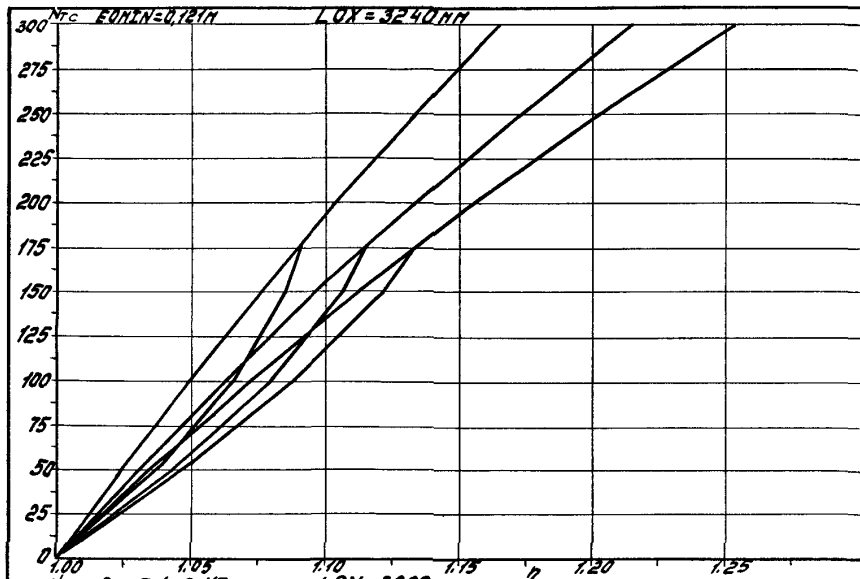

1.020.1-4 0-9 002

174

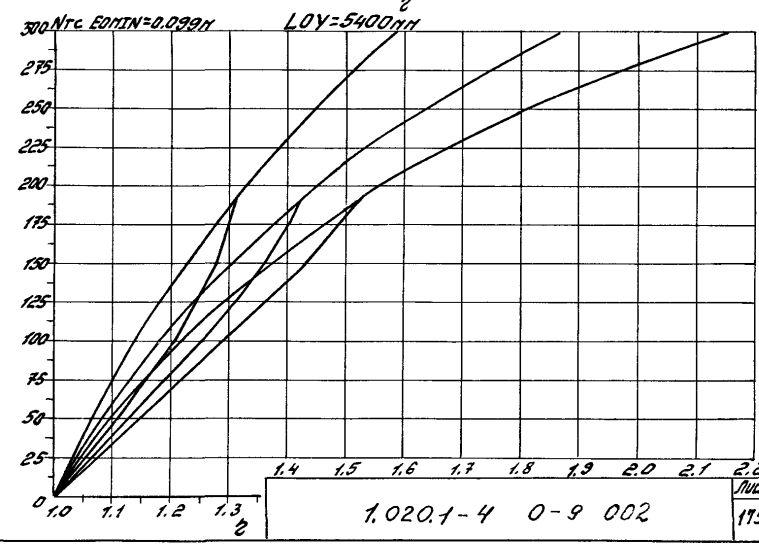
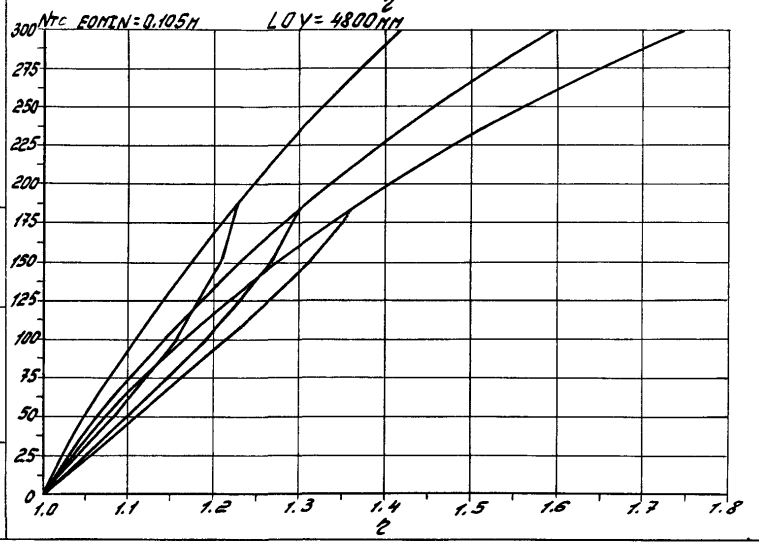
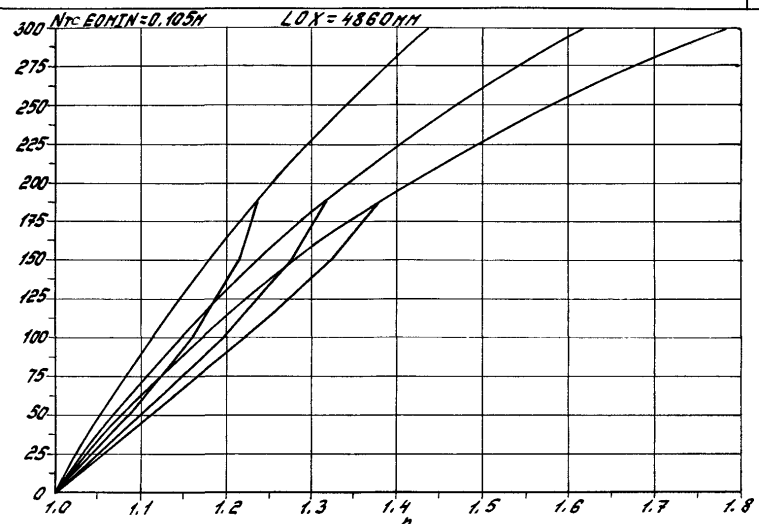
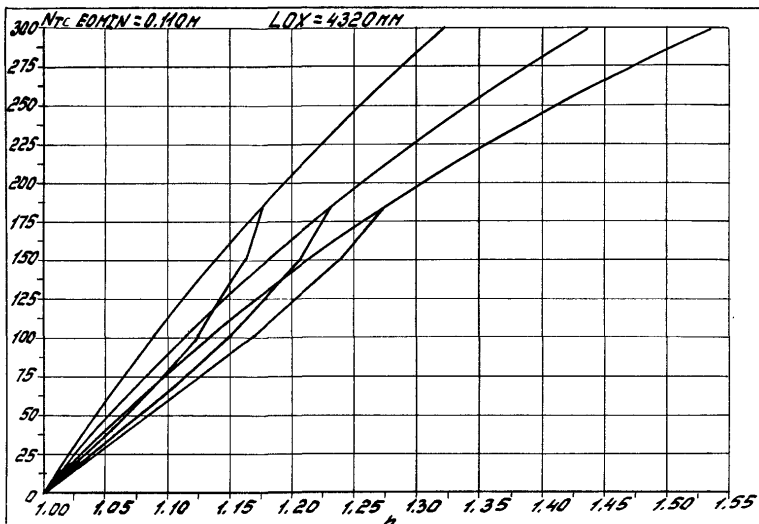

ВЕР. Н. = мм. ШКАЛА В В. И Д. мм. МАСШ. 1

1.020.1-4 0-9 002 175



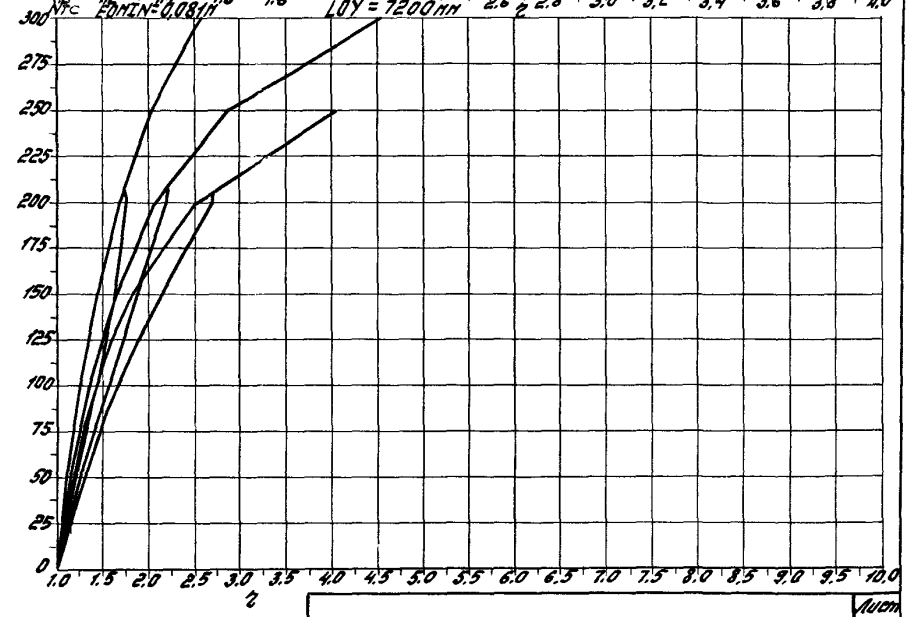
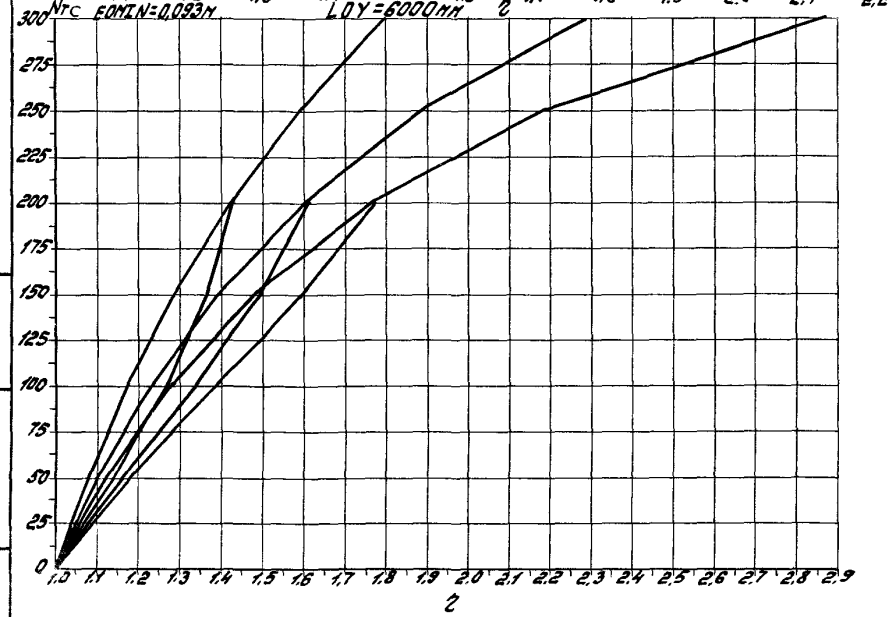
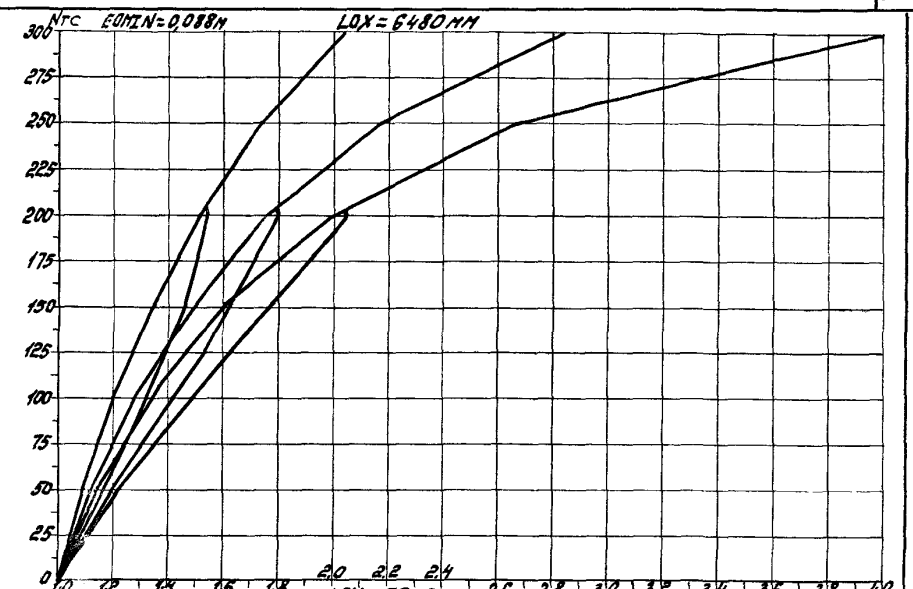
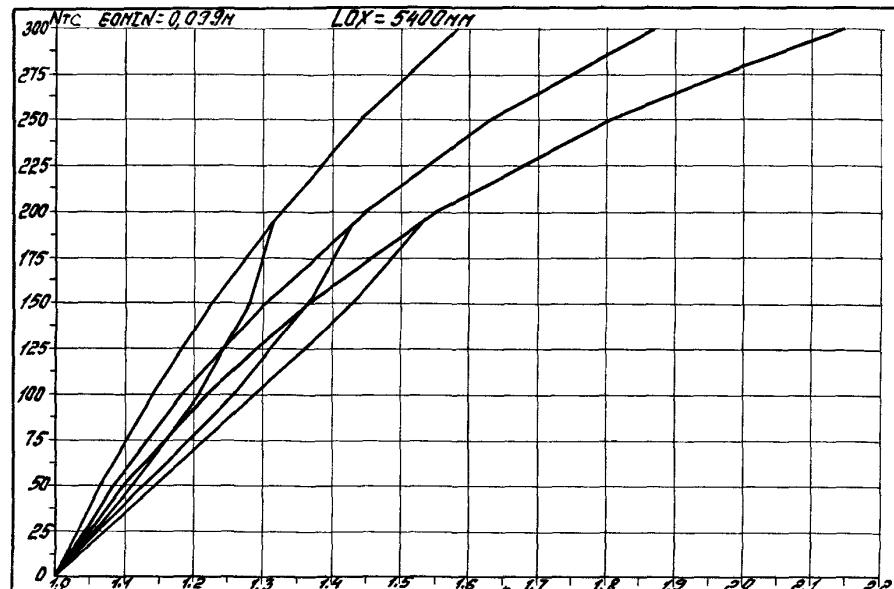

№№ и нач. значений в форме Вспом. таб. №

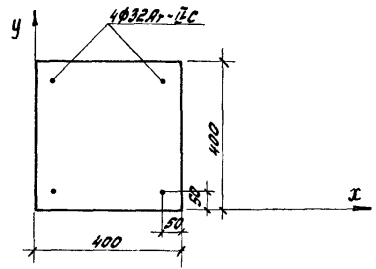
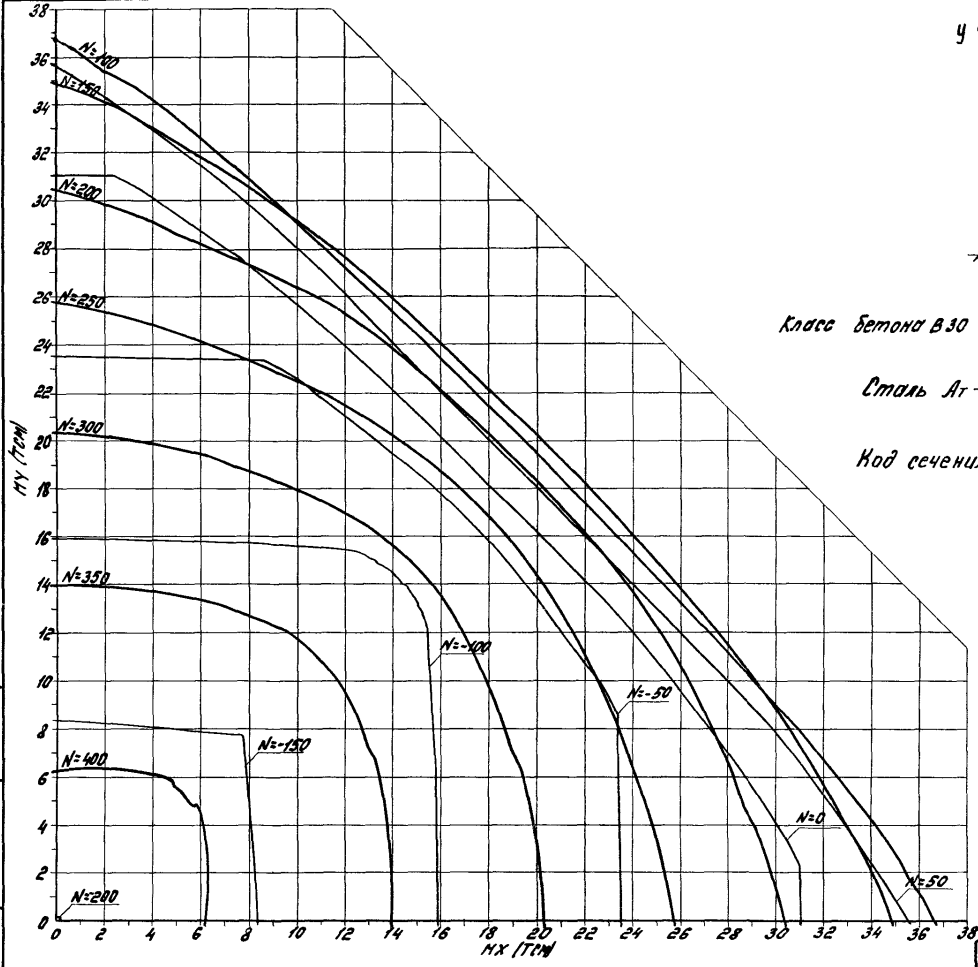

Класс бетона В30 ( $R_b = 18,7 \text{ МПа}$  при учёте  $\gamma_c = 1,10$ )

Сталь А1-Цс

Код сечения - 123а

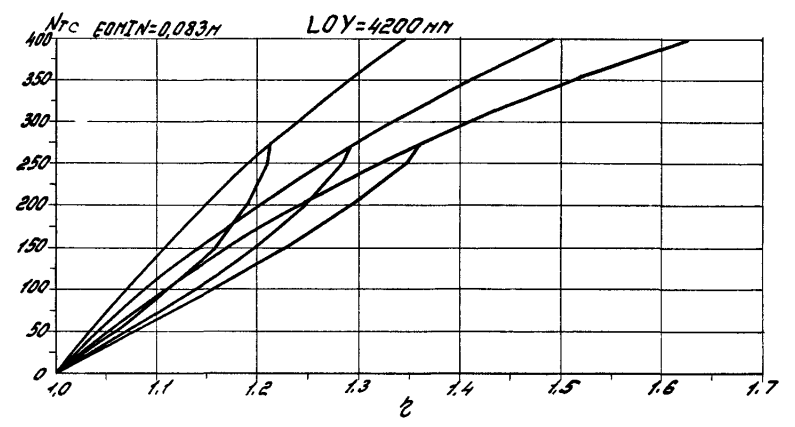
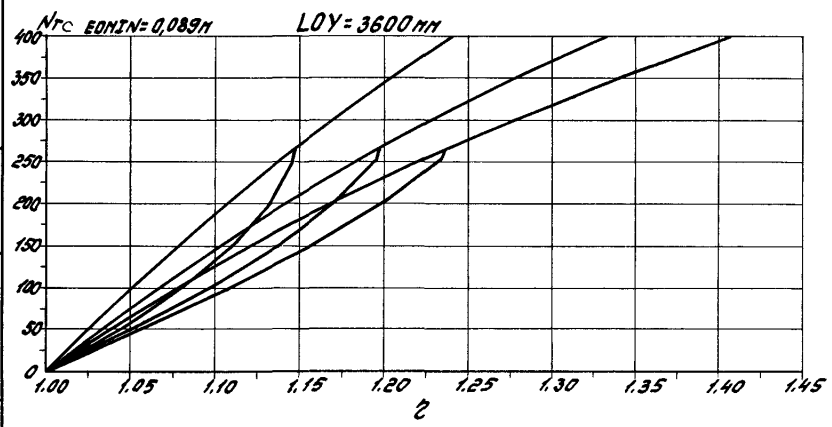
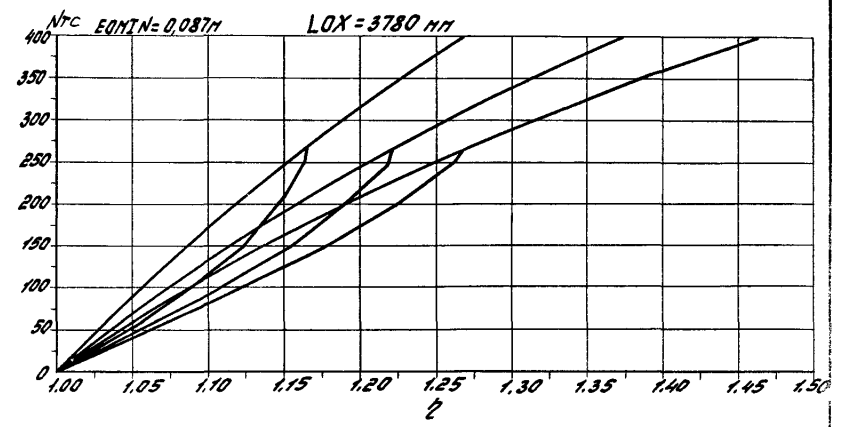
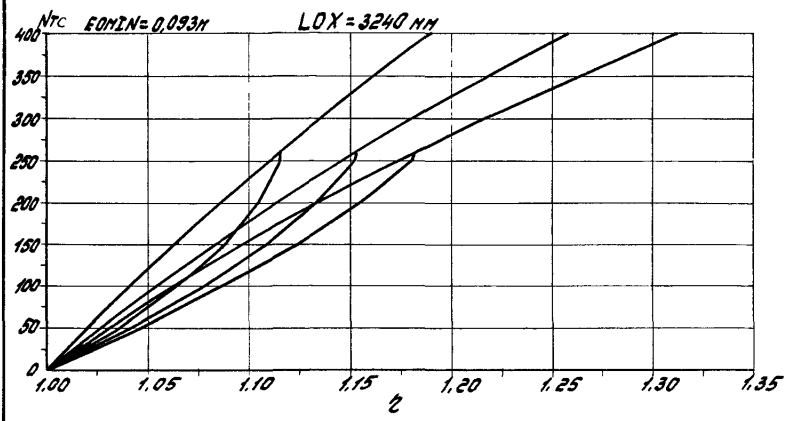

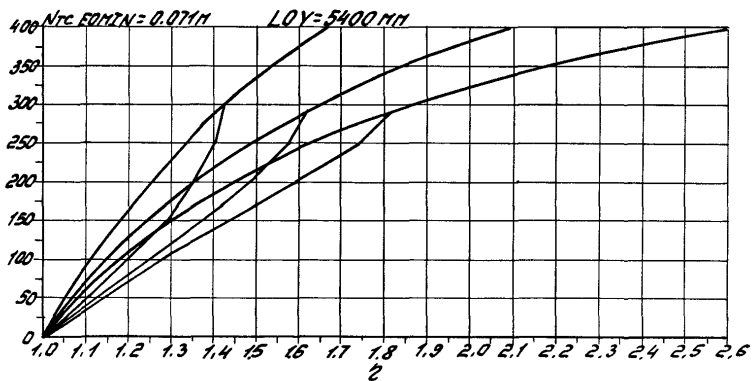
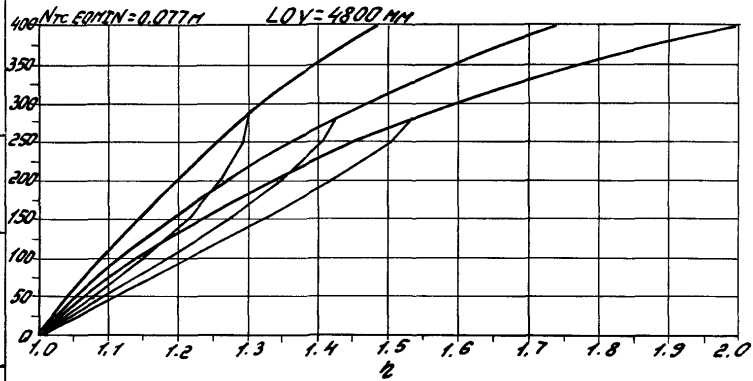
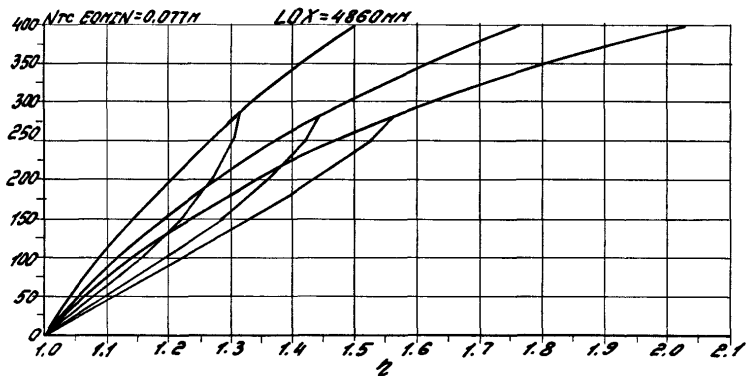
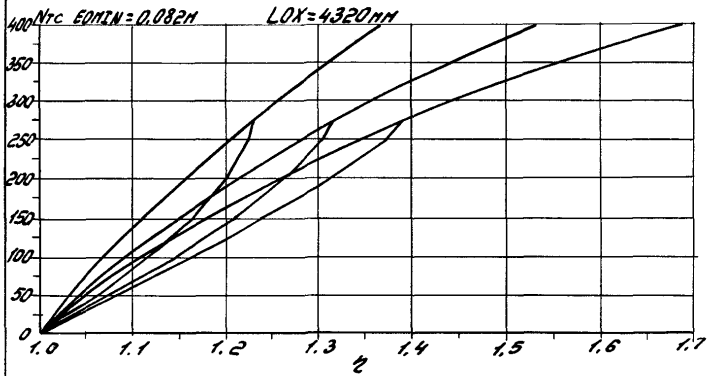

Уш. 11 год. 11 мес. 11 д. 11 ч. 11 м. 11 с.

1.020.1-4 0-9 002 179



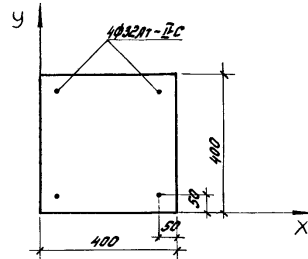
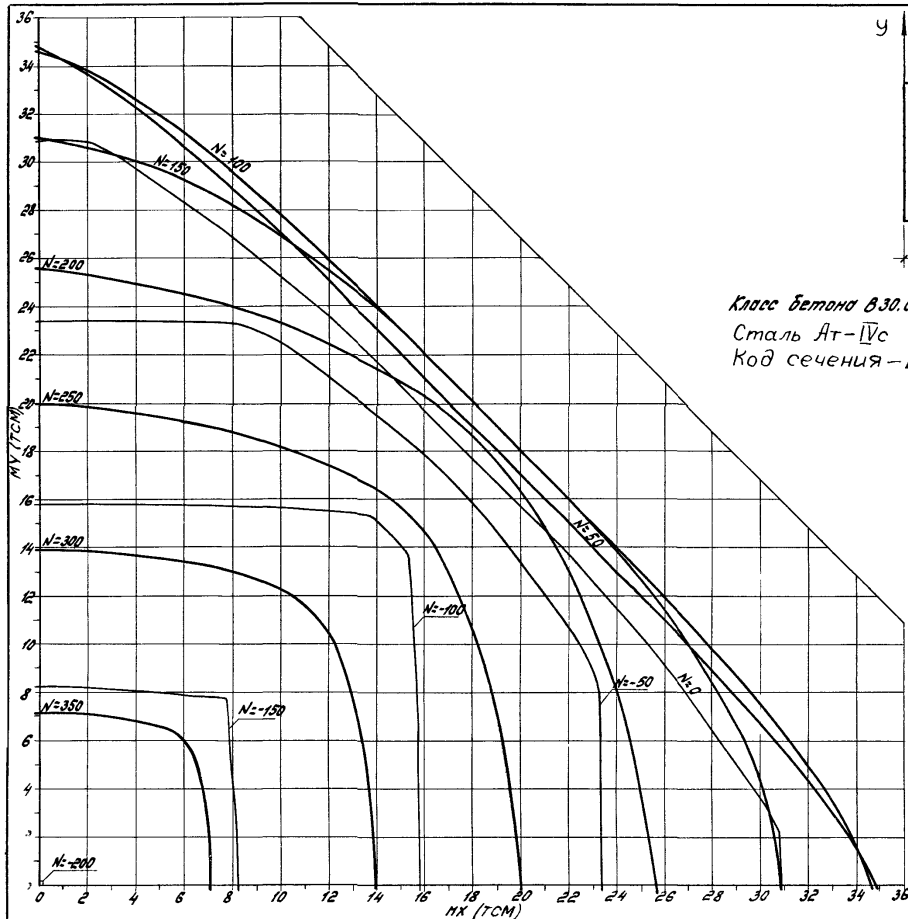

Класс бетона В30.0 ( $R_b = 15.3 \text{ МПа}$  при учёте  $\gamma_{b2} = 0.90$ )  
 Сталь АТ-IVс  
 Код сечения - 123Б

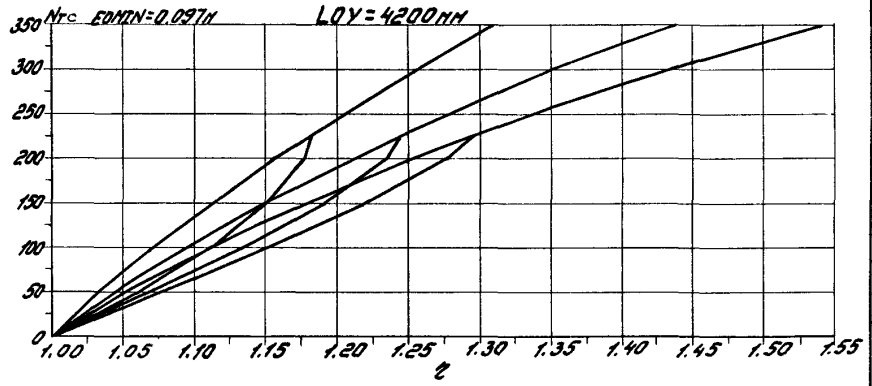
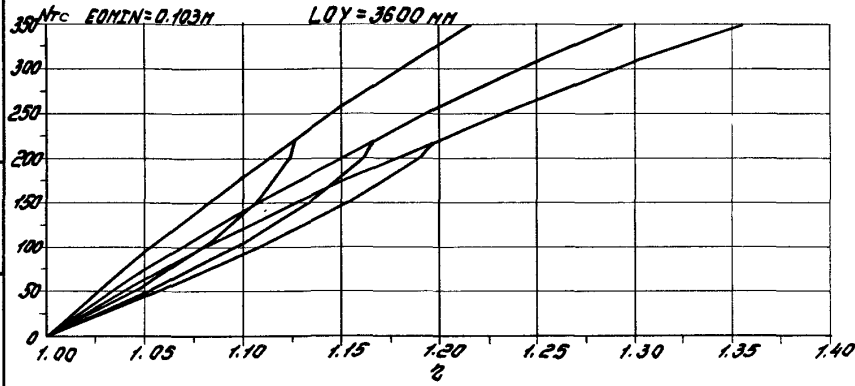
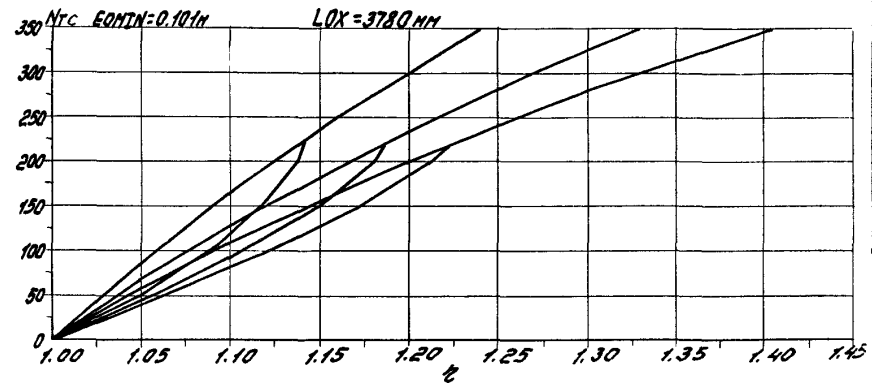
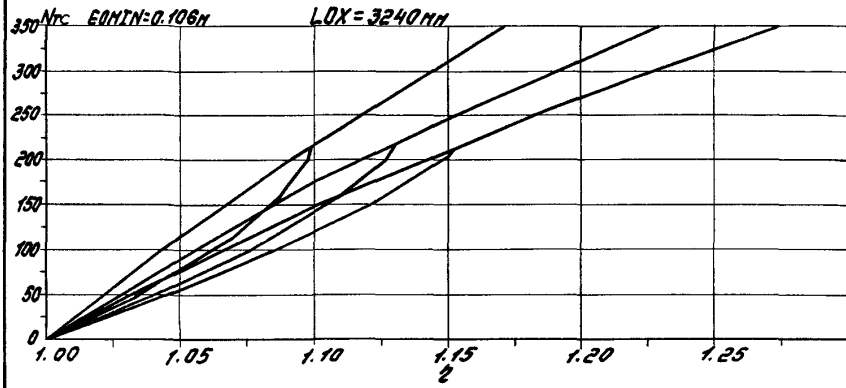

Вид. 1.0201-4 0-9 002

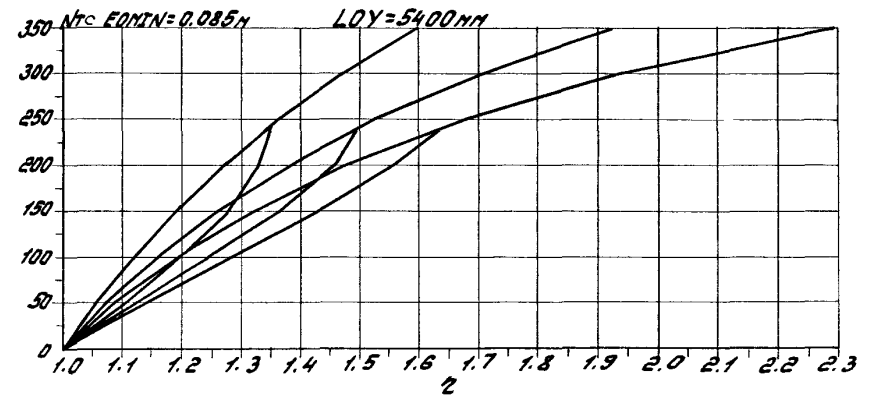
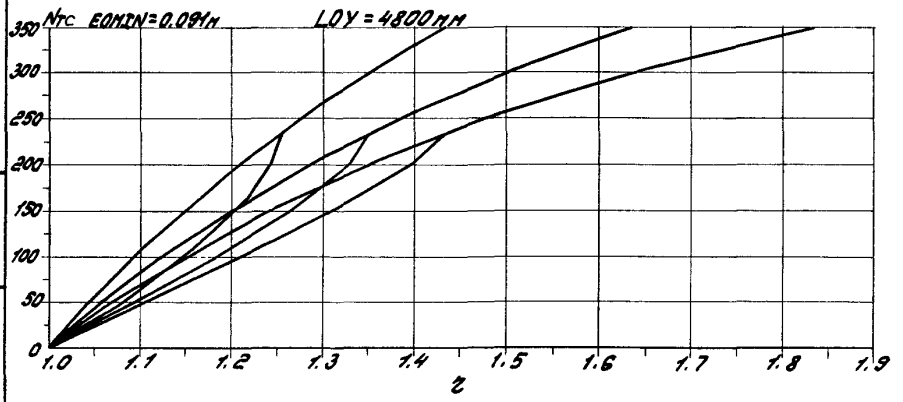
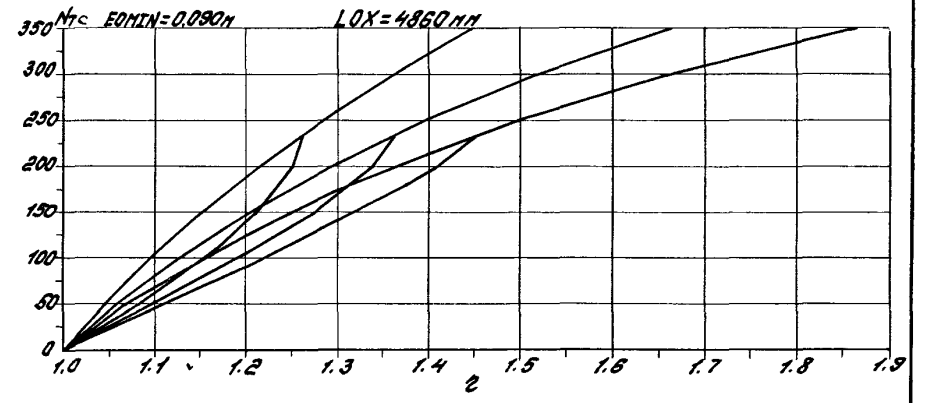
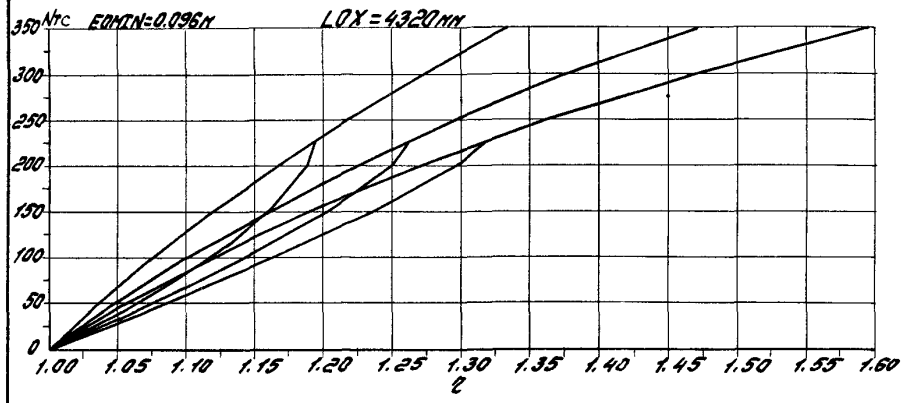



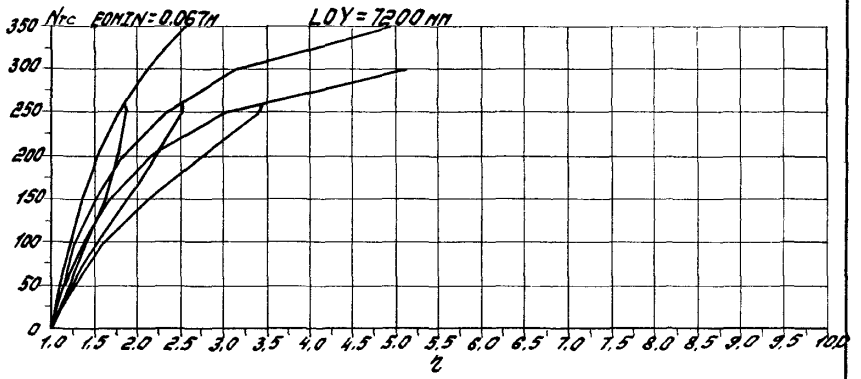
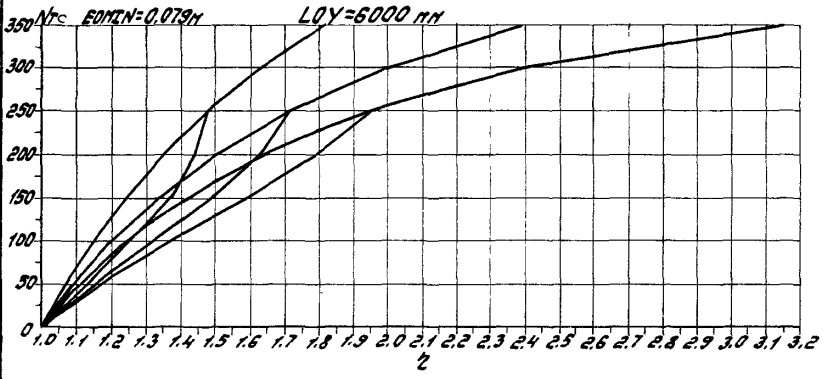
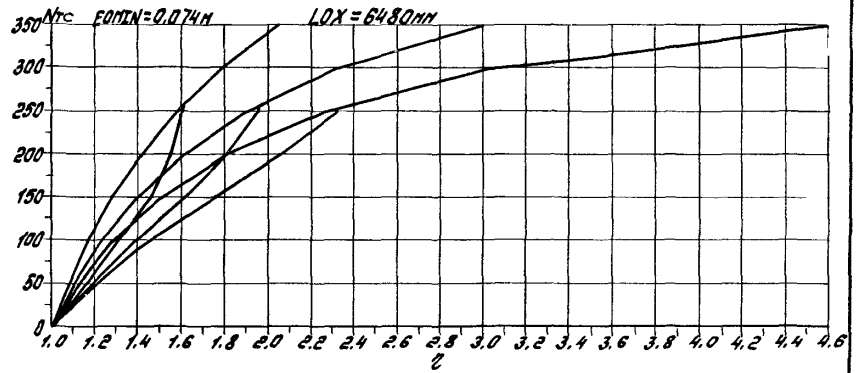
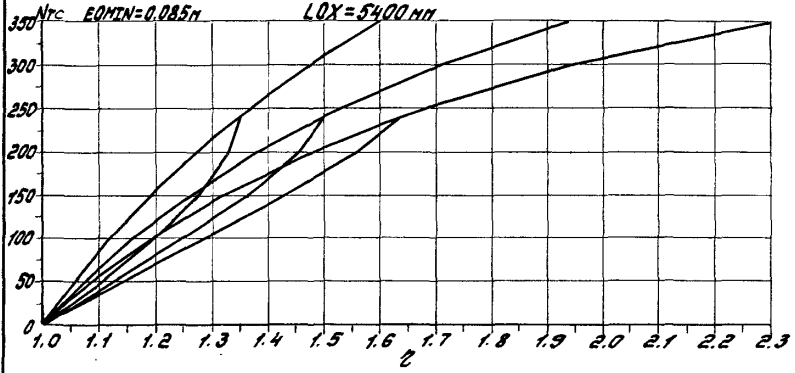

Упр. 19-10001, Проф. 10001, 10001, 10001, 10001

1020.1-4 0-9 002	184
------------------	-----

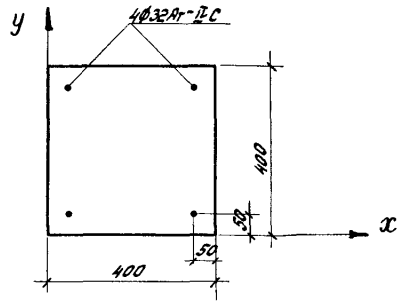
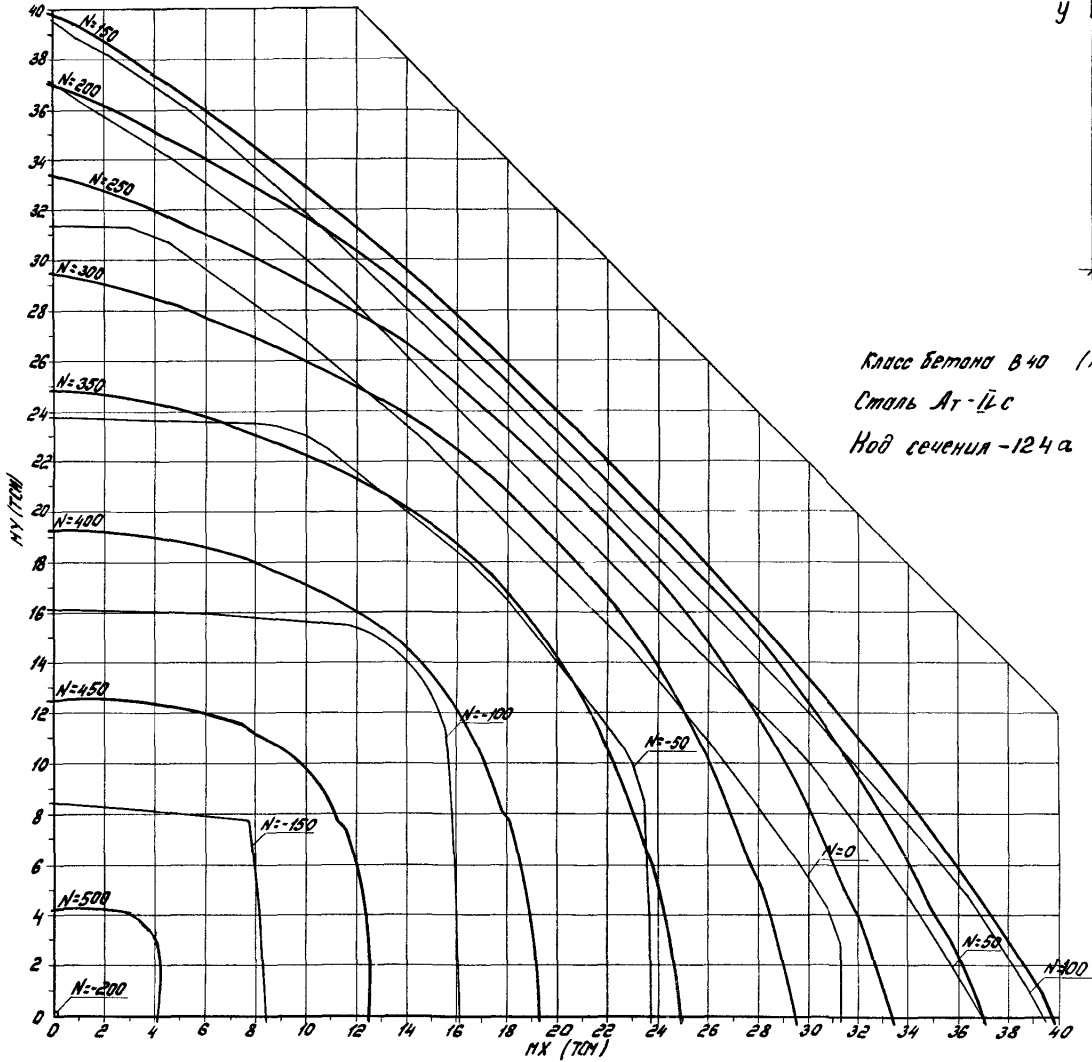

Класс бетона В40 ( $R_b = 24,2$  МПа при учёте  $\gamma_{b2} = 1,10$ )  
 Сталь АТ-ЦС  
 Мод сечения -124 а

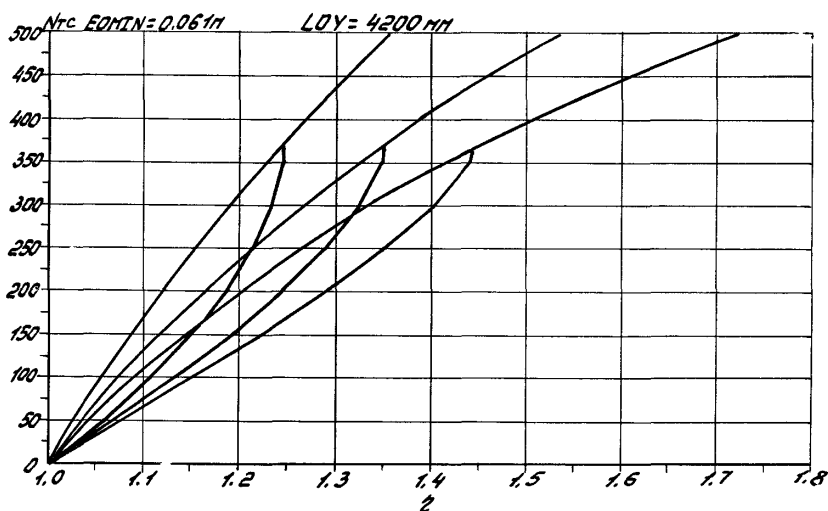
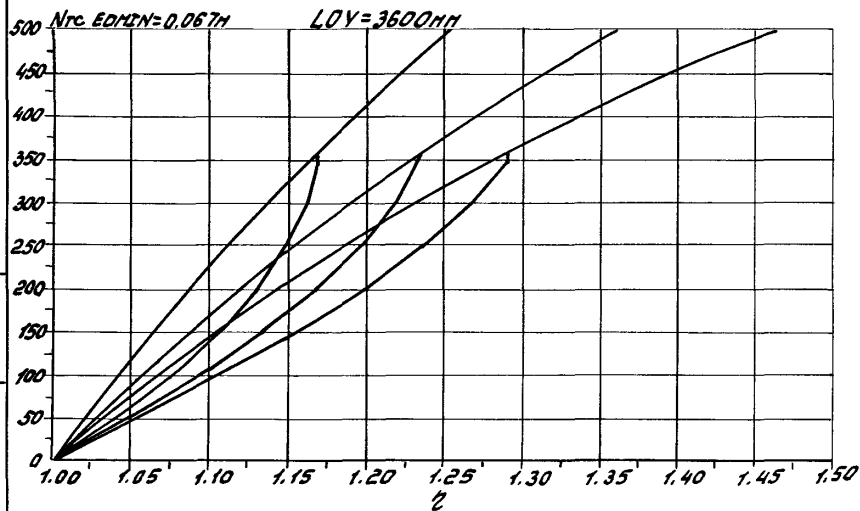
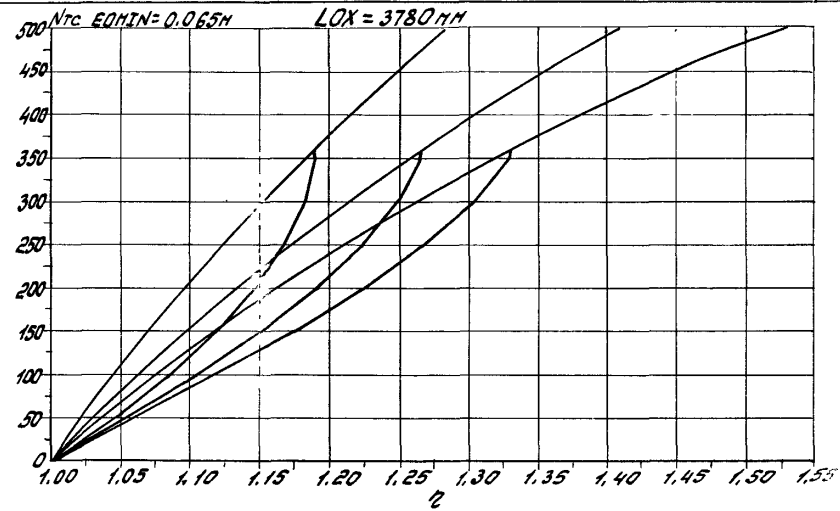
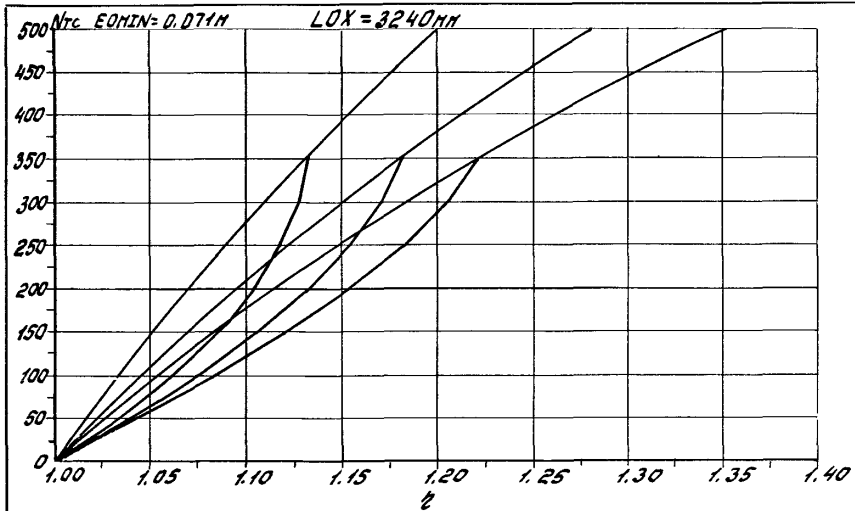

1.020.1-4 0-9 002

186

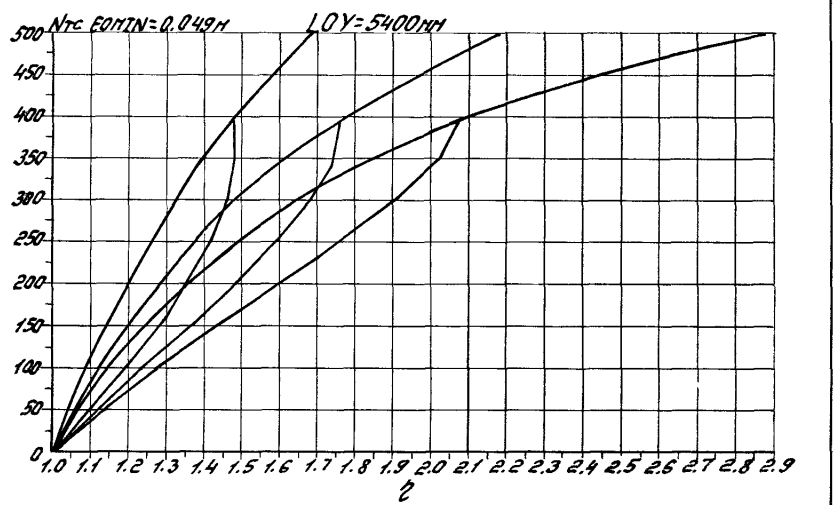
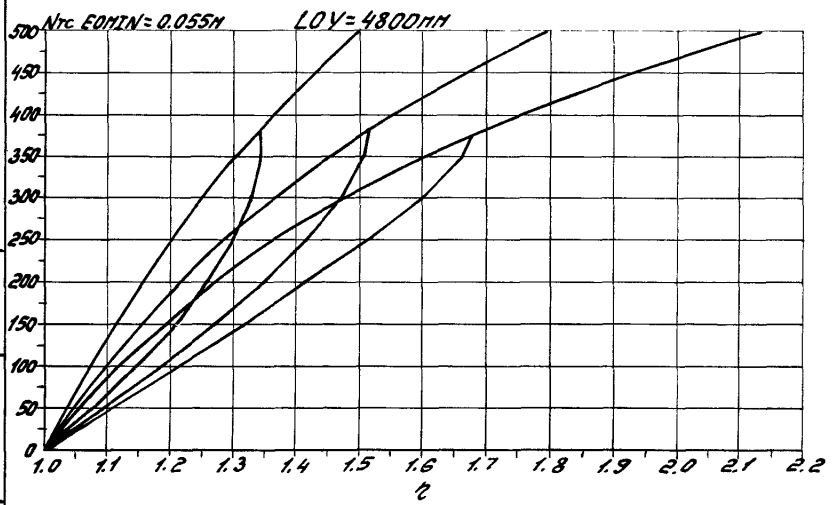
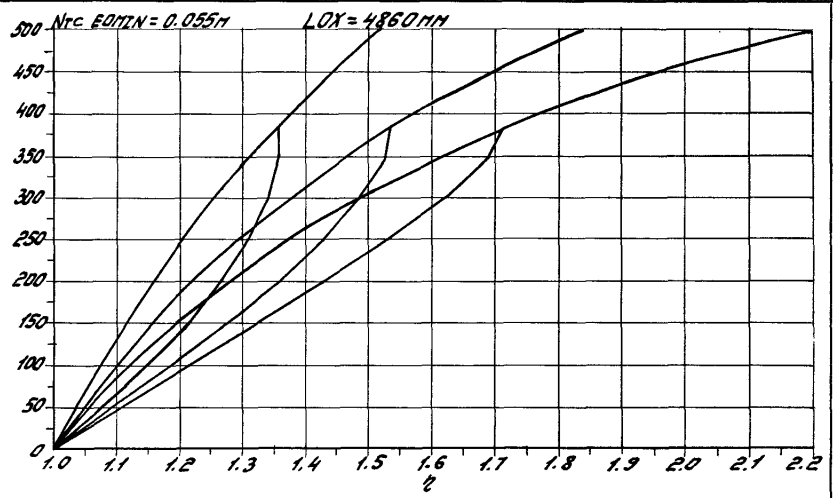
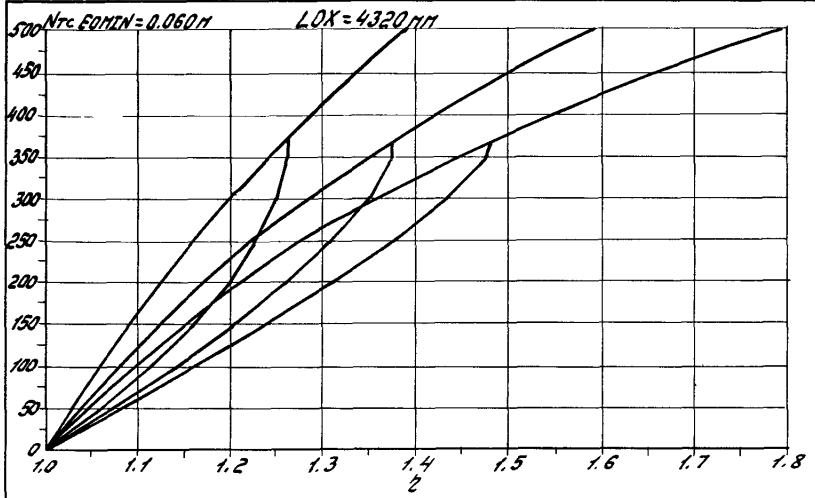

Уч. записи, Подписи

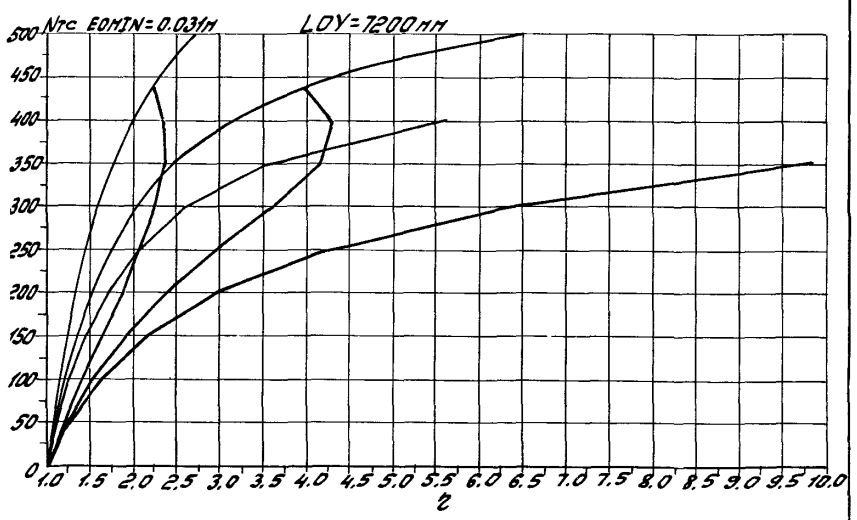
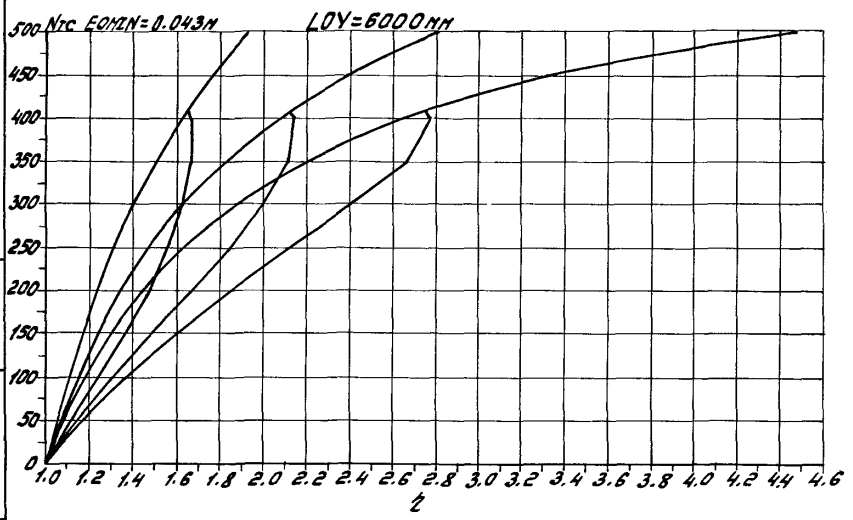
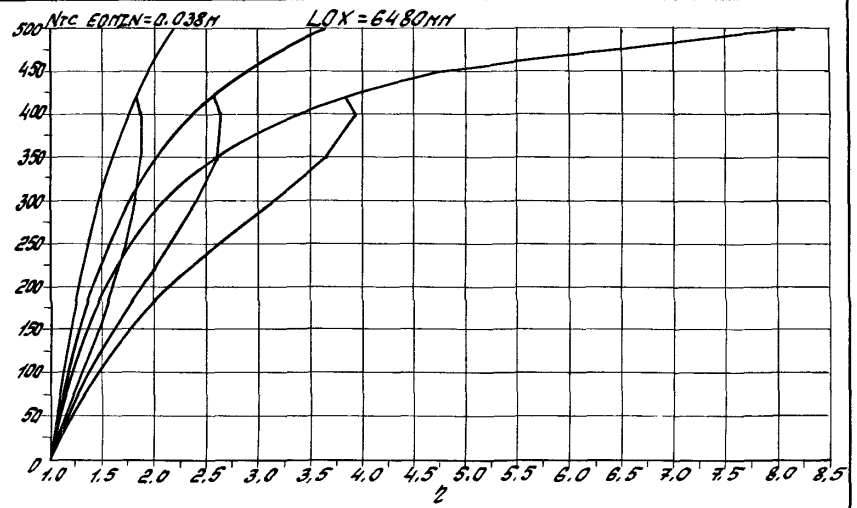
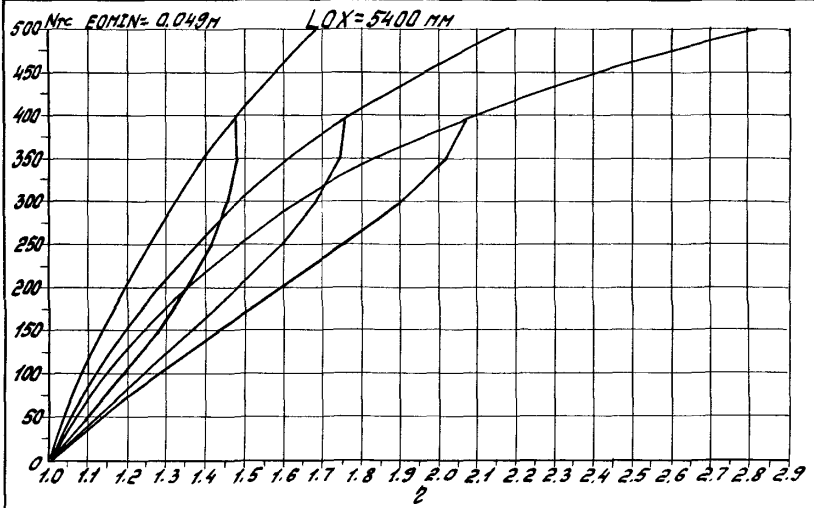

Указ. на накл. плоскости у донной части шара. см. в. в. в.

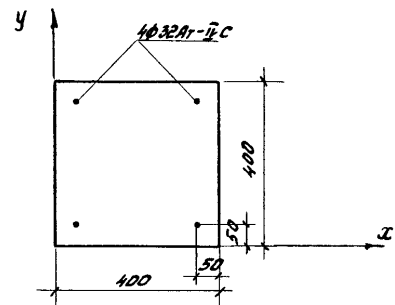

Класс бетона В40 ( $R_b = 1,8 \text{ МПа}$  при учёте  $\gamma_{b2} = 0,90$ )

Сталь А1-III

Код сечения - 1248

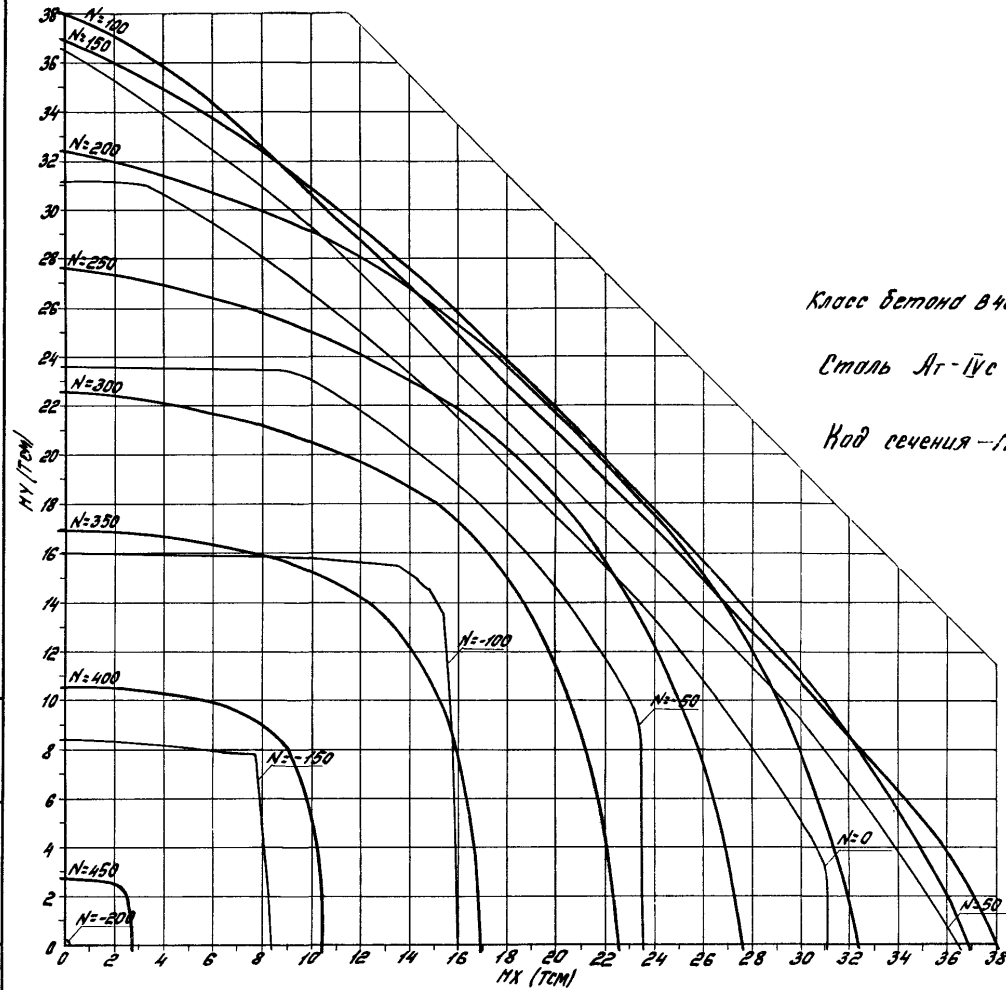

Выборы и сорта стали

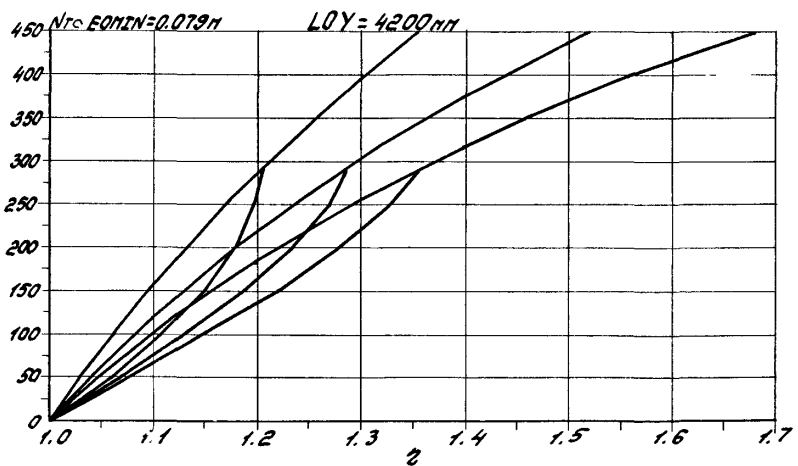
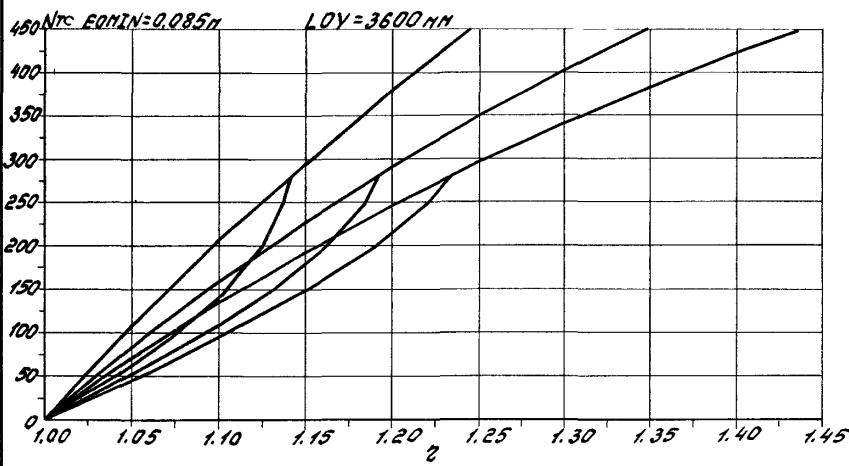
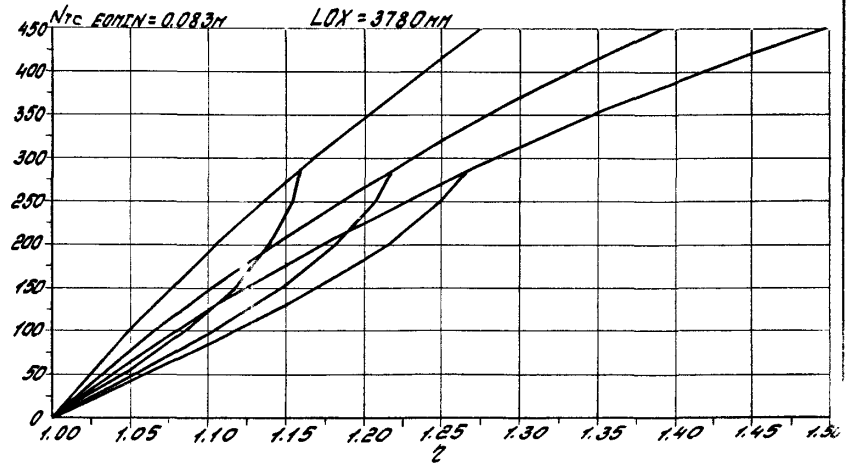
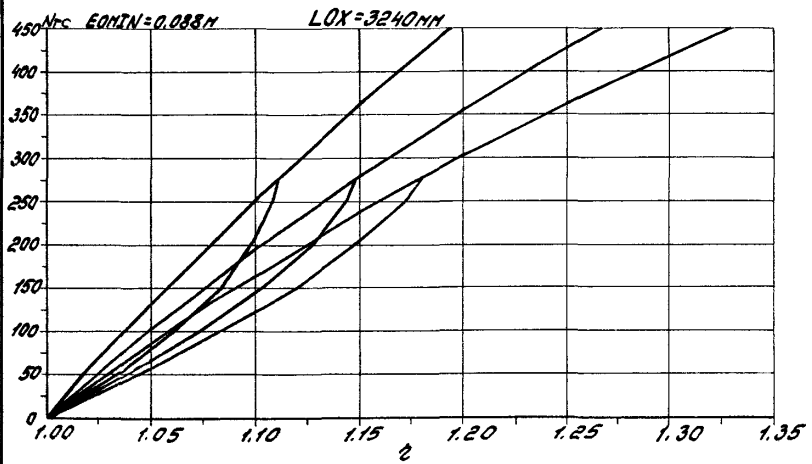

Мат. №: 1020.1-4 0-9 002

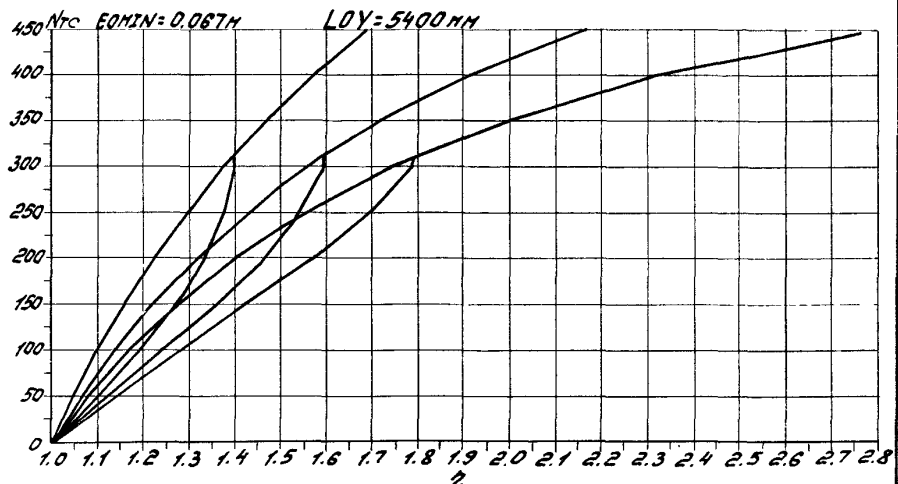
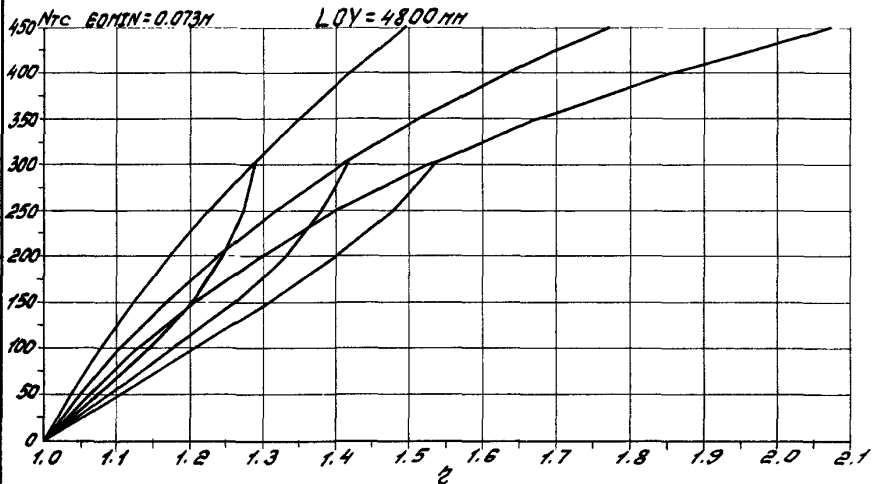
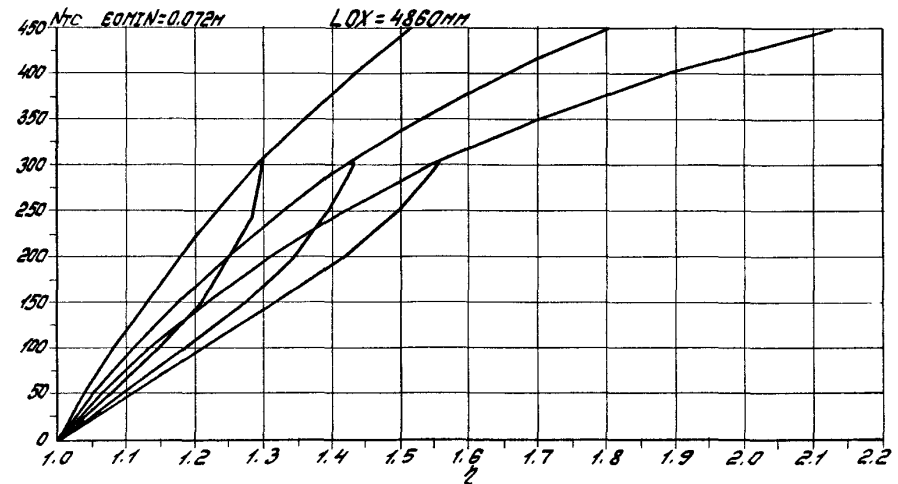
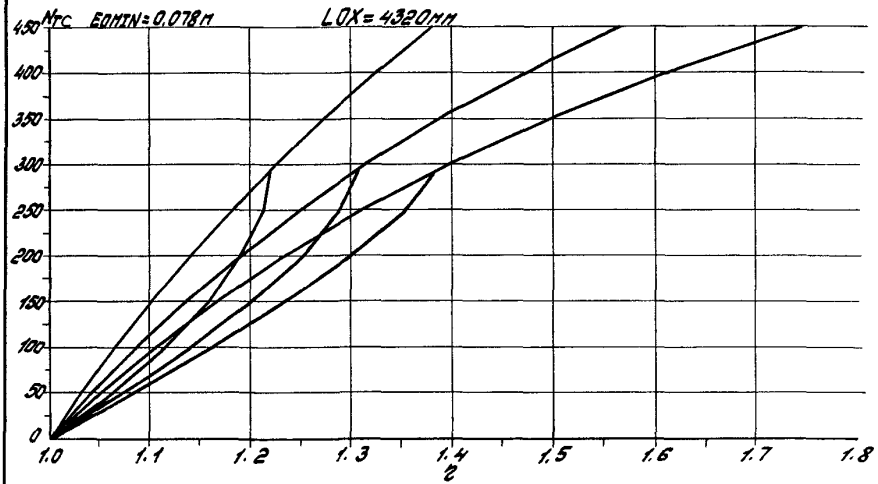

Указанная нагрузка в кг/м²



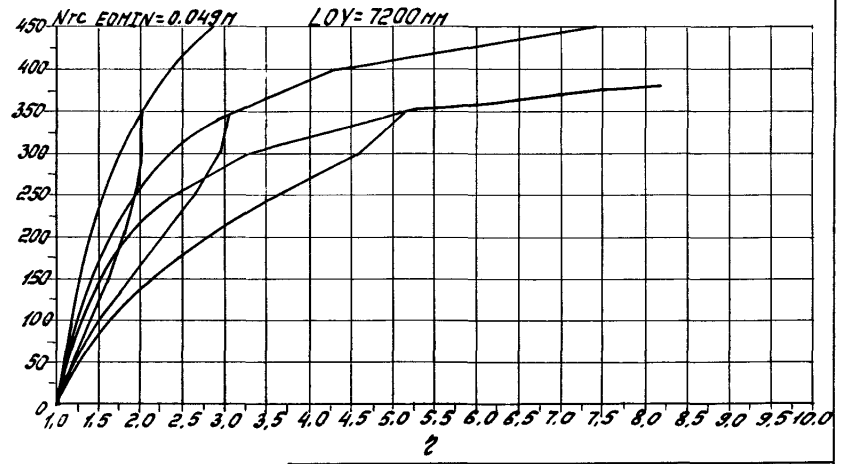
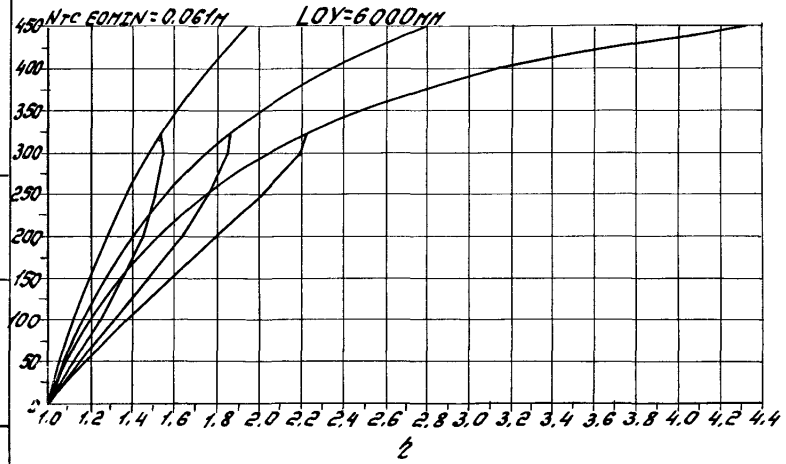
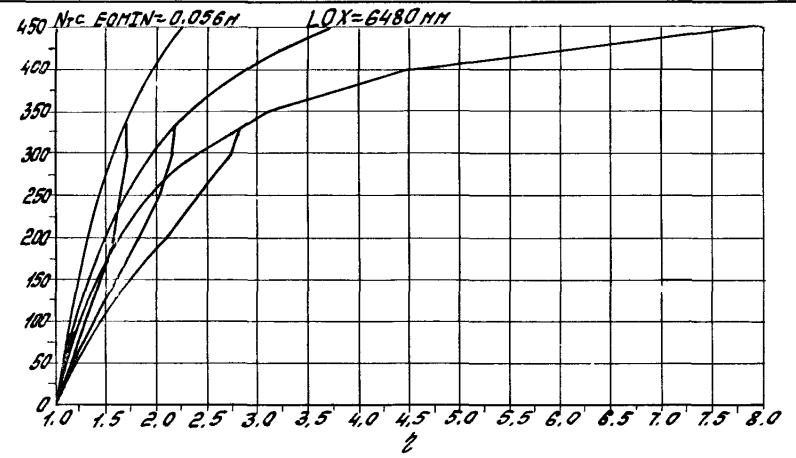
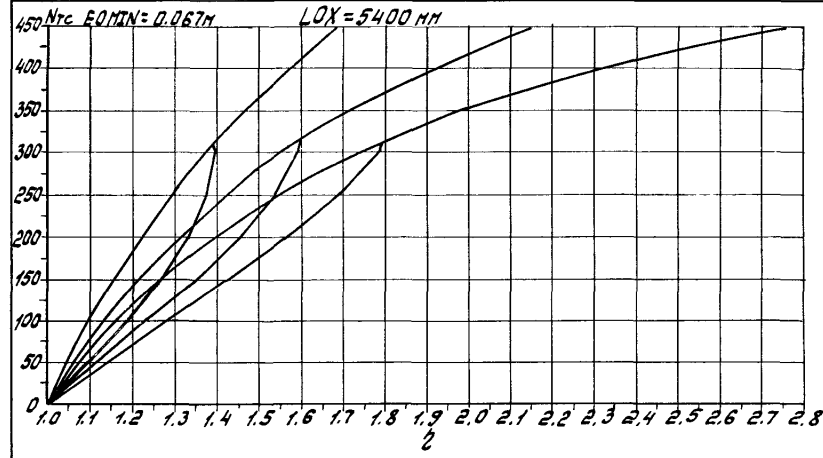

1116. Аноды / Anodes in Barro / Barro / Anodes

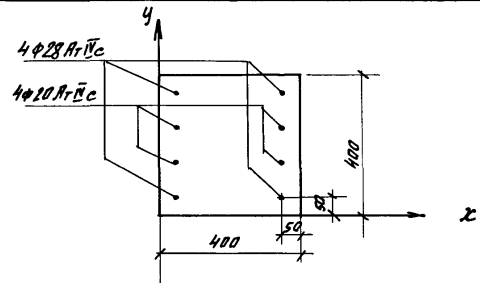
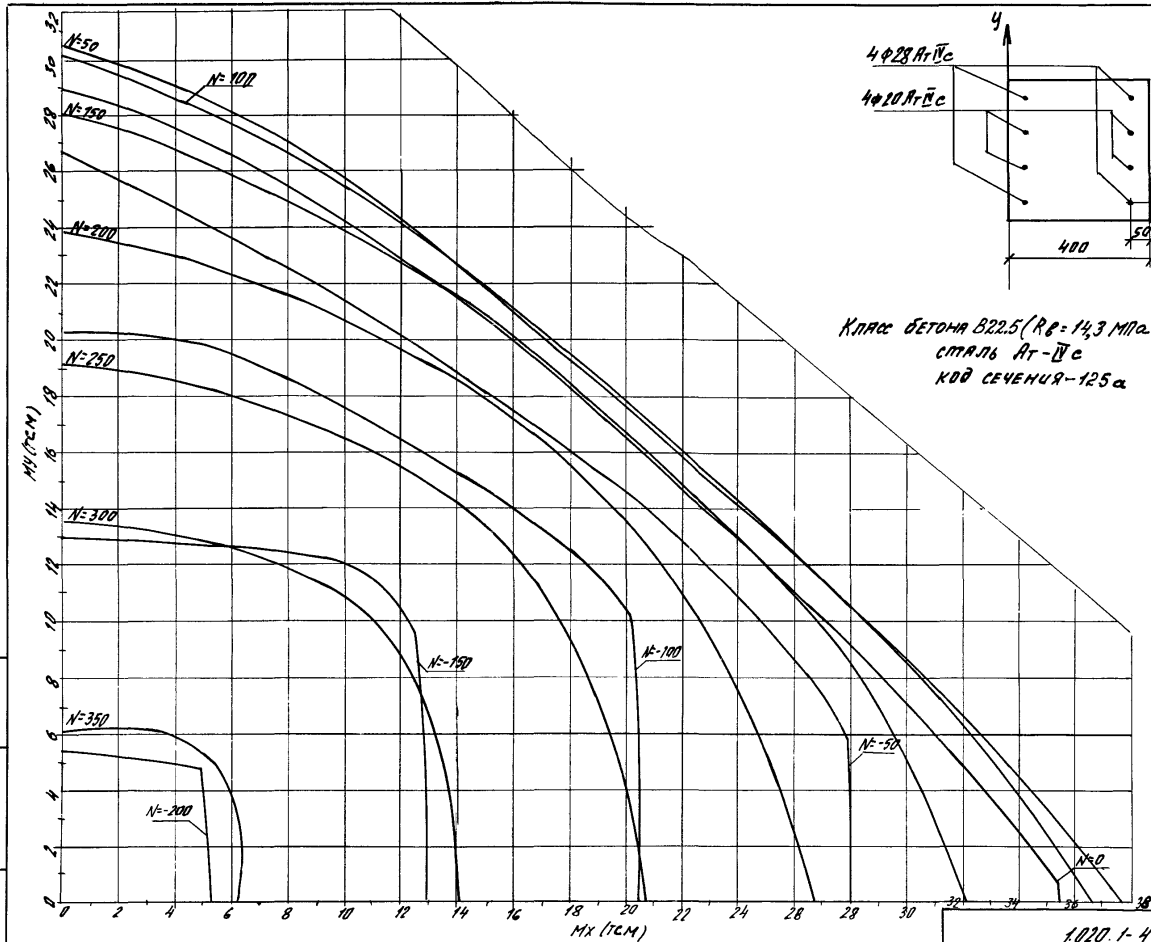

Класс бетона В22.5 ( $R_b = 14,3 \text{ МПа}$  при учете  $\gamma_{b2} = 1,10$ )  
 стержни А-I c  
 КДБ сечение 125 а

-ИТЭ ВЗДОН УИЗЭН.

1020.1-4 89 002

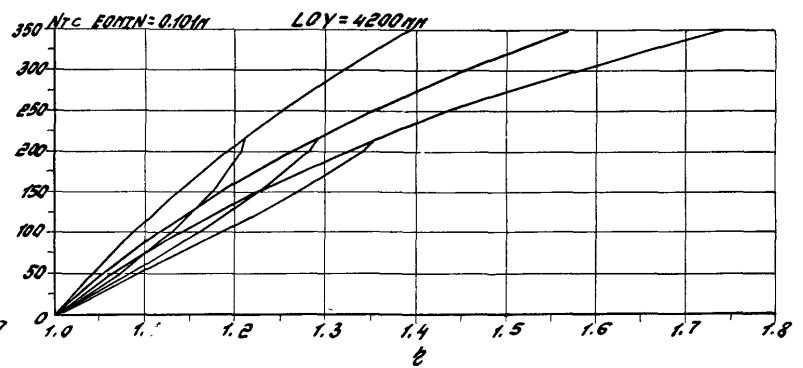
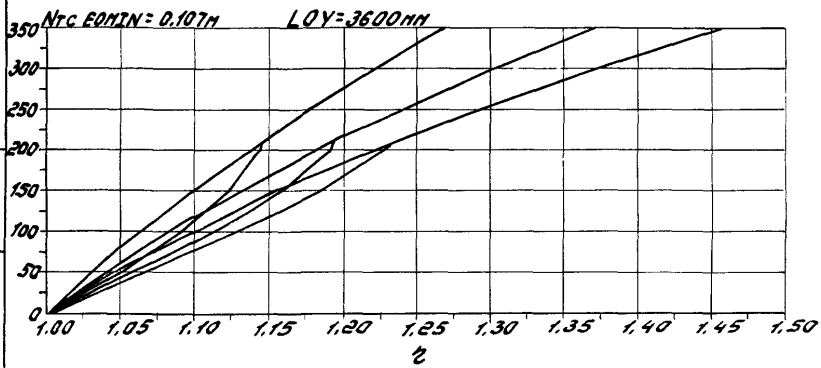
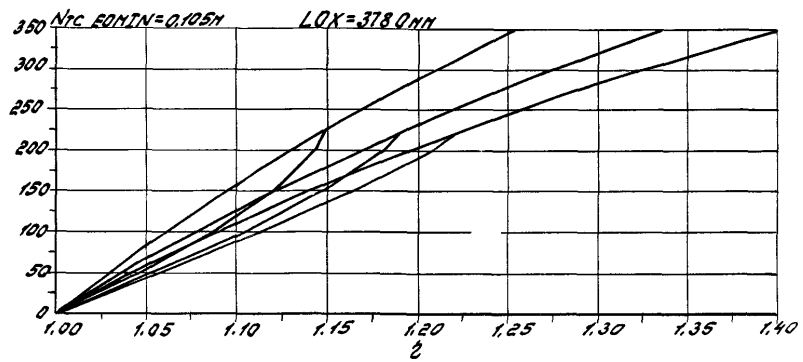
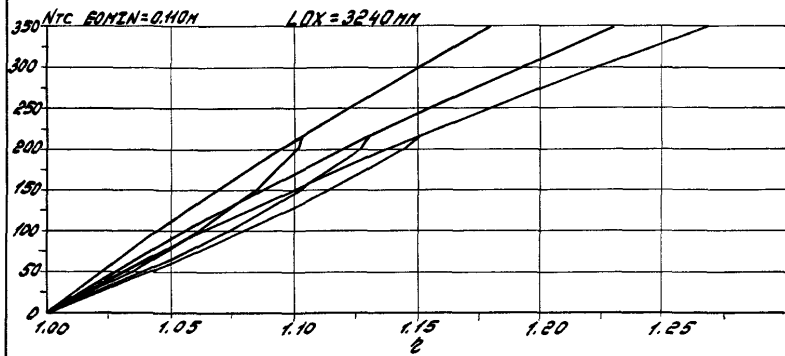

Указ. N. наезд. (Точность в 10 мм) 0,05 мм

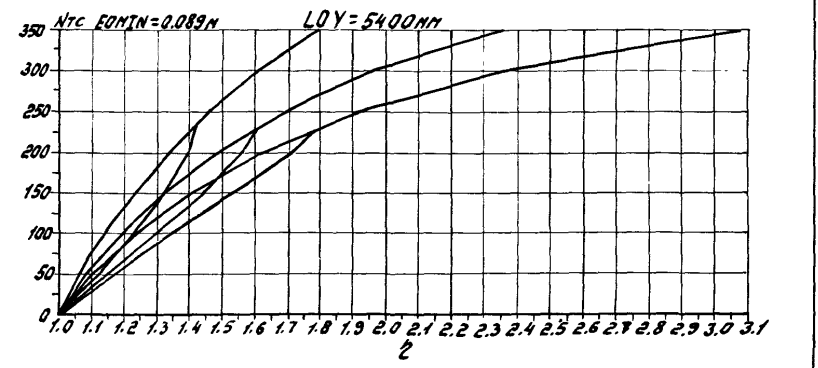
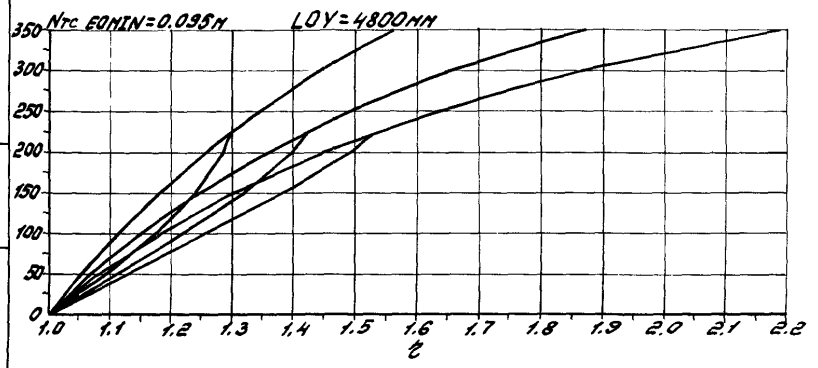
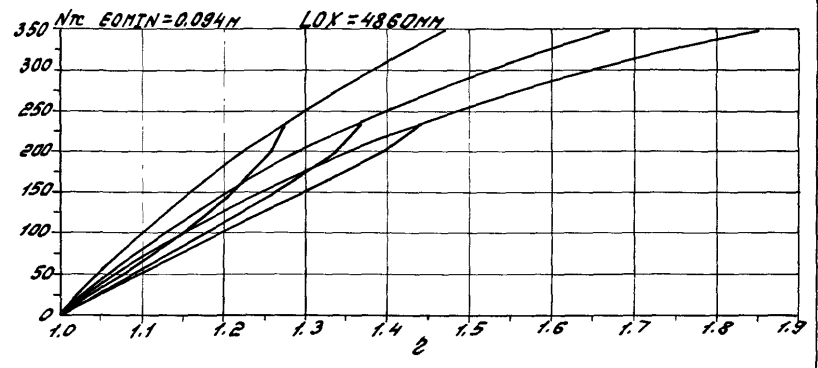
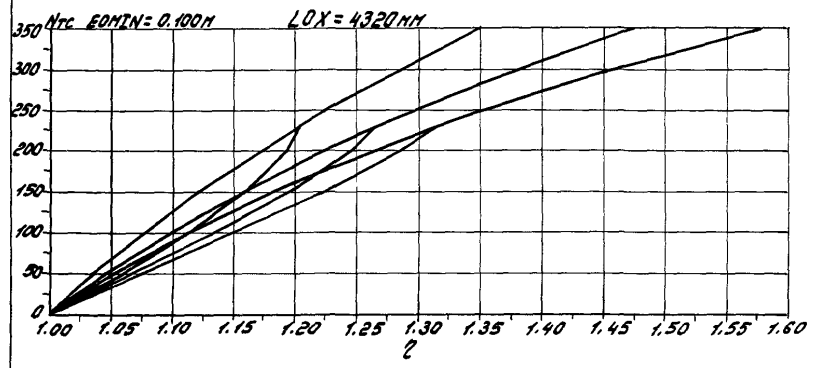

Cb U/min



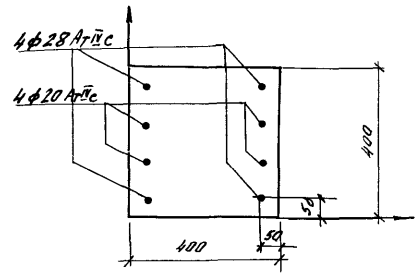
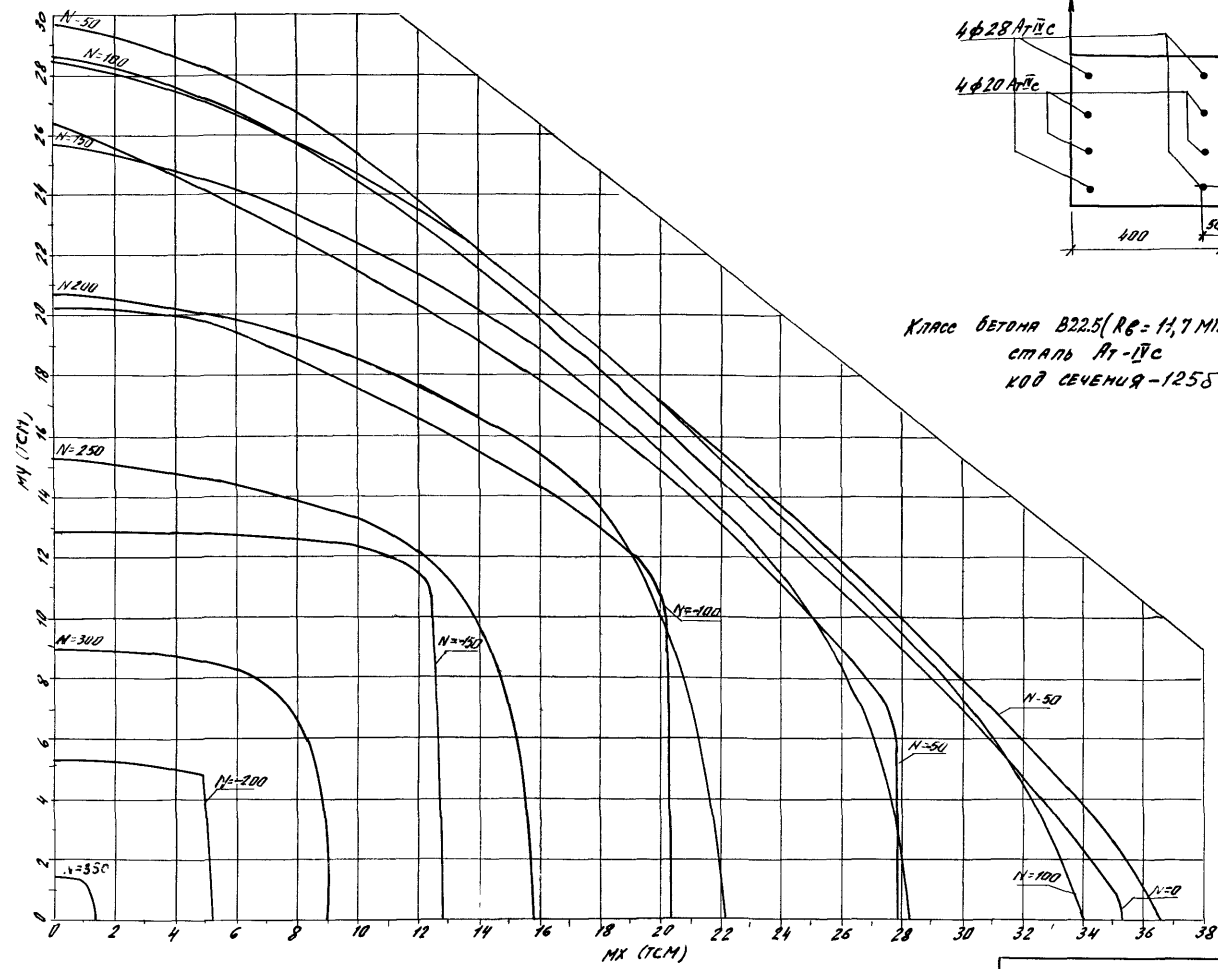

Класс бетона В22.5 ( $R_b = 11,7$  МПа при  $\gamma_{b2} = 0,90$ )  
 сталь АТ-III  
 код сечения - 1258

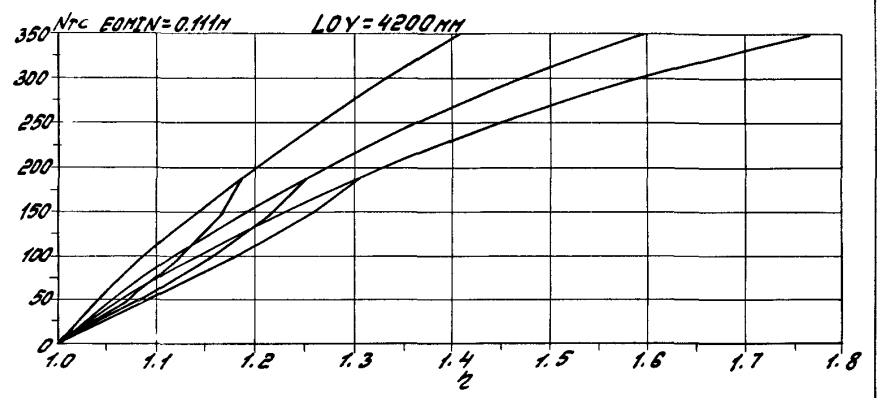
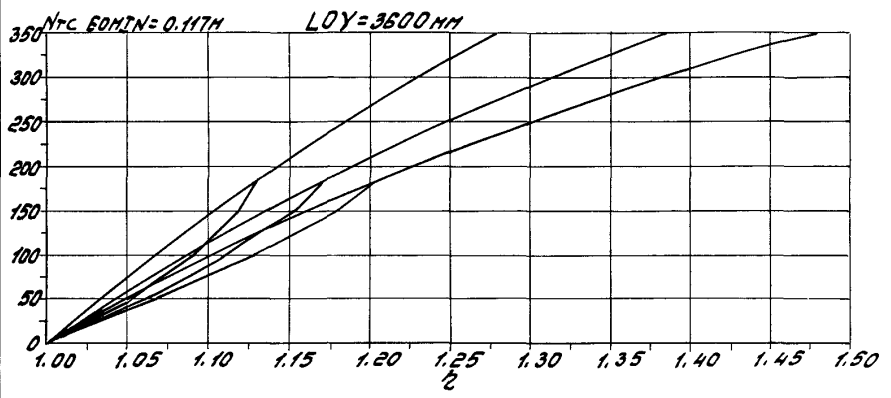
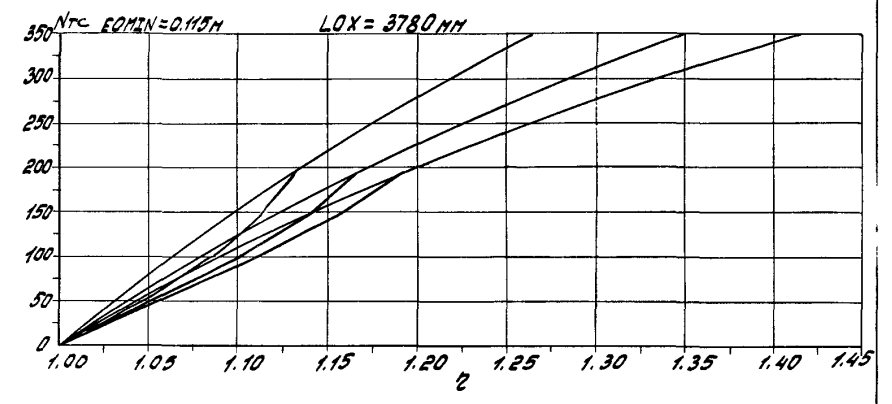
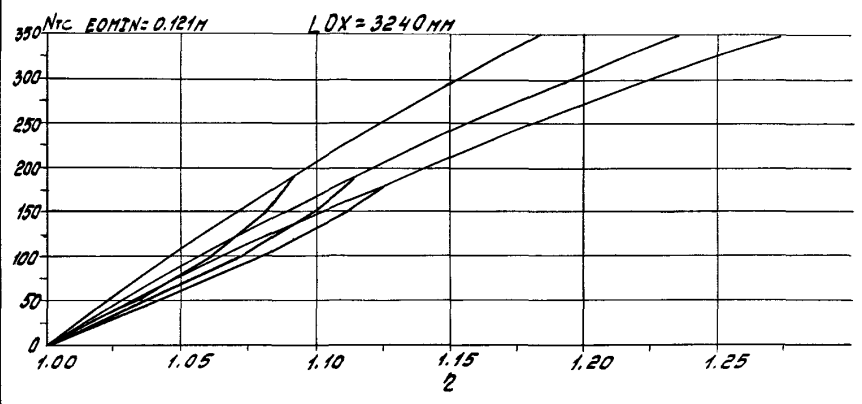

Мин. и макс. значения в точке В.С.М. (мм)

1.020. 1-4 0-9 002	198
--------------------	-----

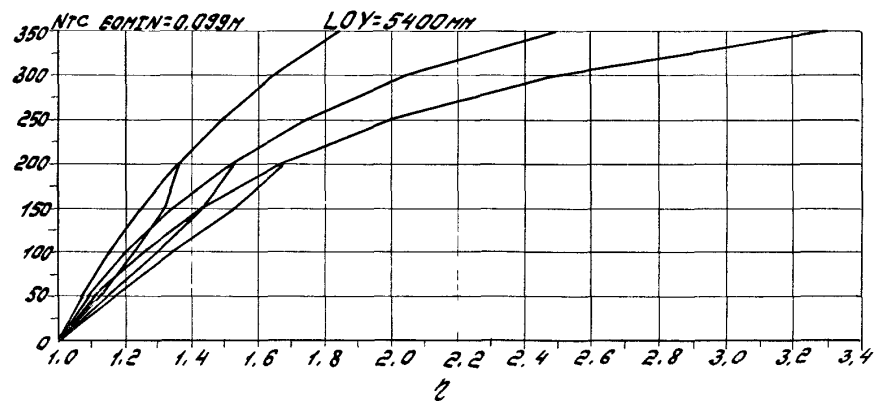
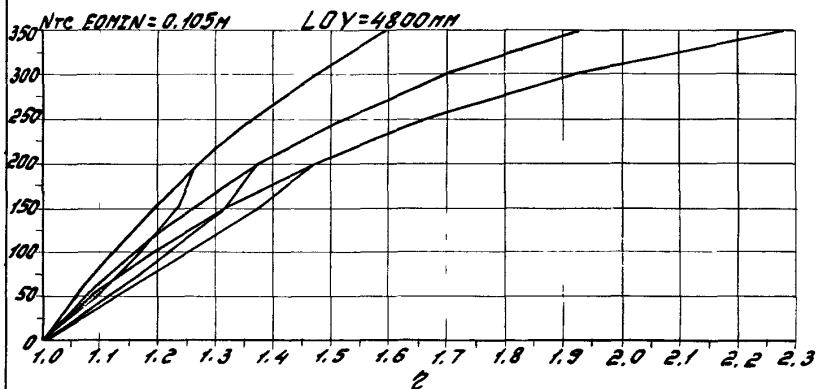
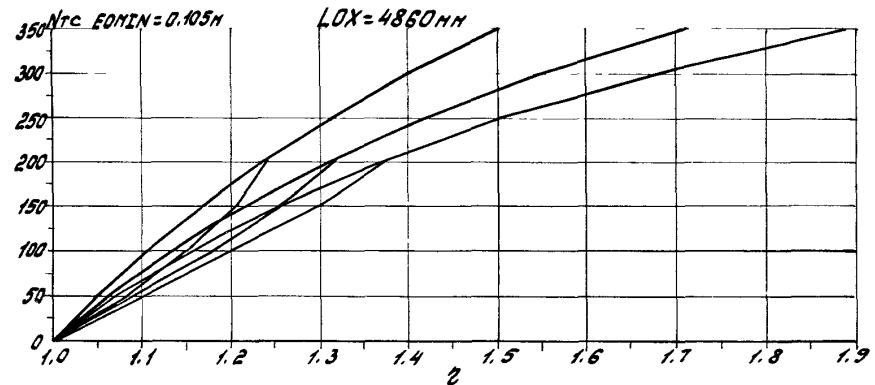
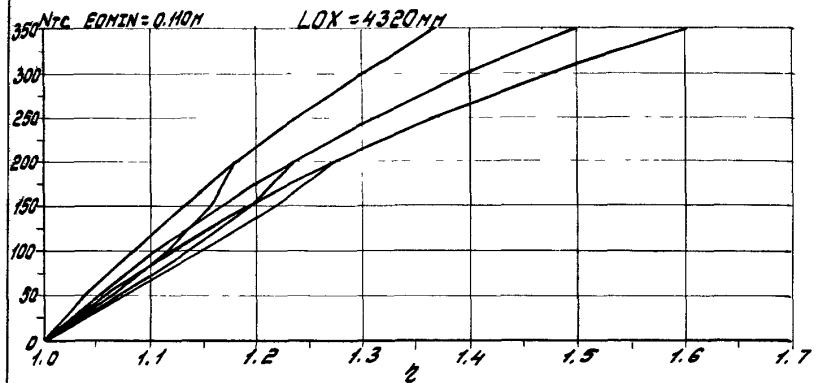

1.020.1-4 0-9 002



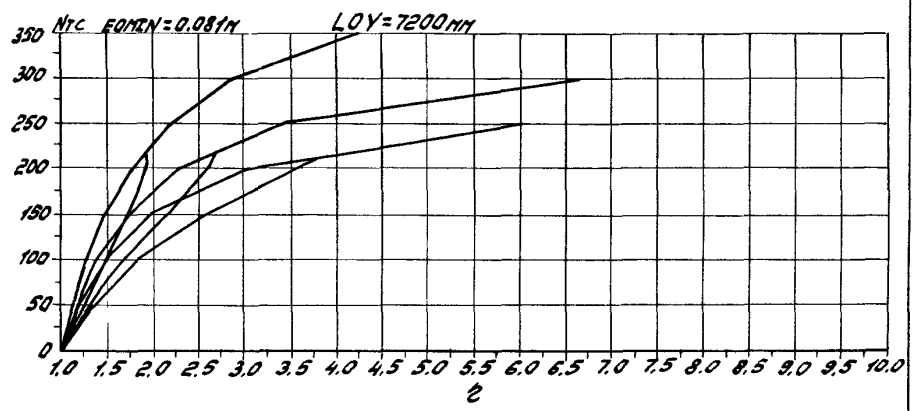
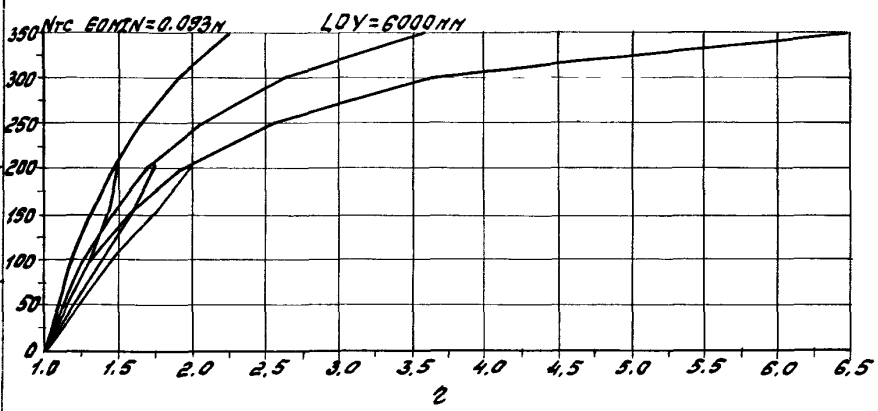
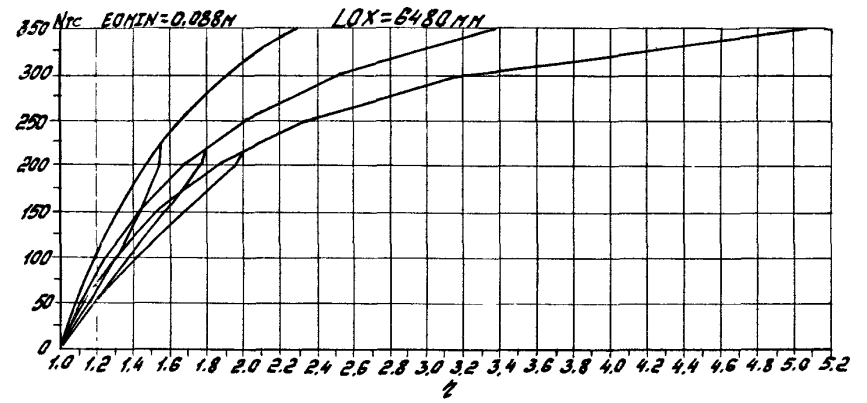
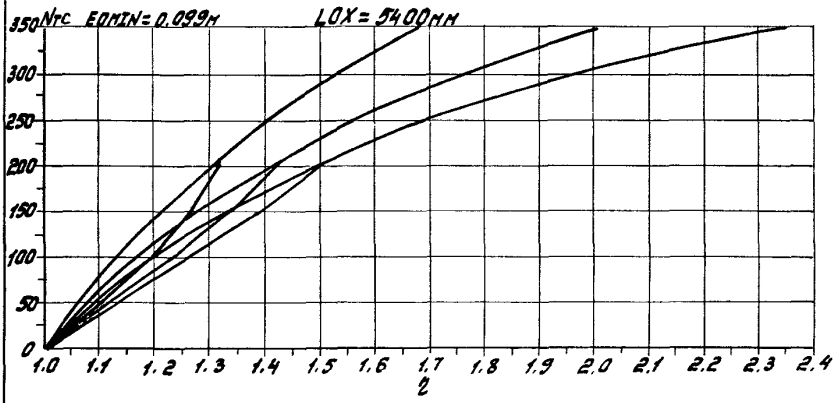

Nrc 1 град. Степень угла Beam 0.06 A

1.020.1-4 0-9 002	200
-------------------	-----

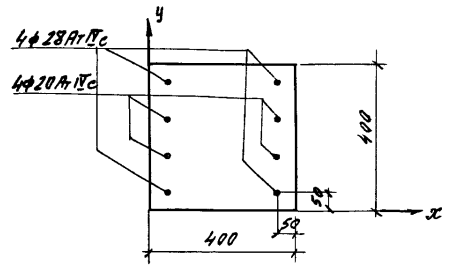
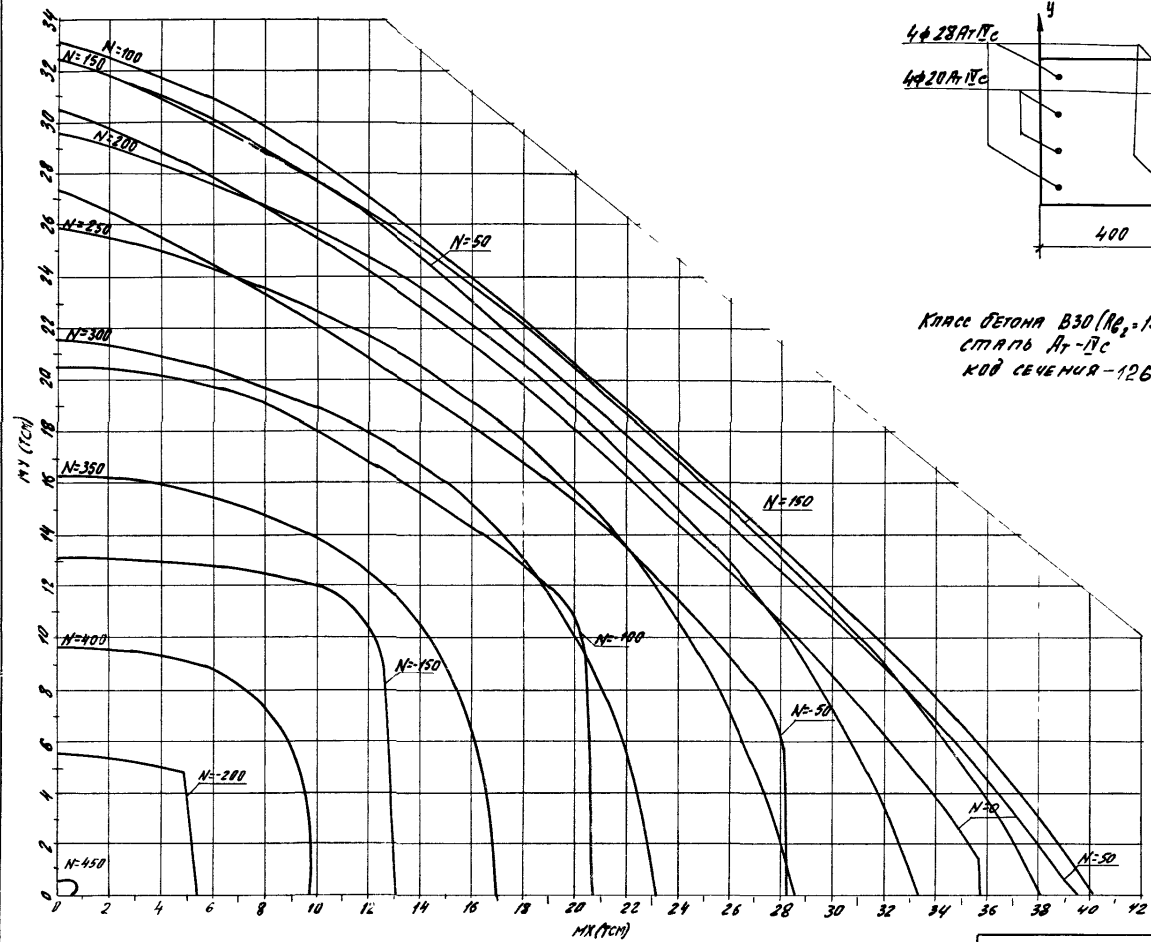

Класс бетона В30 ( $R_{b2} = 15,3$  при учете  $\gamma_{b2} = 1,1$ )  
 сталь А-I  
 код сечения - 126a

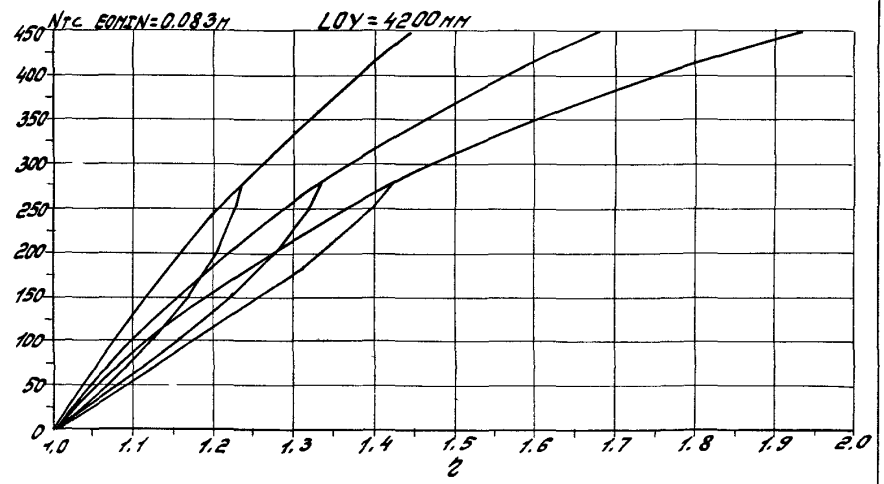
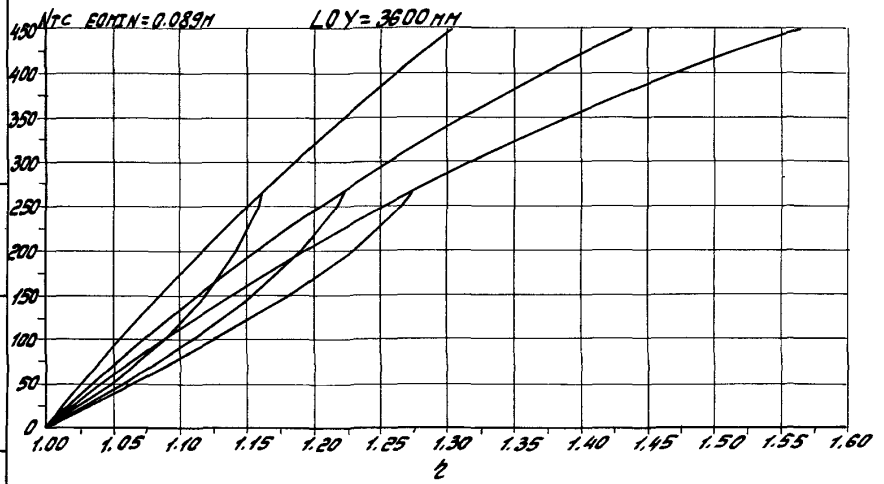
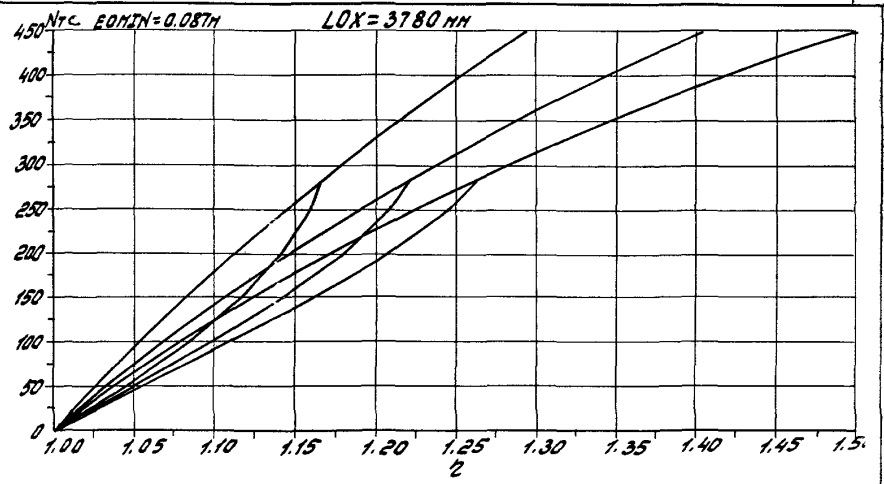
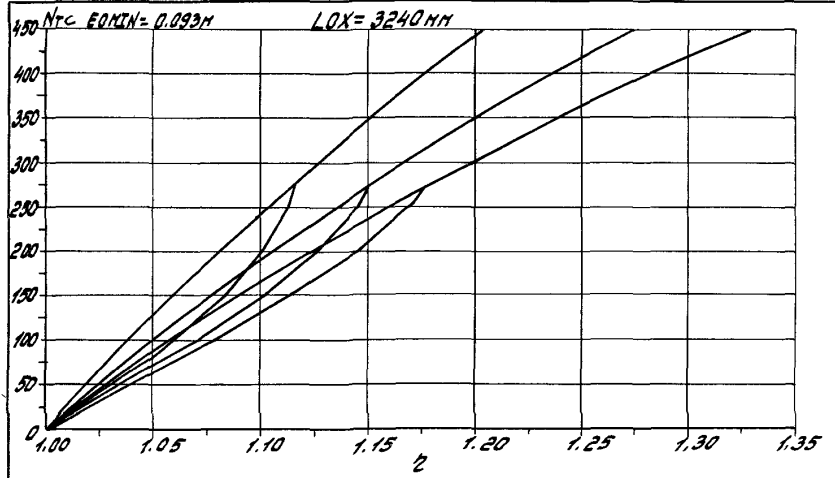

УГОДАНИЕ ВУЗОВ И ДОМА ВЗРОСЛЫХ

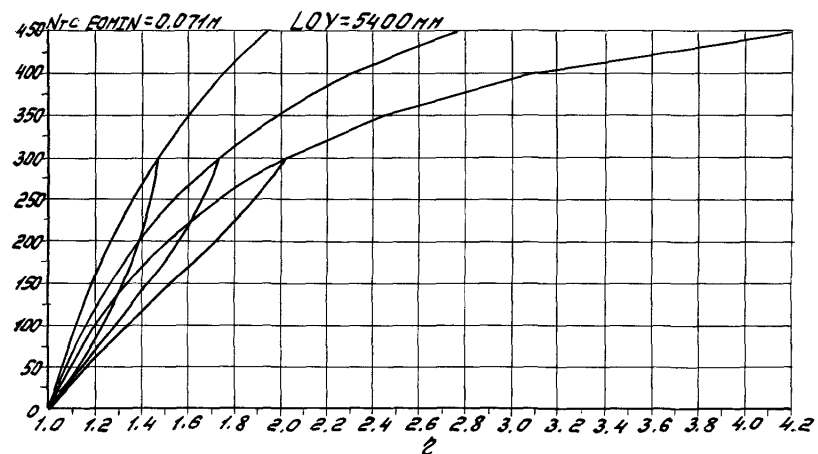
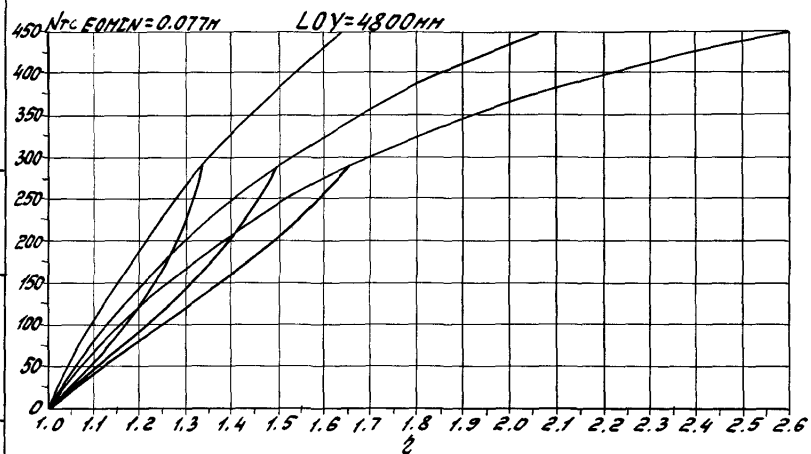
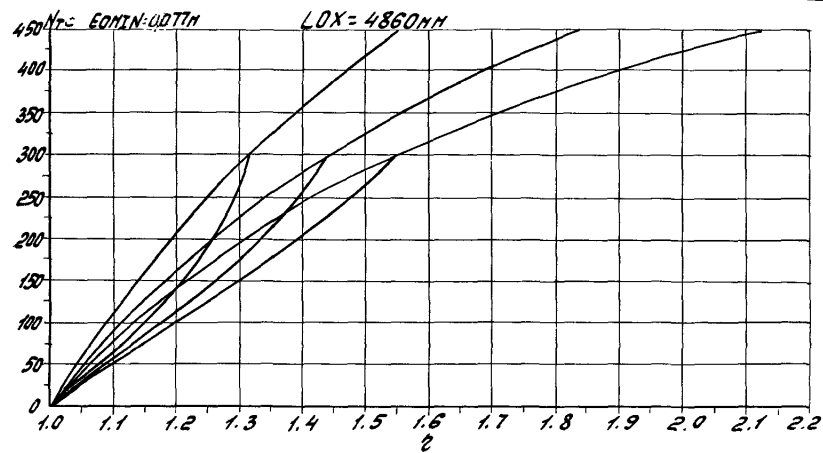
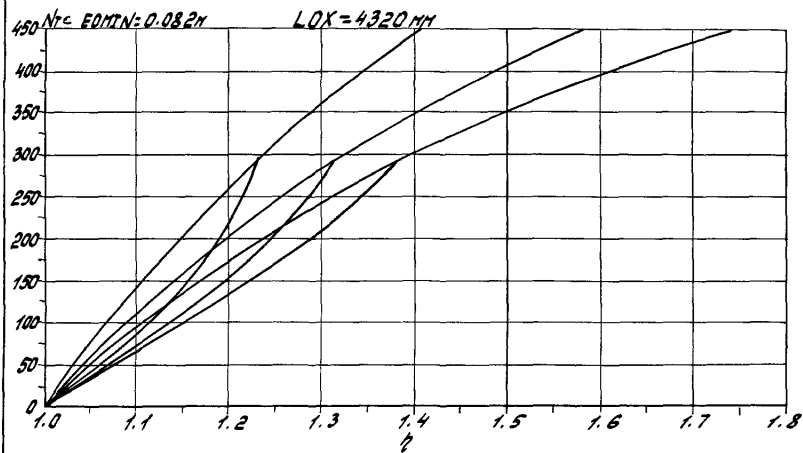

1.020.1-4 0-9 002

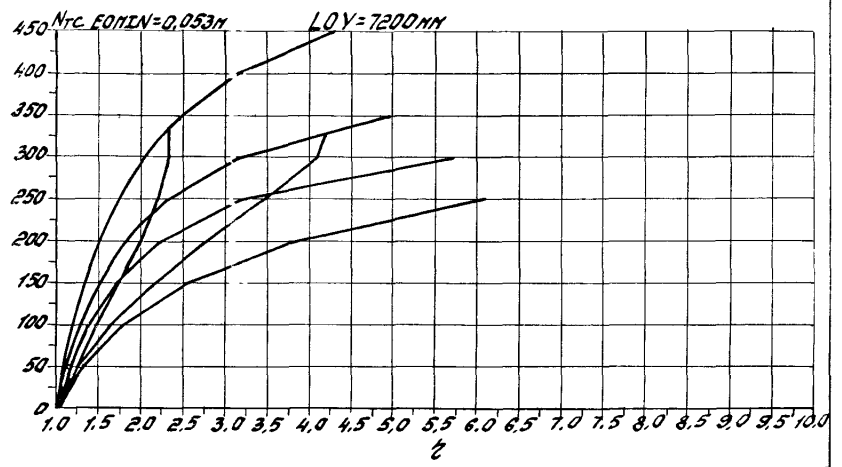
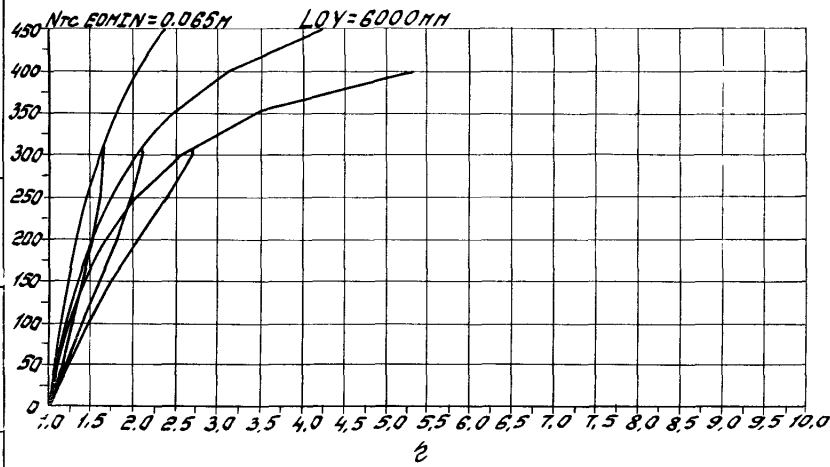
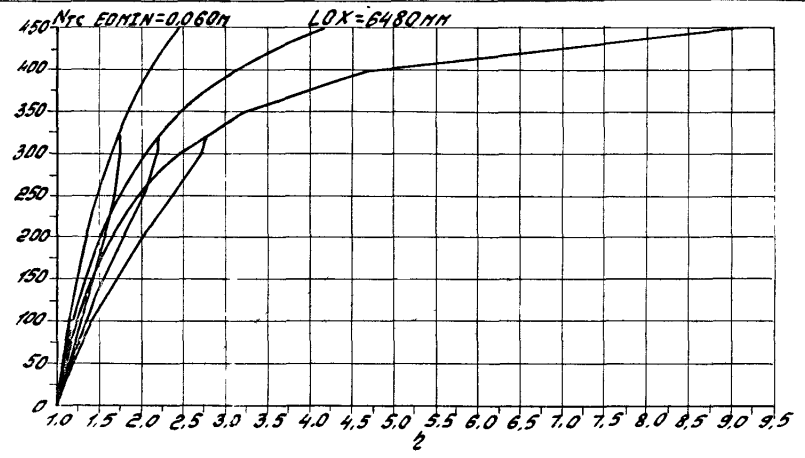
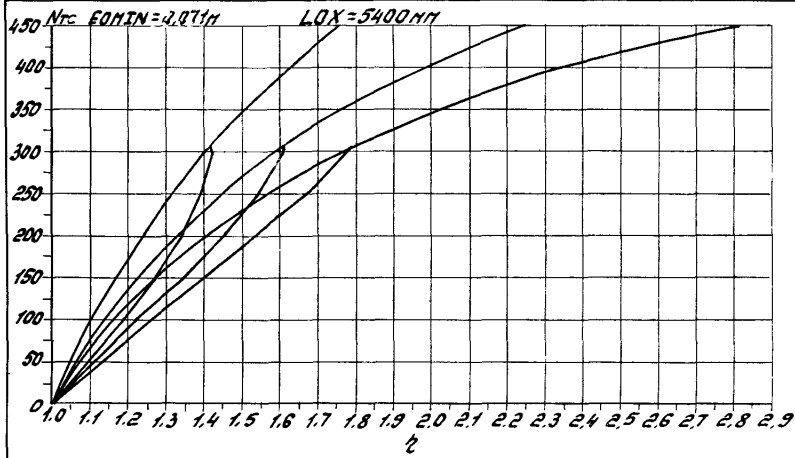

Упр. и граф. работы у д.т.н. Л.З.И.И.И.И.И.

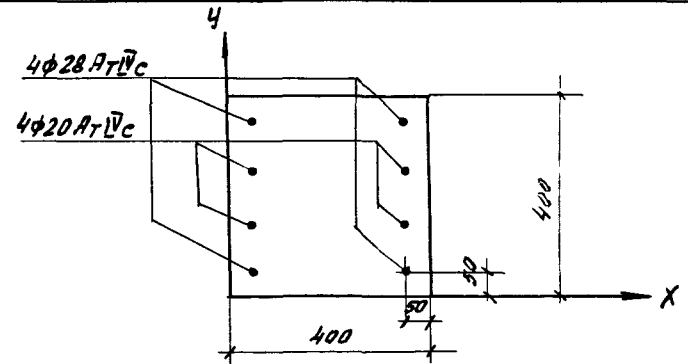
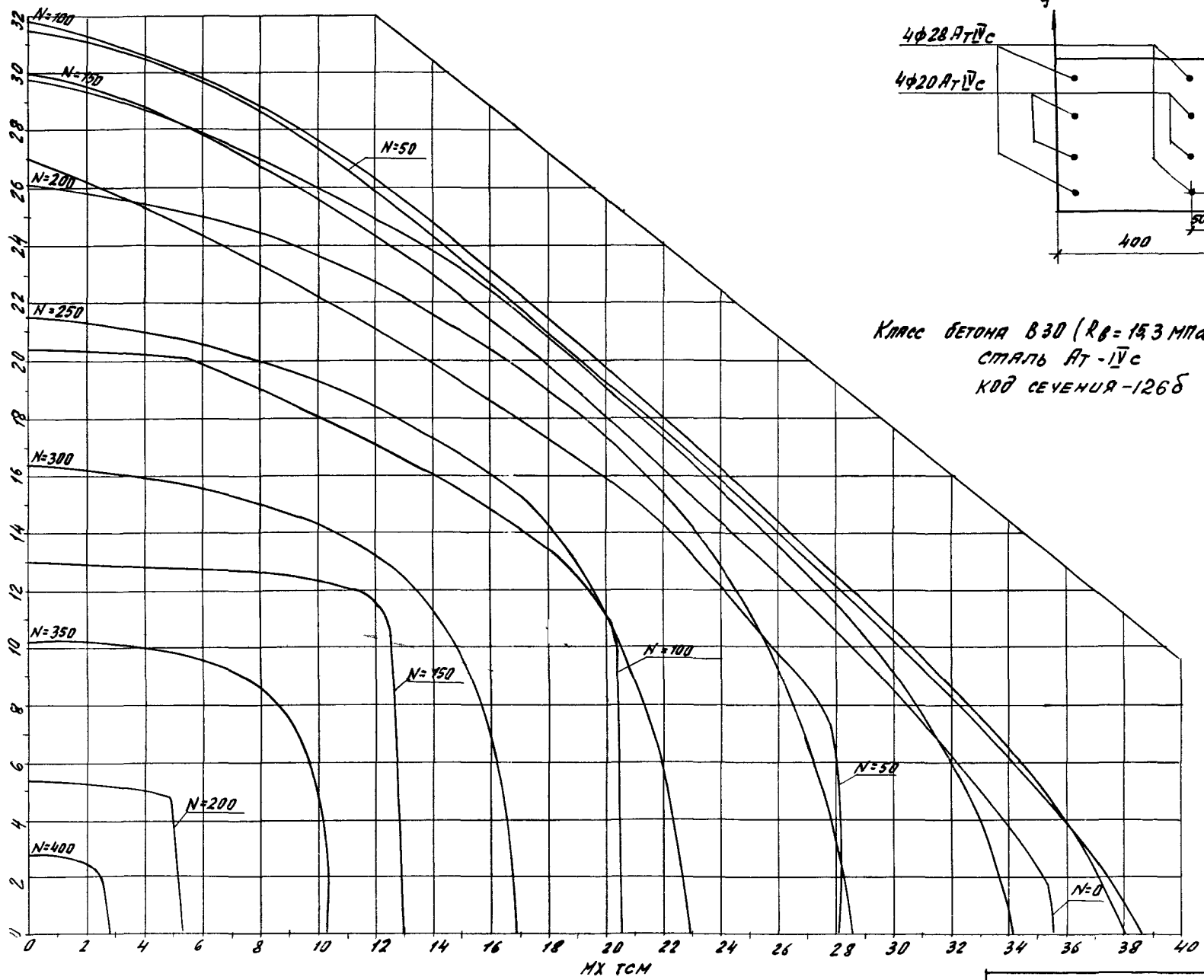

Класс бетона В30 ( $R_b = 15.3 \text{ МПа}$  при учете  $\gamma_{c2} = 0.90$ )  
 Сталь АТ-IVc  
 Код сечения - 126б



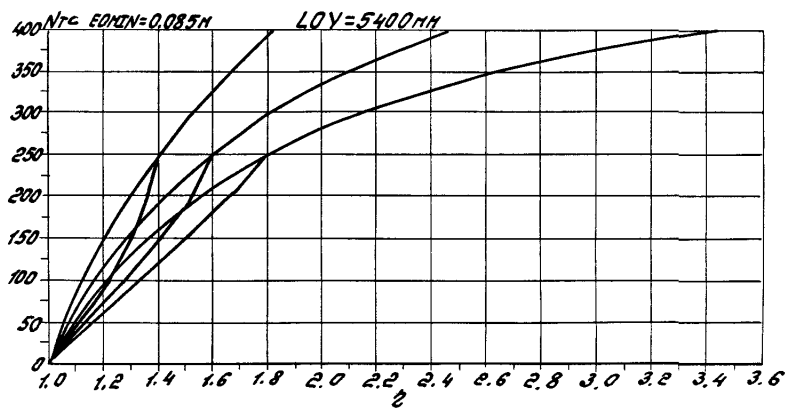
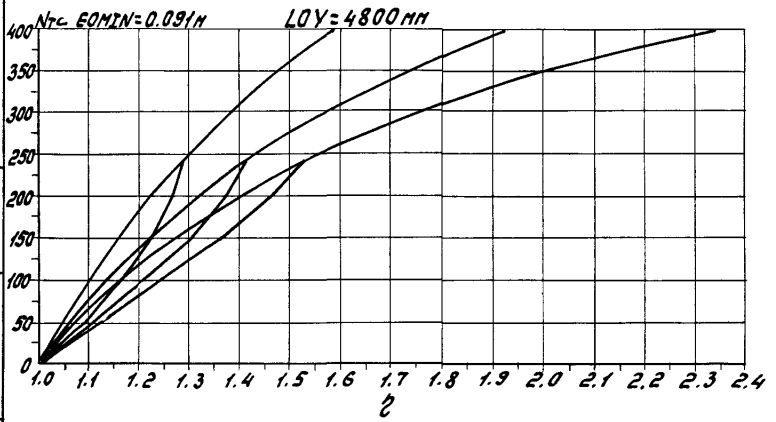
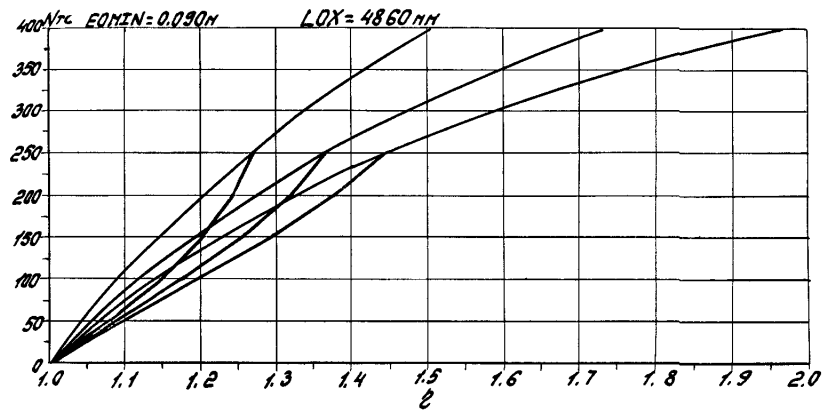
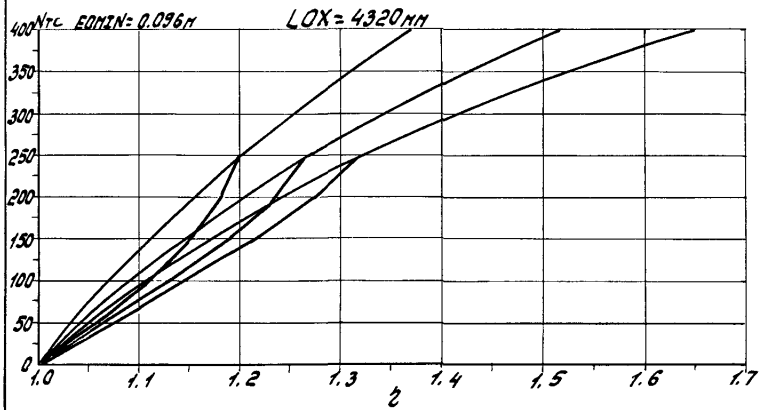



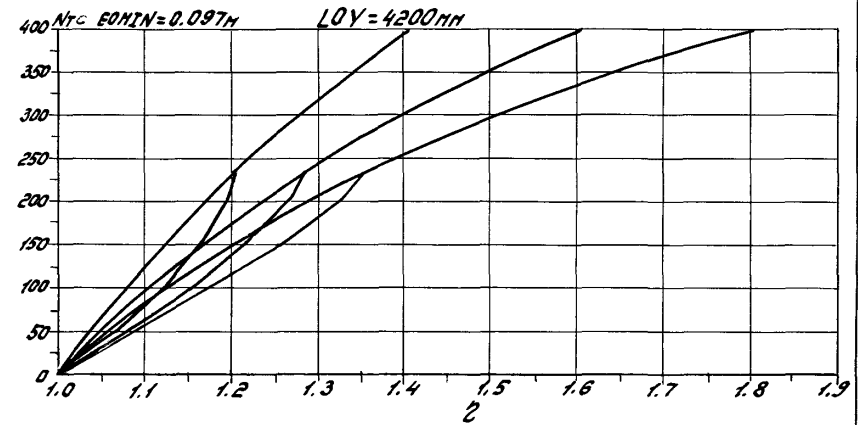
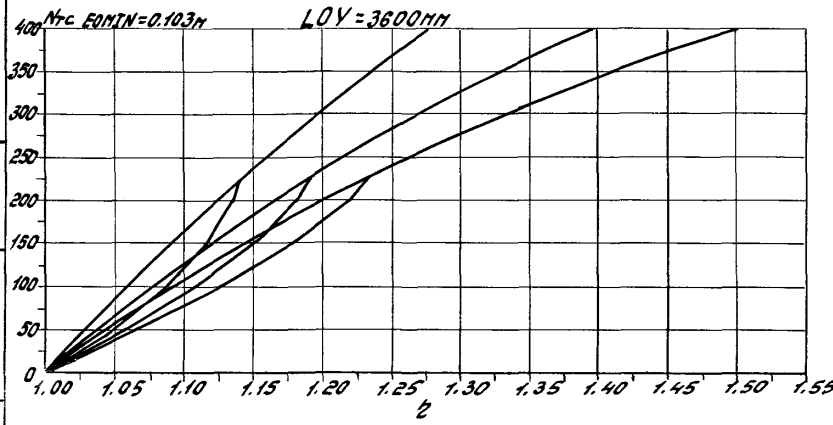
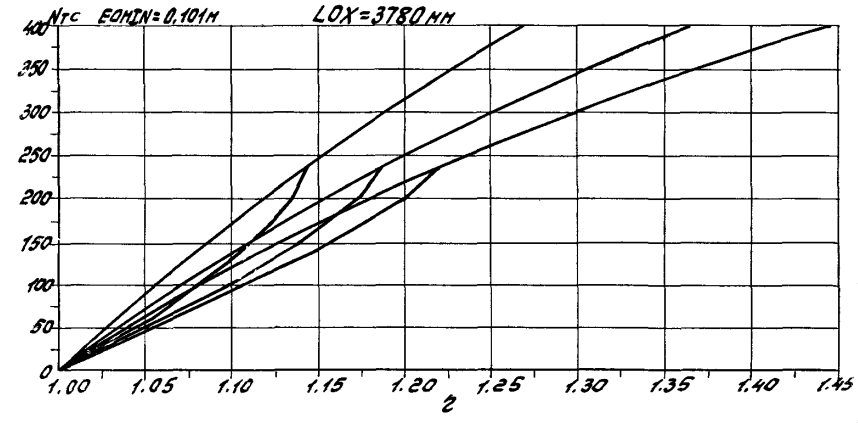
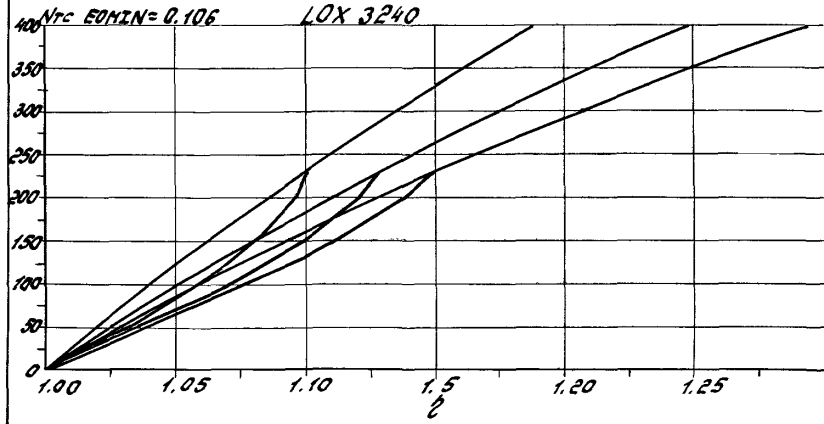

№ 8. Итого. Продукты с диаметром 100 мм.

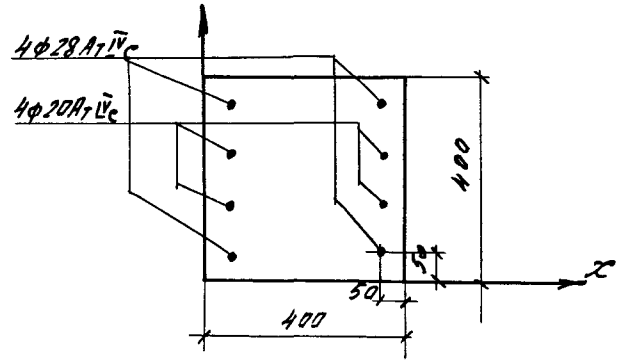
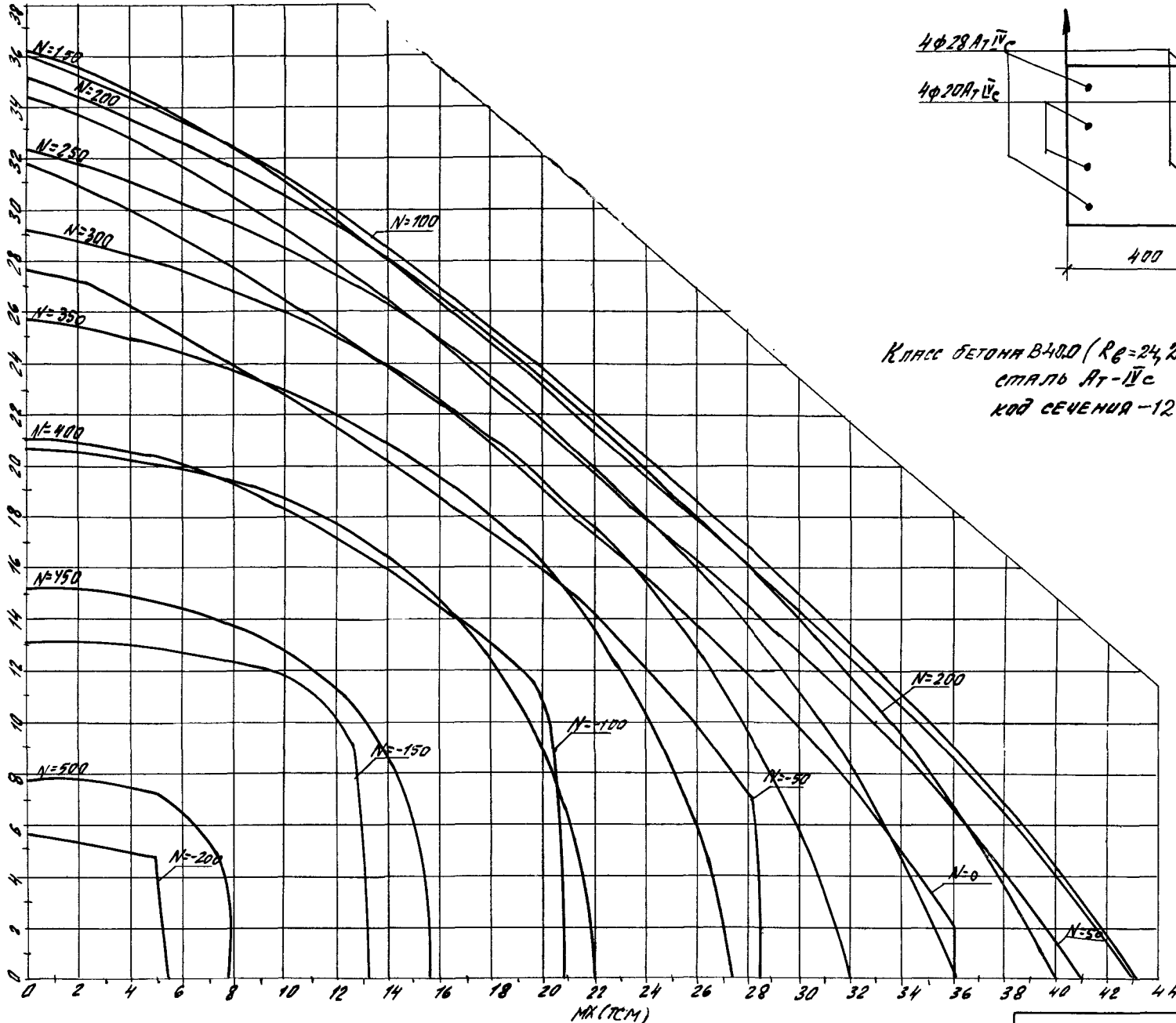

КЛАСС БЕТОНА В40.0 ( $R_b = 24,2$  МПа при учете  $\gamma_{b2} = 1,10$ )  
 СТАЛЬ А1-IVc  
 КОД СЕЧЕНИЯ -127u

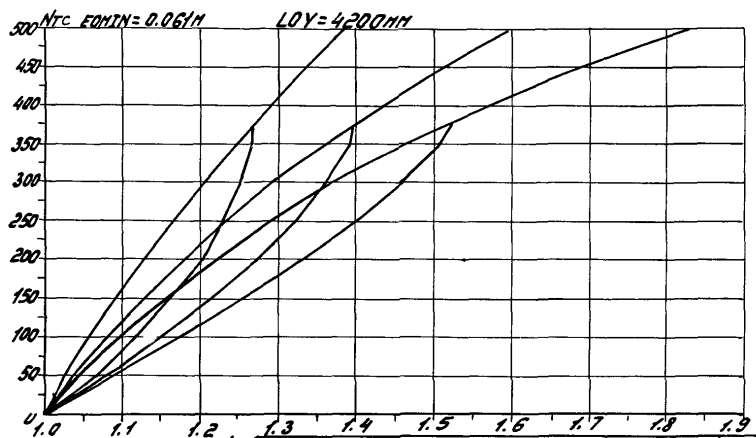
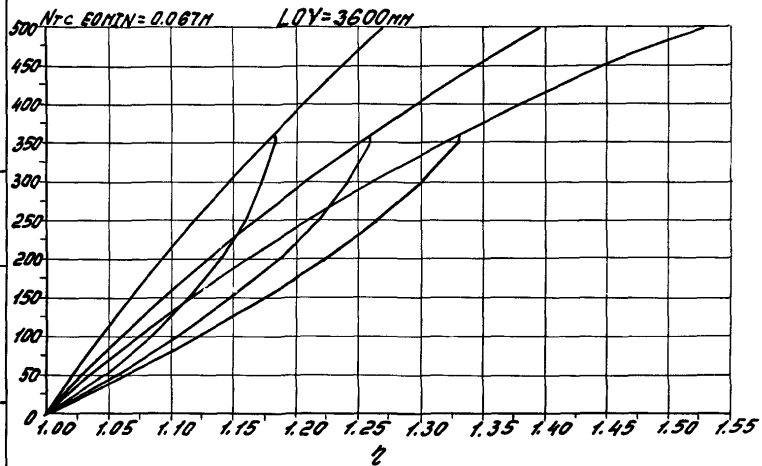
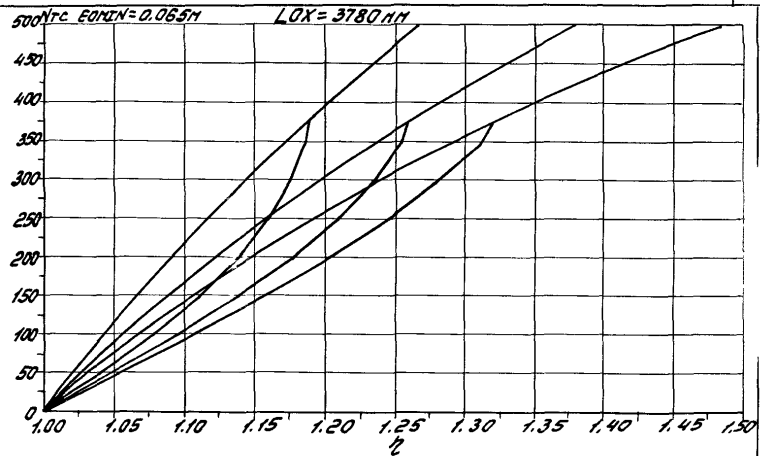
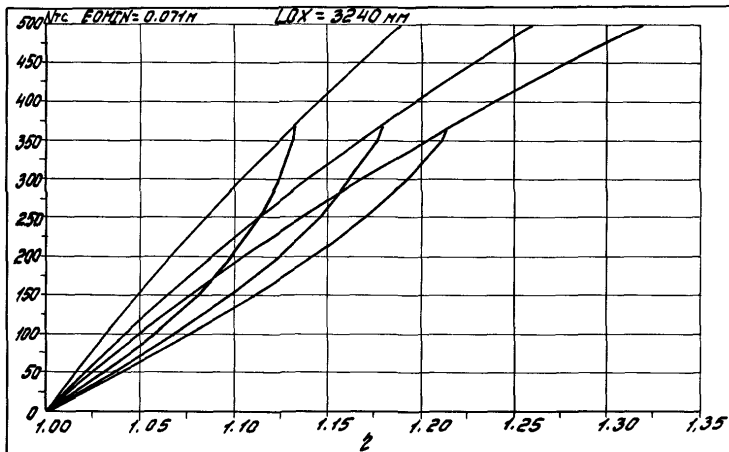

1.0201-4 0-9 102

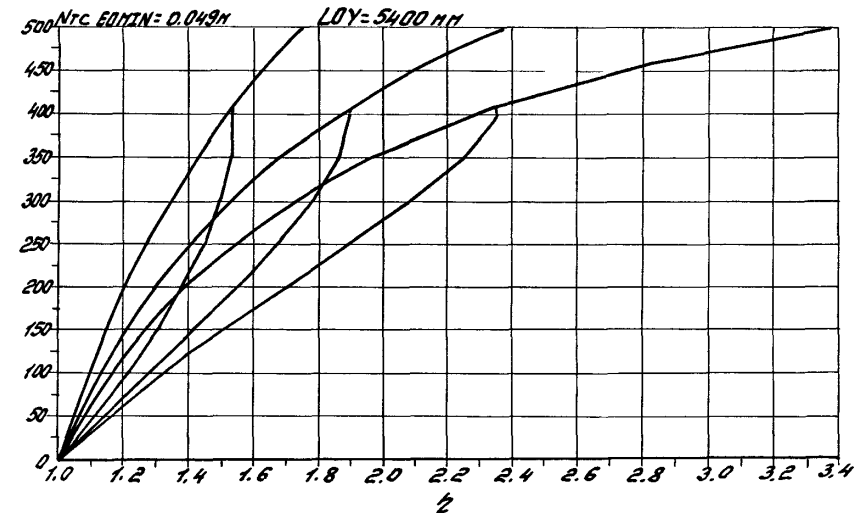
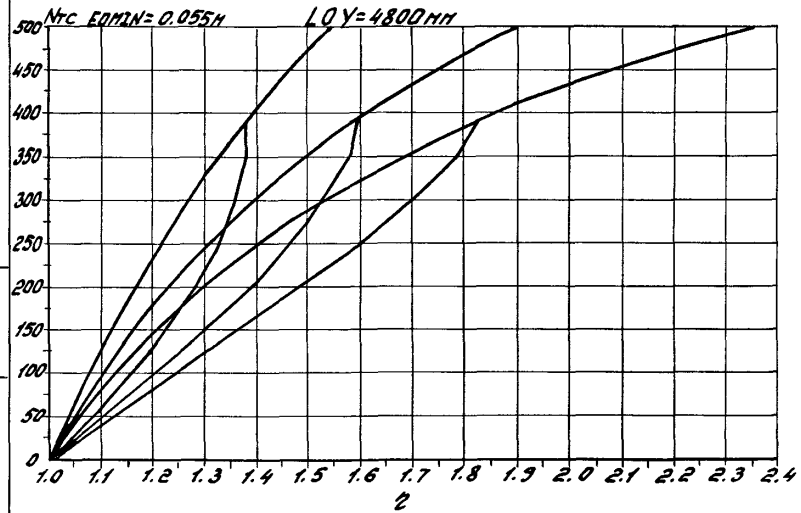
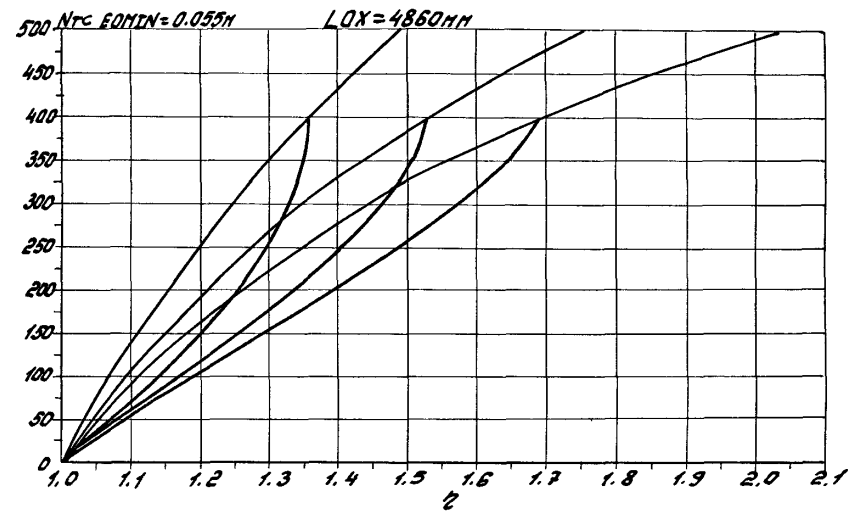
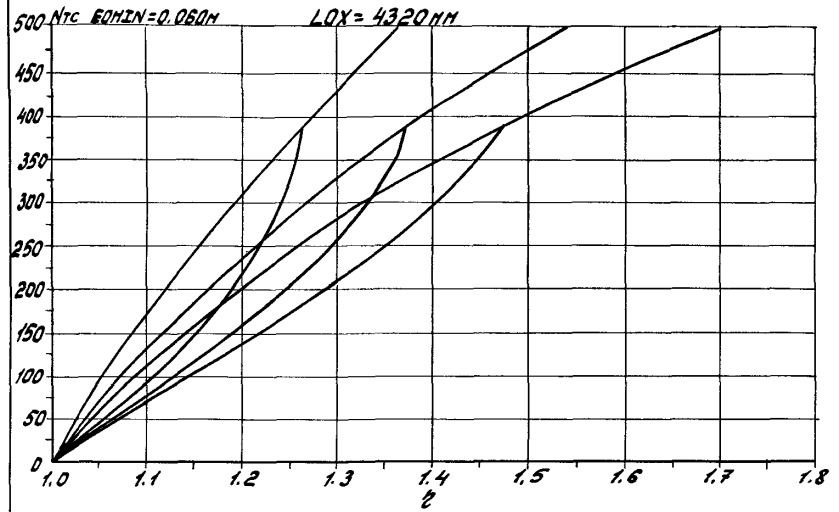

Угол наклона. Высота и длина борта

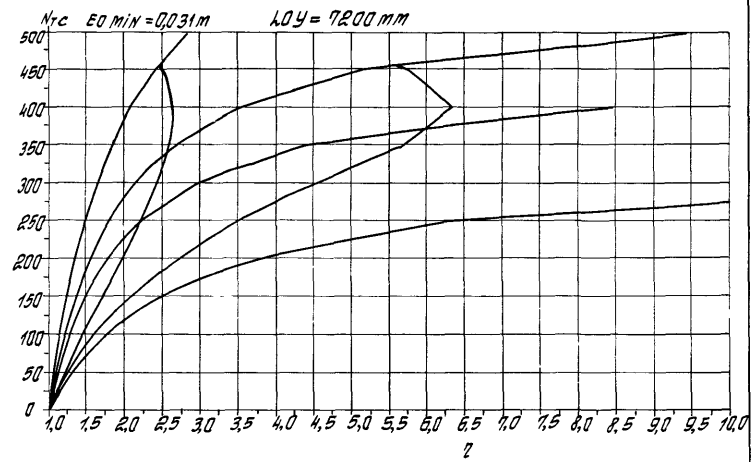
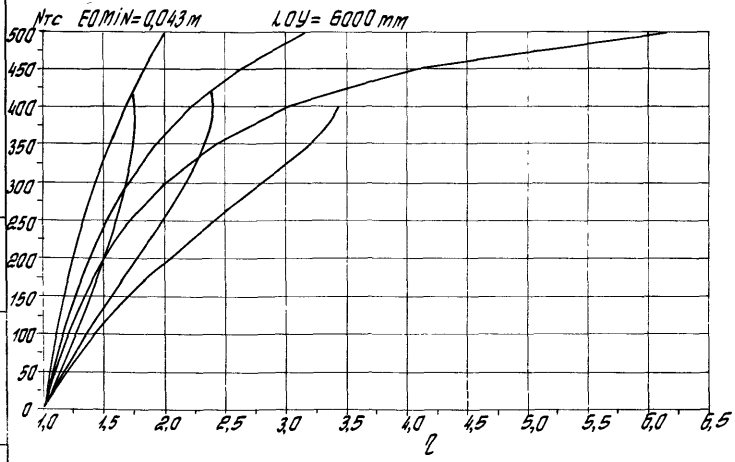
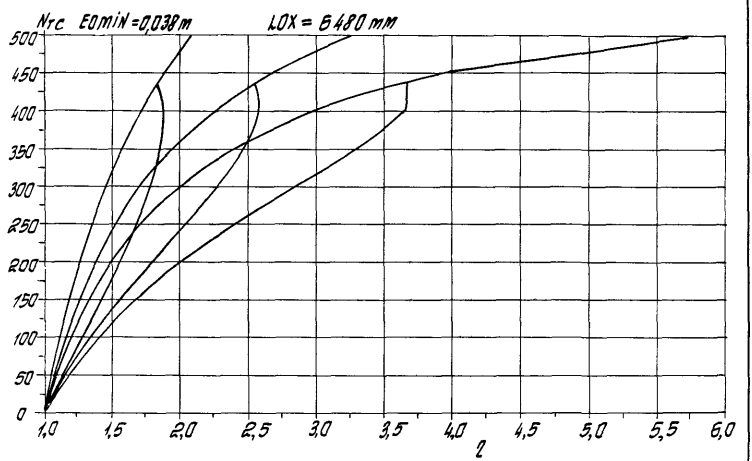
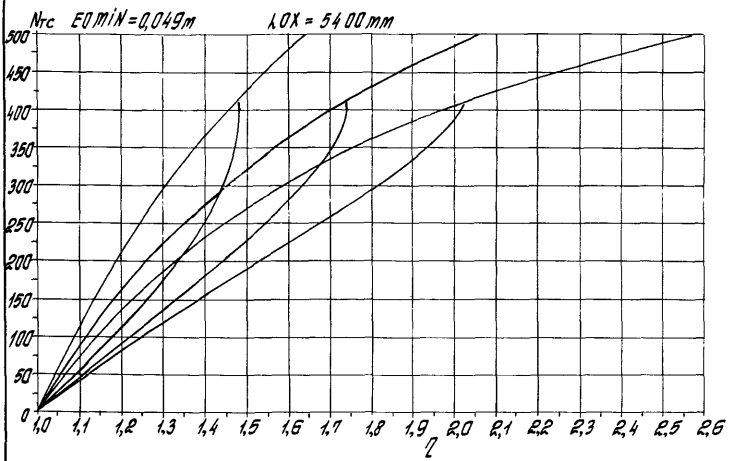

Лист № 1000. Инвентарный № 1. Дата: 08.09.2010 г.



УИГБ. N110021. Подписи в журнале. 03.01.1962. N

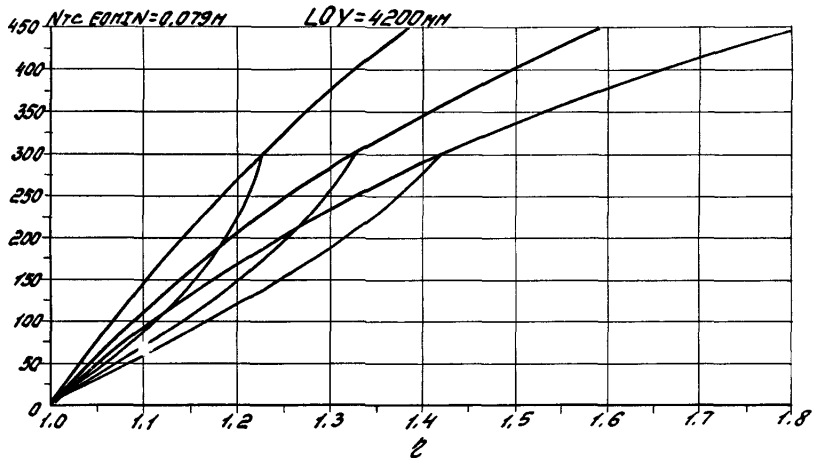
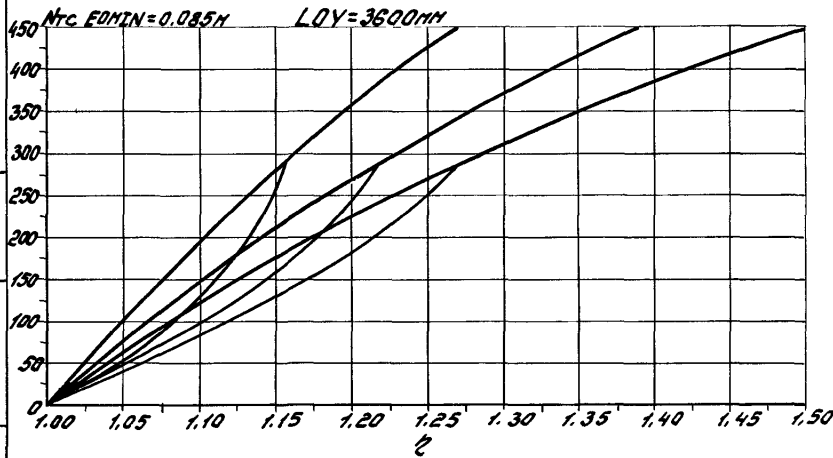
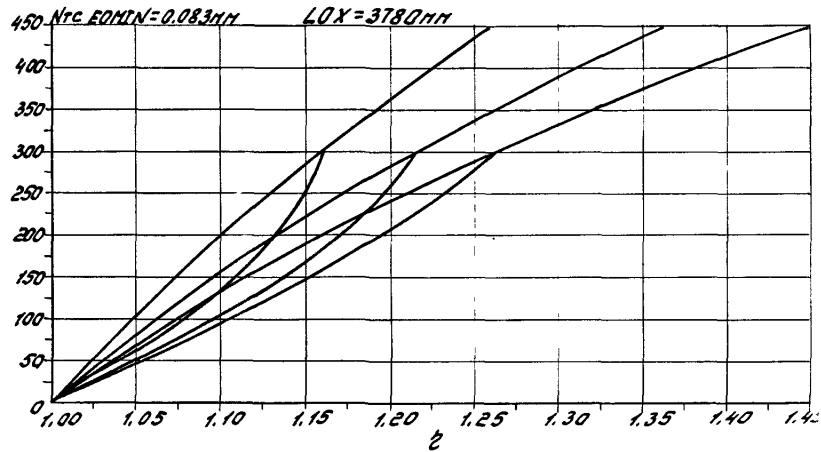
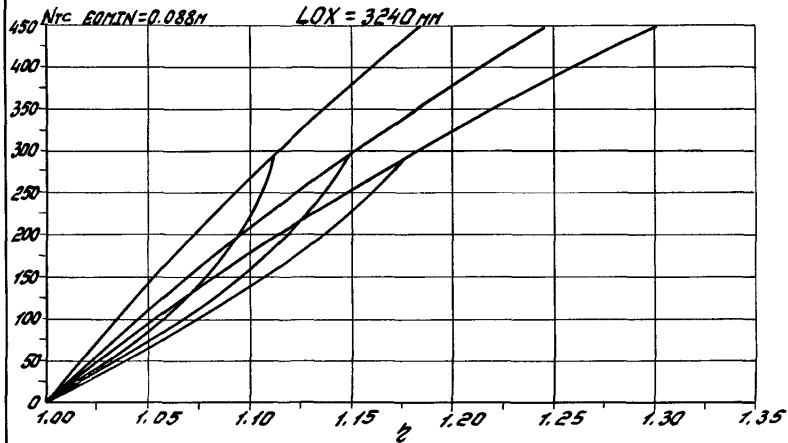

1.020.1-4 0-9 002

1/100  
214

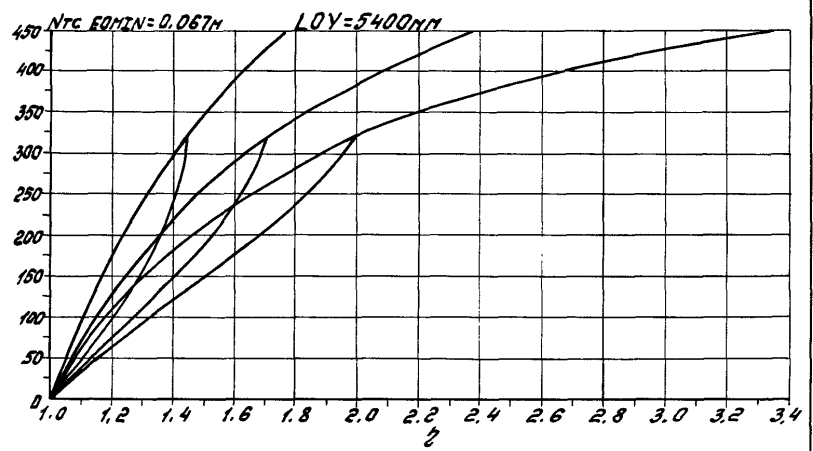
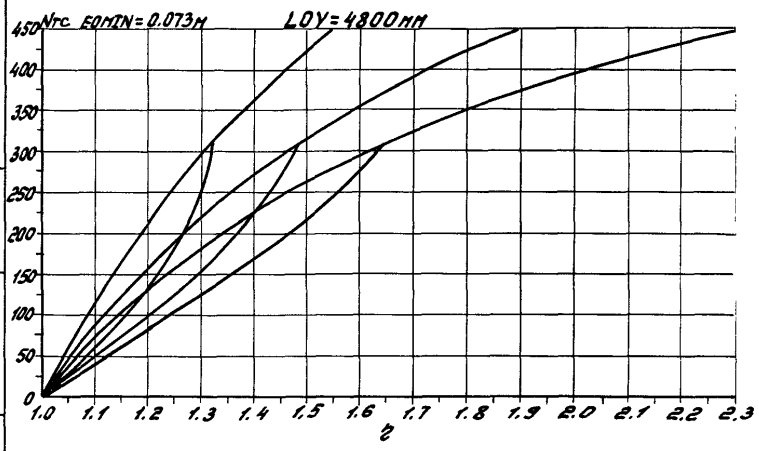
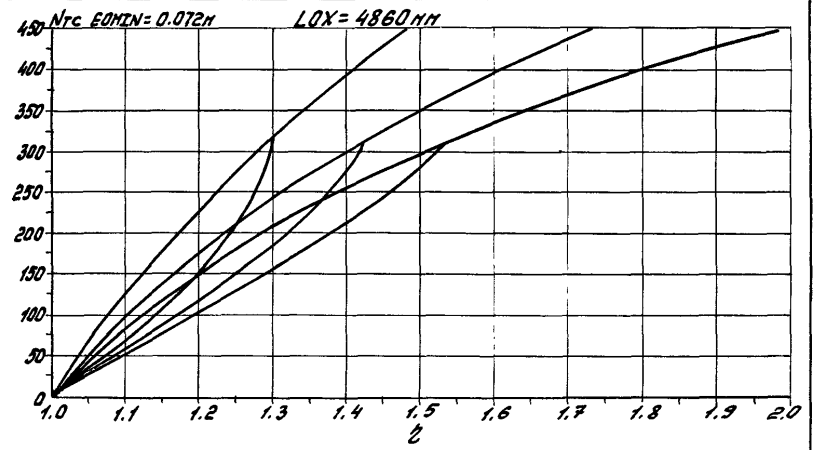
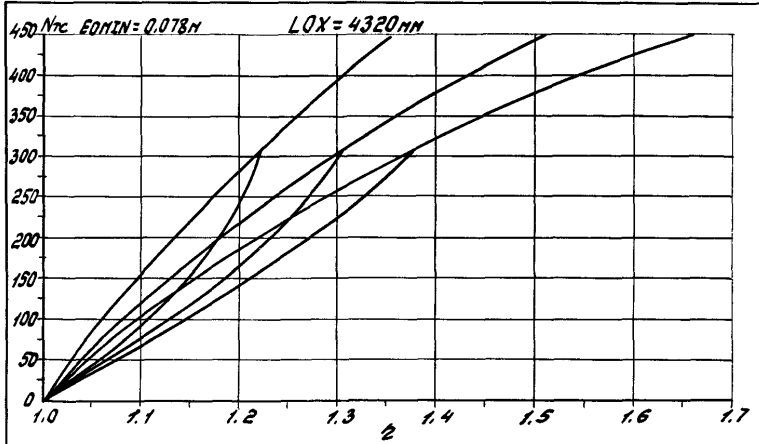

NTC EQMIN



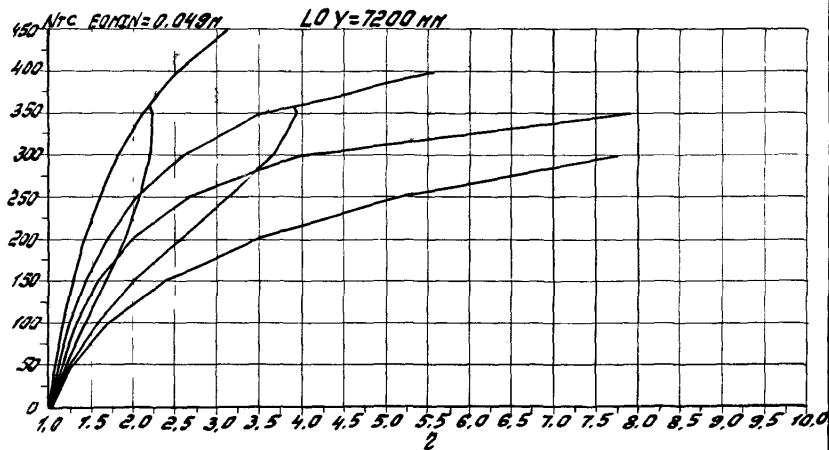
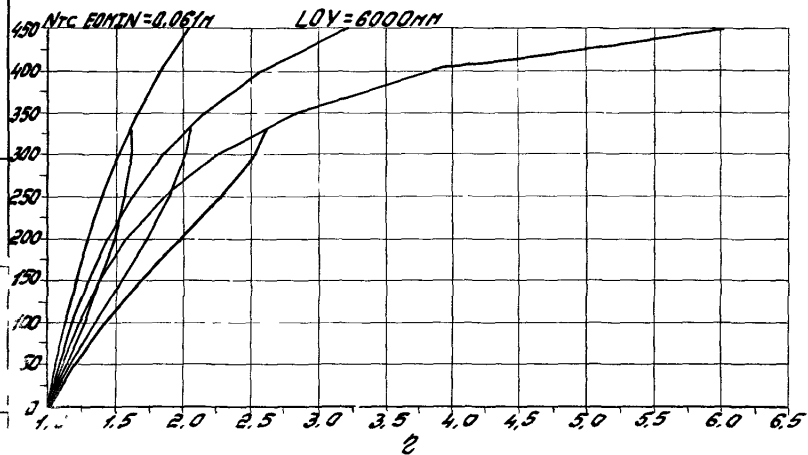
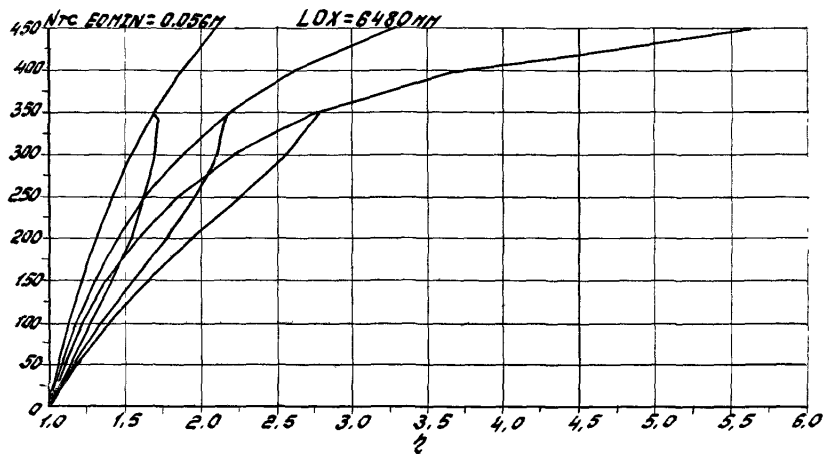
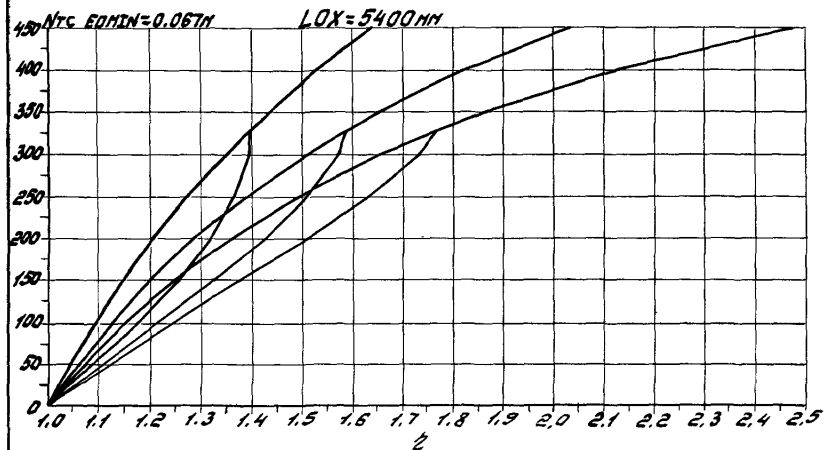

1/18 N (mm) Podpis v 2012 B. 2012. 2012.

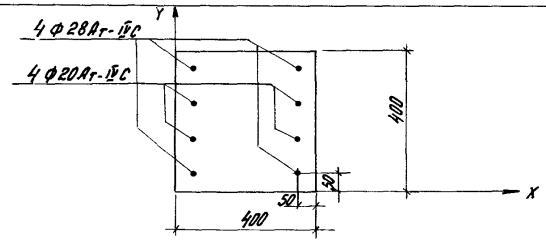
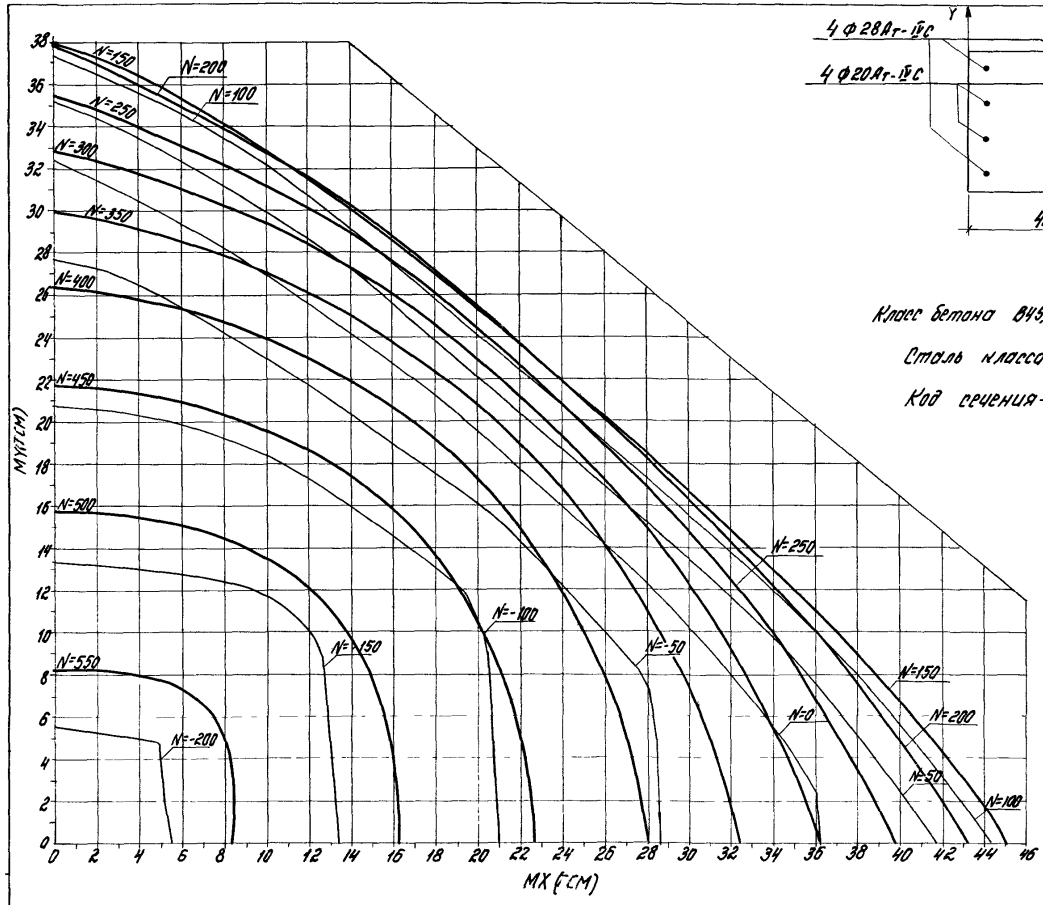

Класс бетона В45,0 ( $R_R = 27,5$  МПа при учете  $\gamma_{R2} = 1,10$ )  
 Сталь класса Аγ-IV С  
 Код сечения-128а

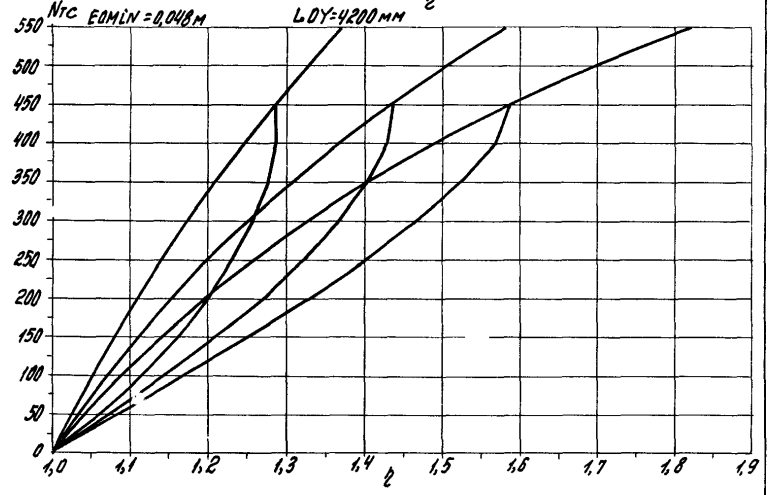
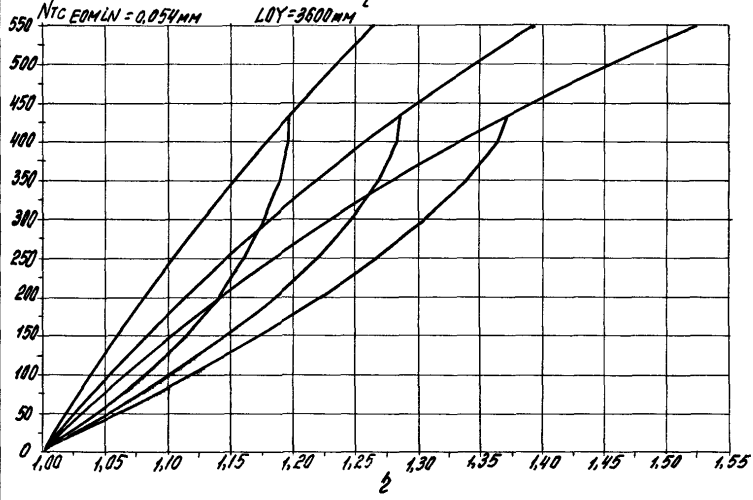
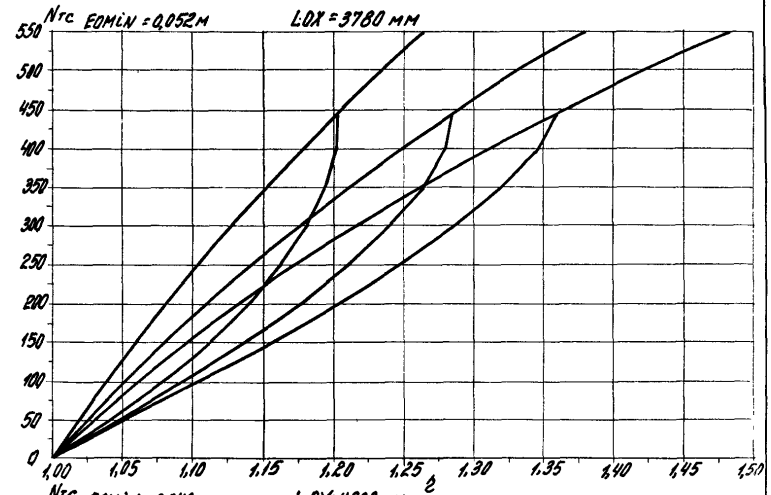
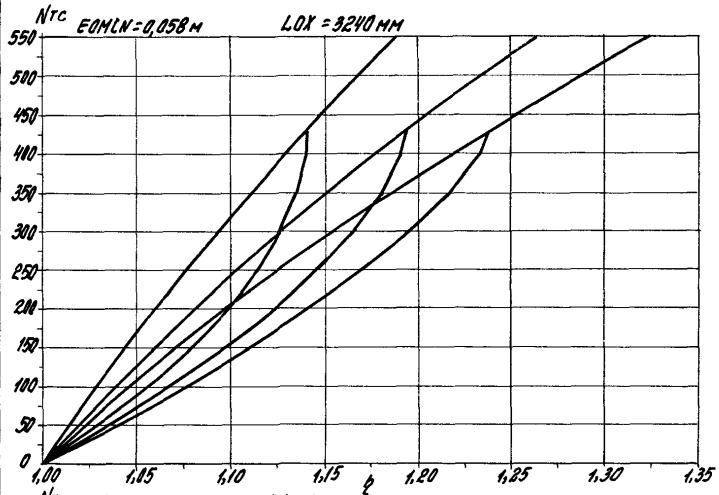

Лит. № 1000. 1.020.1-4 0-9 002

1.020.1-4 0-9 002	Авт 218
-------------------	------------

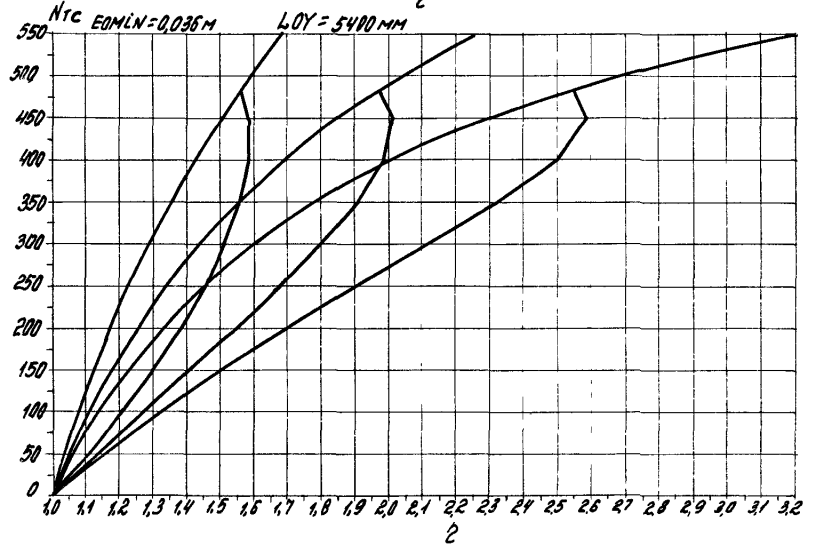
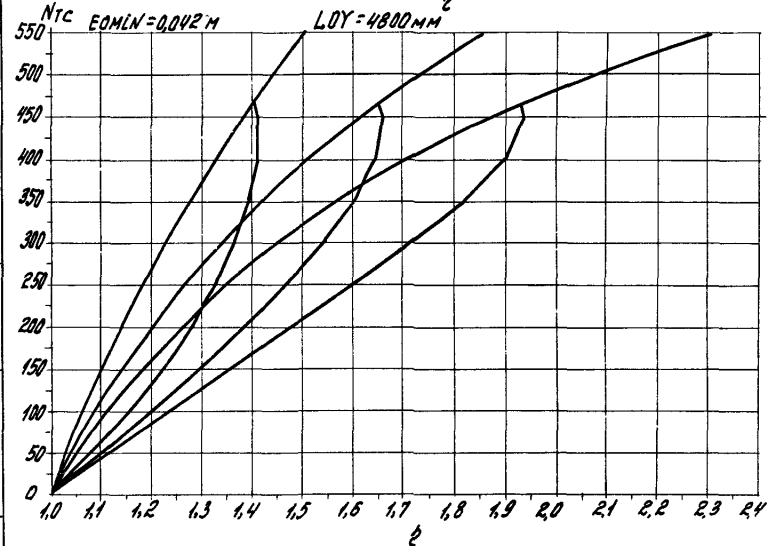
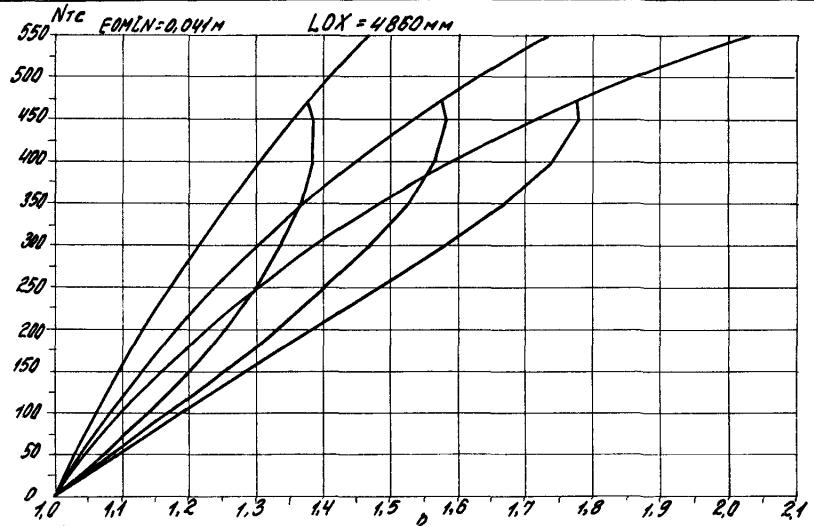

СОНД АТМОСФ. / мм 24 6 110 2010

1.020.1-4	0-9 002	штук 219
-----------	---------	-------------



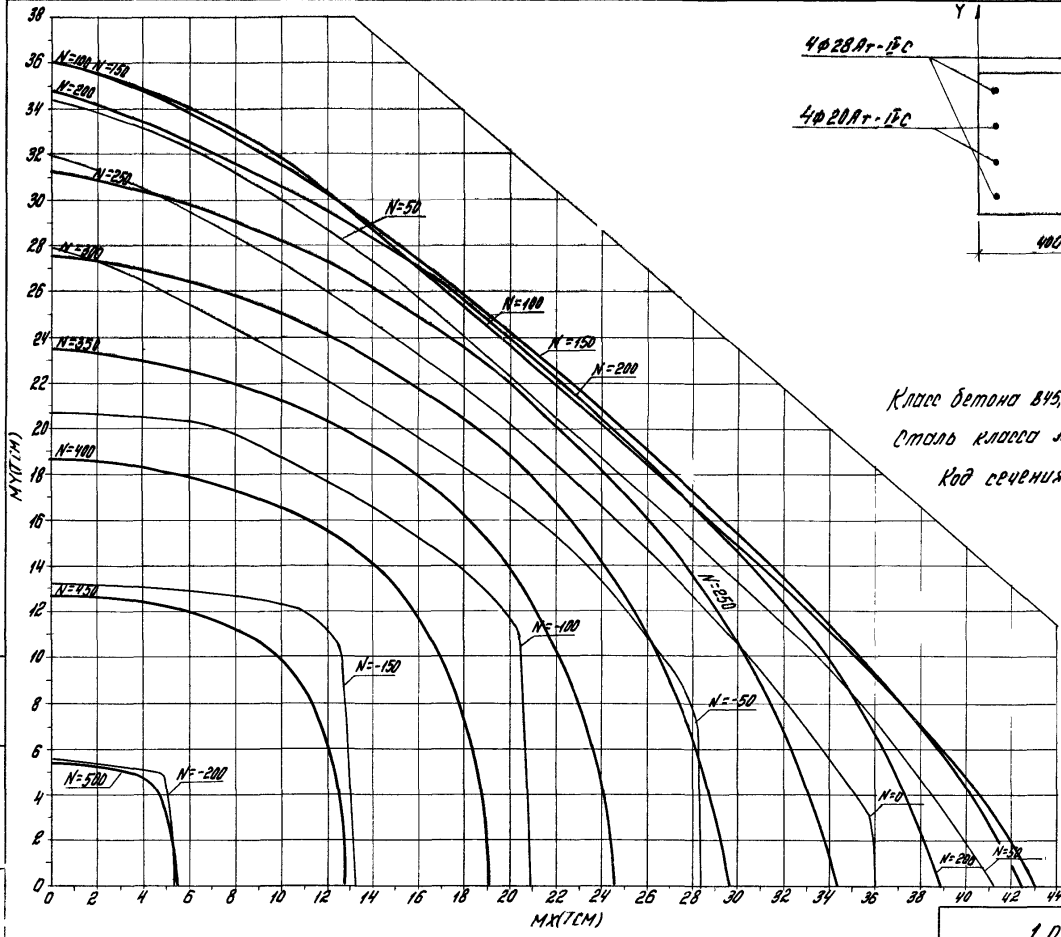
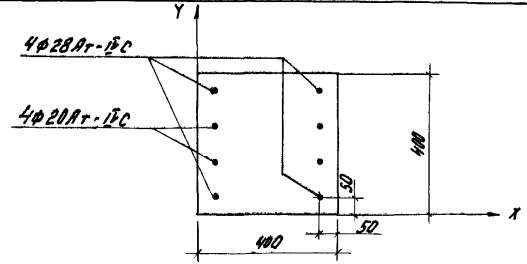

Класс бетона В15.0 ( $R_b = 22.5 \text{ МПа}$  при учете  $\gamma_{b2} = 0.90$ )  
 Сталь класса АТ-IV  
 код сечения - 128Б

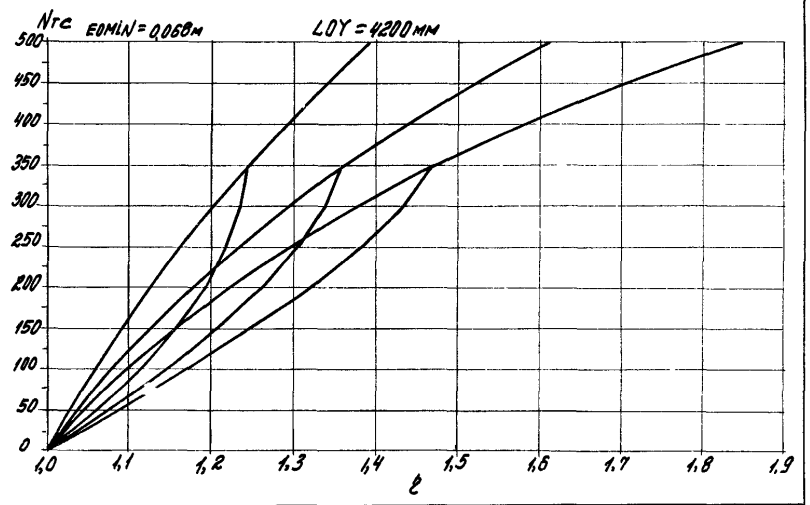
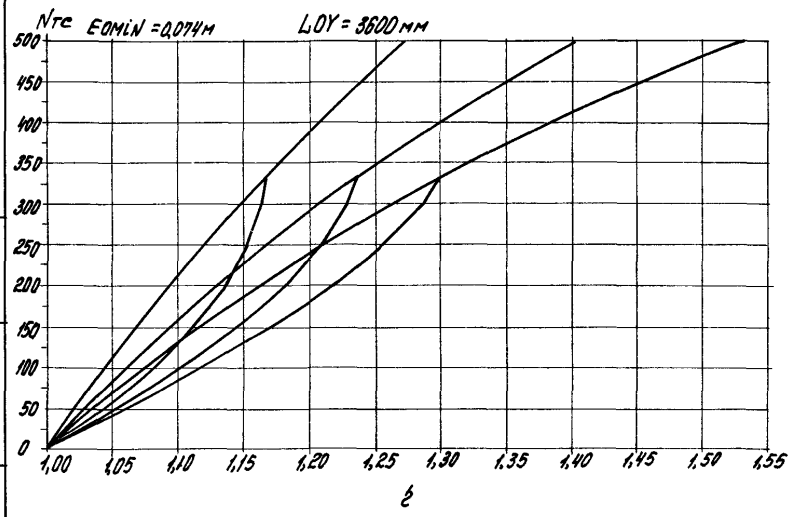
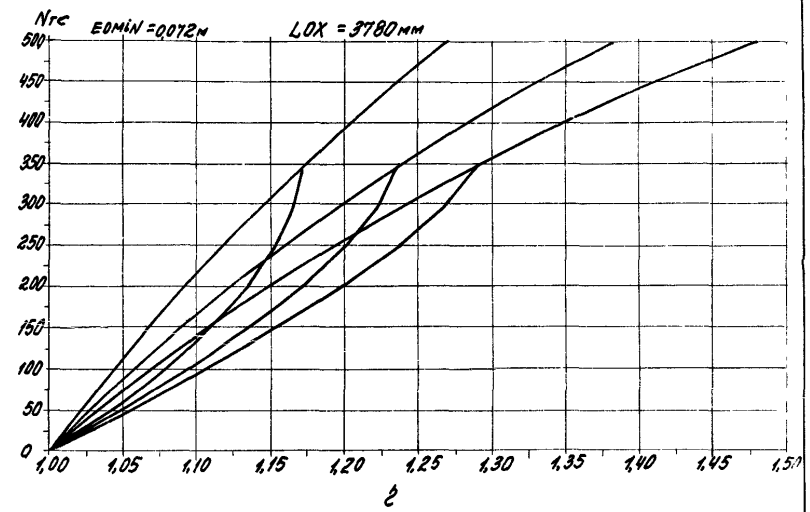
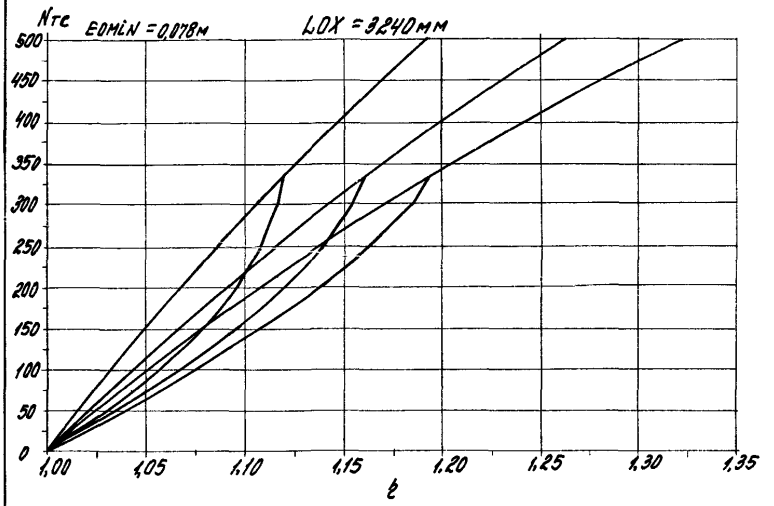

LAWRENCE LIVERMORE NATIONAL LABORATORY

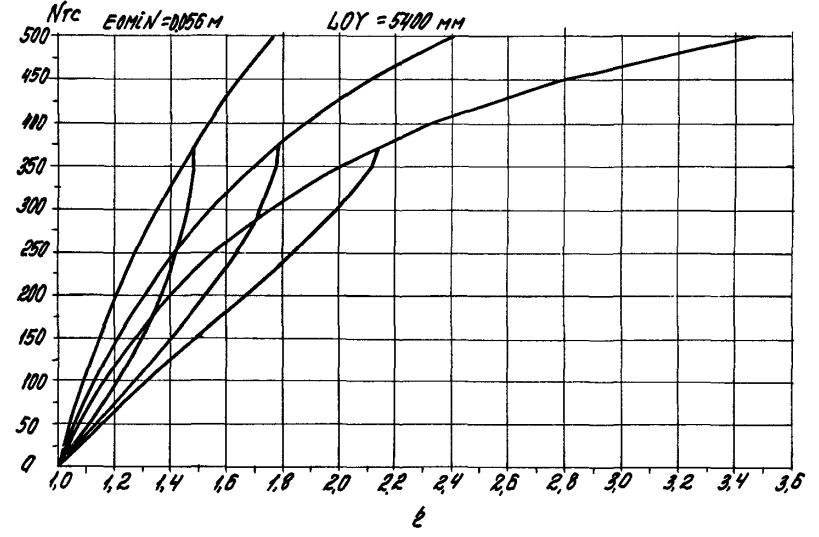
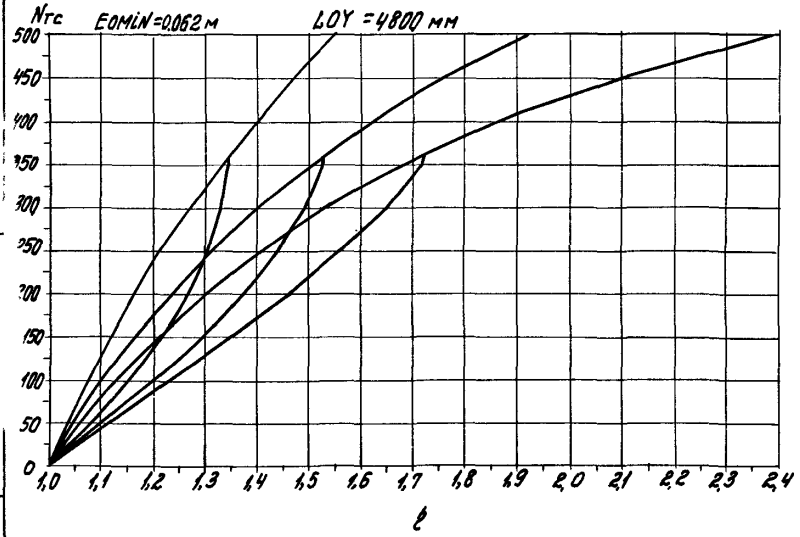
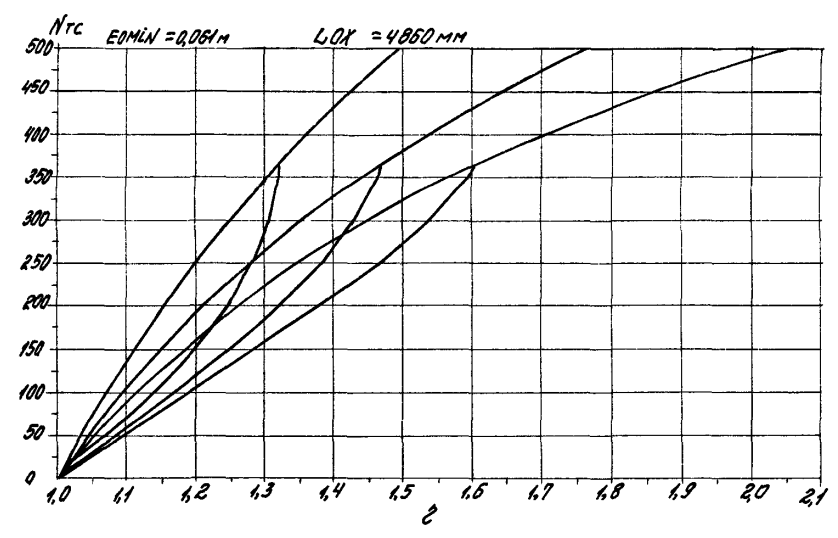
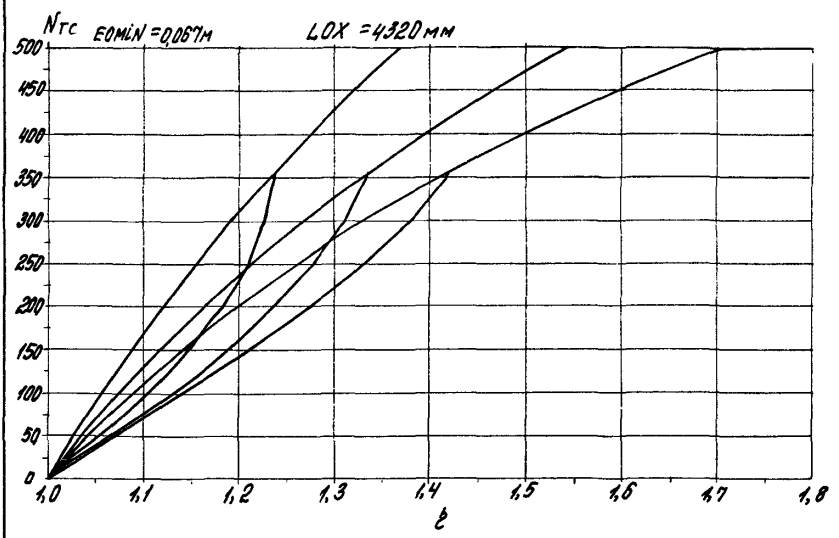

ПРОЦ. ПРОЦЕНКА И ВОЗМОЖНОСТИ В РАБОТЕ С ОБЪЕКТ. ДИСТ. АРХ.



Вед. Номер 2. Издательское учреждение: Издательство ЦАГИ

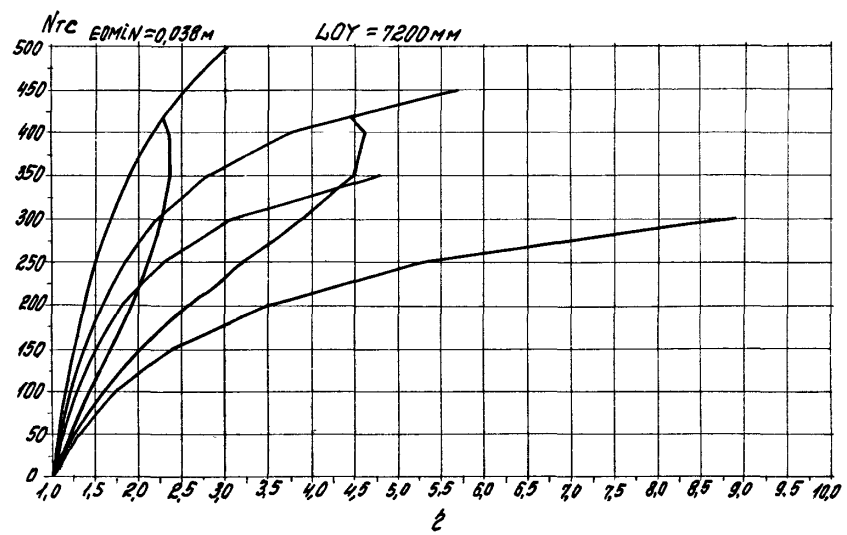
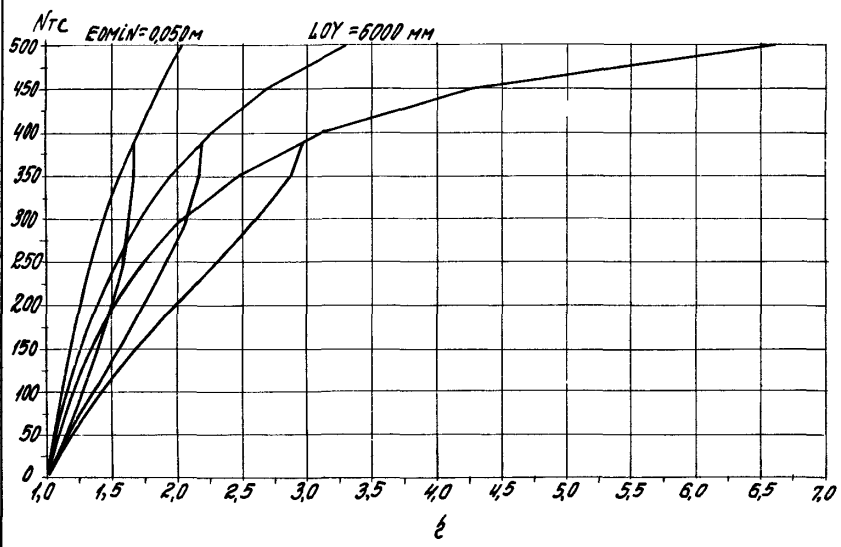
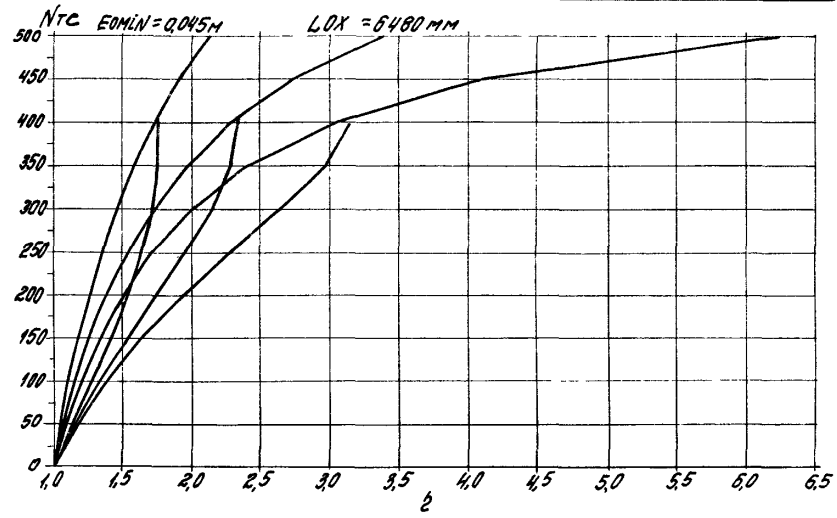
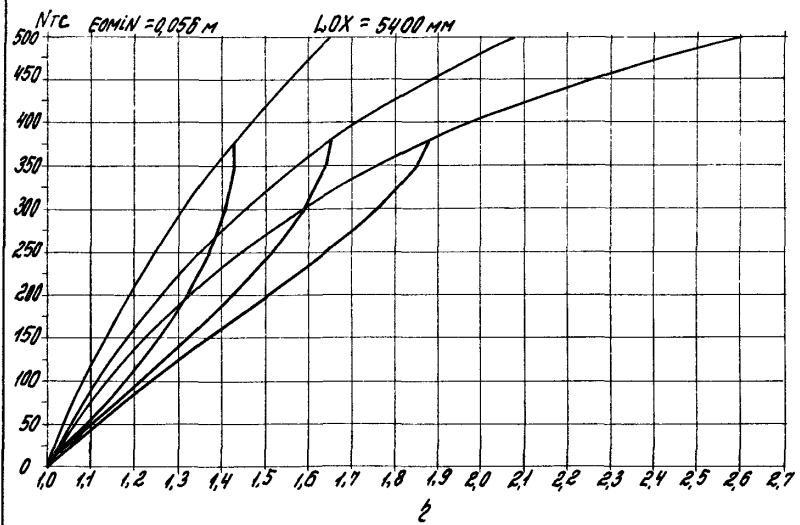

1.020.1-4 0-4 002