

ТИПОВЫЕ СТРОИТЕЛЬНЫЕ КОНСТРУКЦИИ, ИЗДЕЛИЯ И УЗЛЫ

СЕРИЯ 1.020-1/87

КОНСТРУКЦИИ КАРКАСА МЕЖВИДОВОГО ПРИМЕНЕНИЯ
ДЛЯ МНОГОЭТАЖНЫХ ОБЩЕСТВЕННЫХ ЗДАНИЙ, ПРОИЗВОДСТВЕННЫХ
И ВСПОМОГАТЕЛЬНЫХ ЗДАНИЙ ПРОМЫШЛЕННЫХ ПРЕДПРИЯТИЙ

ВЫПУСК 0-6

ГРАФИКИ НЕСУЩИХ СПОСОБНОСТЕЙ КОЛОН:
ДЛЯ ЗДАНИЙ С ВЫСОТАМИ: ЭТАЖЕЙ
4,8; 6,0 и 7,2 м

ЧАСТЬ 2

(СТР. 101...200)

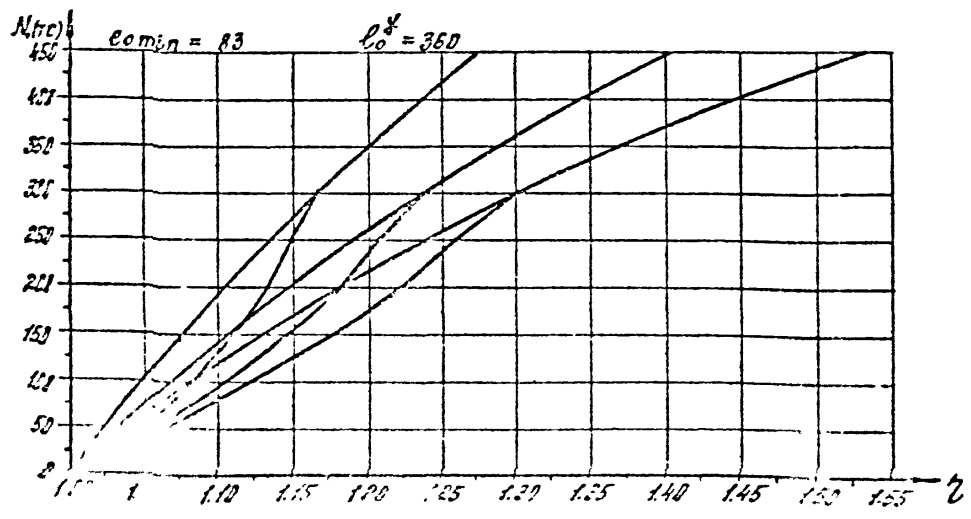
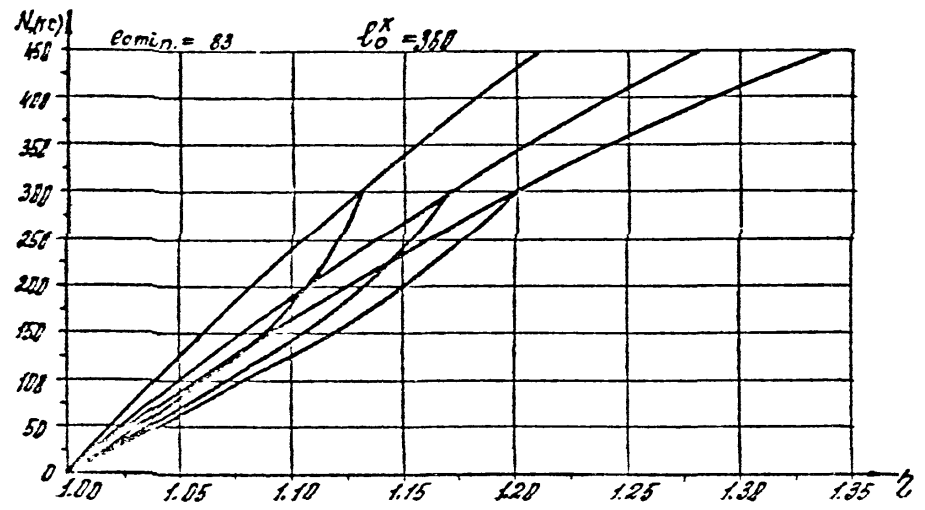

Rx. 32849 s. 103
1.020-1/87. 0-6 - 3 113
class 98

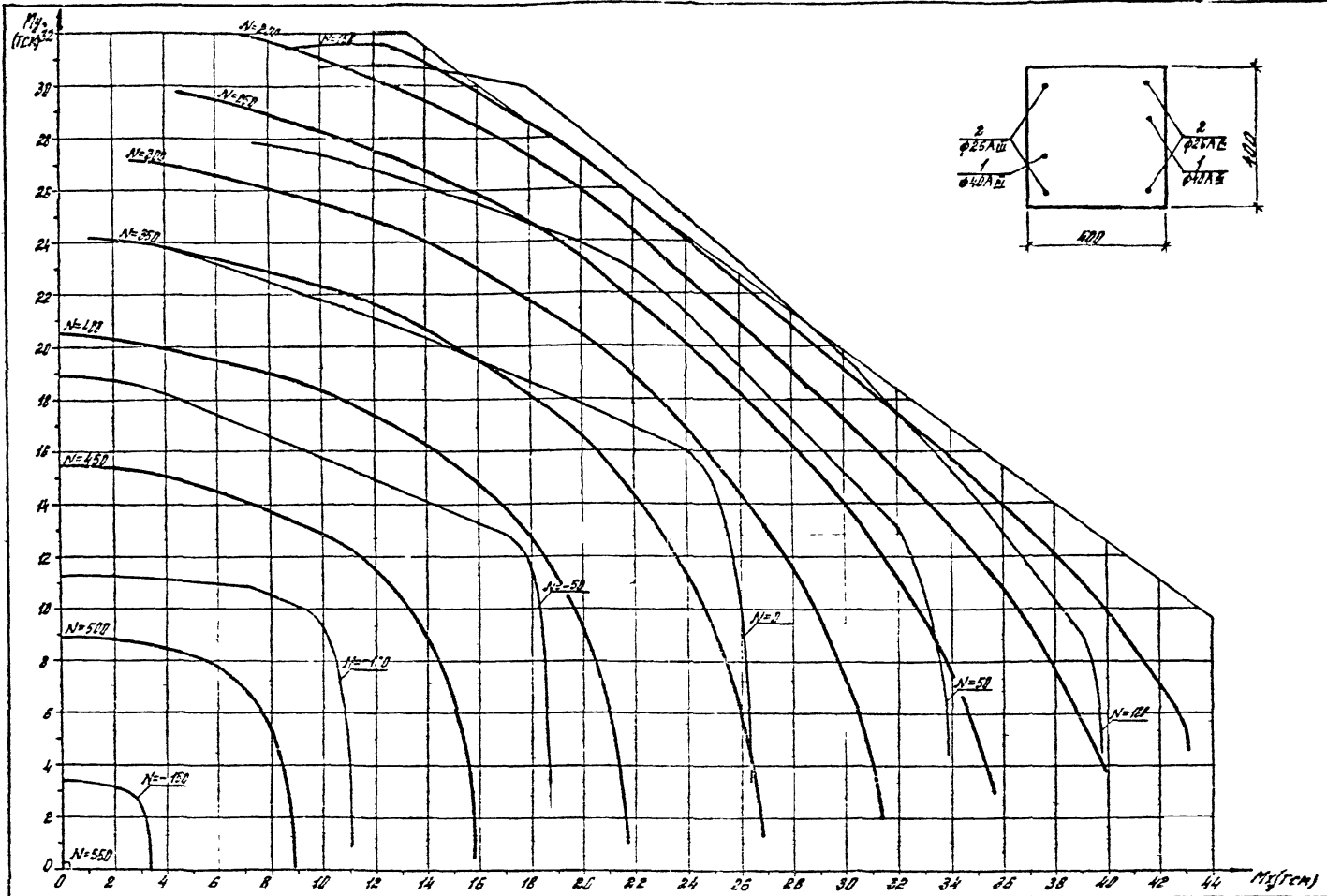

κλάση βέτονα Β40 ($R_b = 24.5 \text{ kN/cm}^2$) при $\gamma_c = 1.10$

1020-1/87. 0-6-3 π3
 32829 А.104
 97

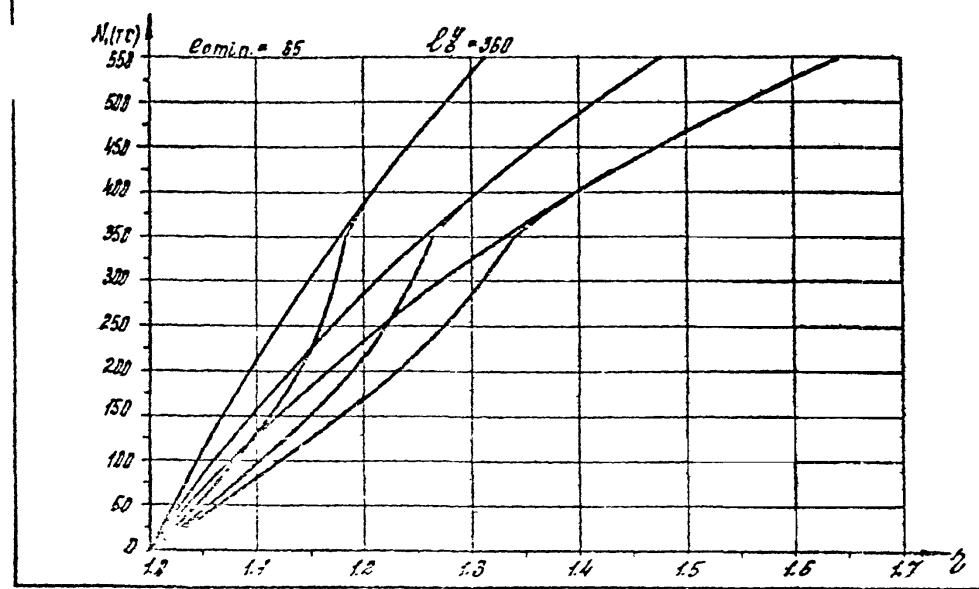
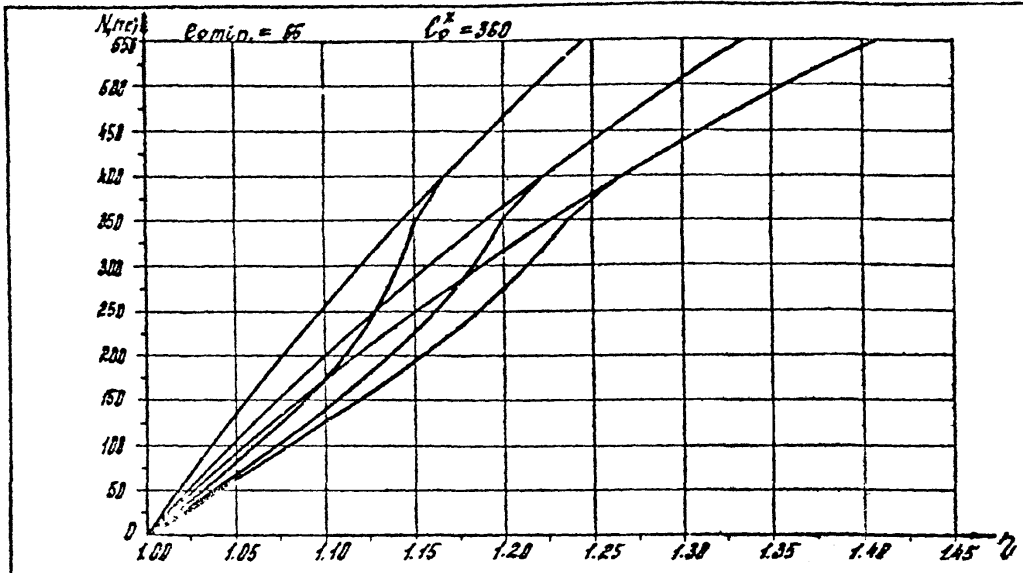

Bx 32829 A 105
1.020 - 1/87. 0-6 - 3 113
98



таблица данных В40 ($R_b = 201.6 \text{ кН/см}^2$ при учете $f_{R2} = 0.9$)

1.020-1/87. Д-5-3 ПЗ

Лист
99

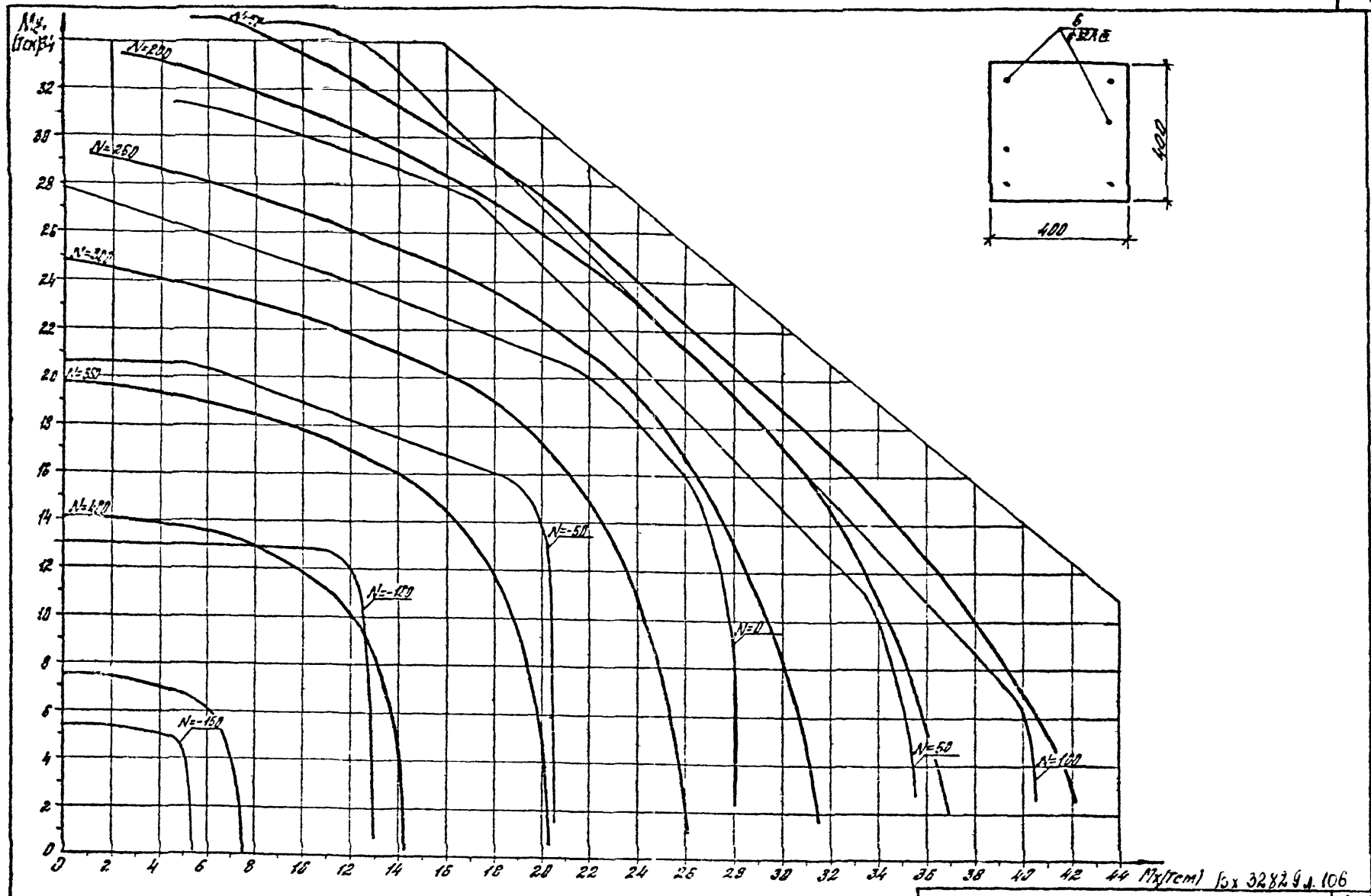
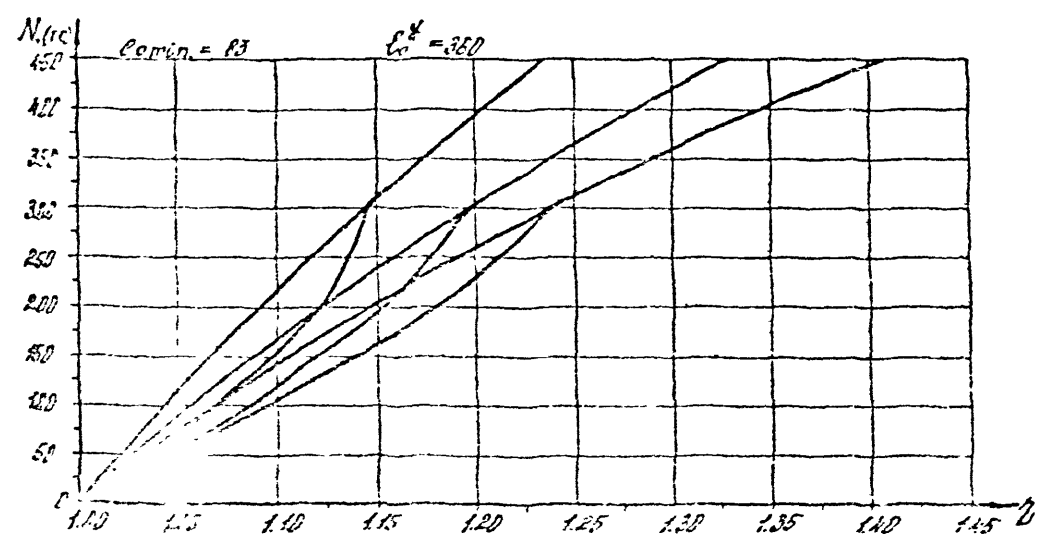
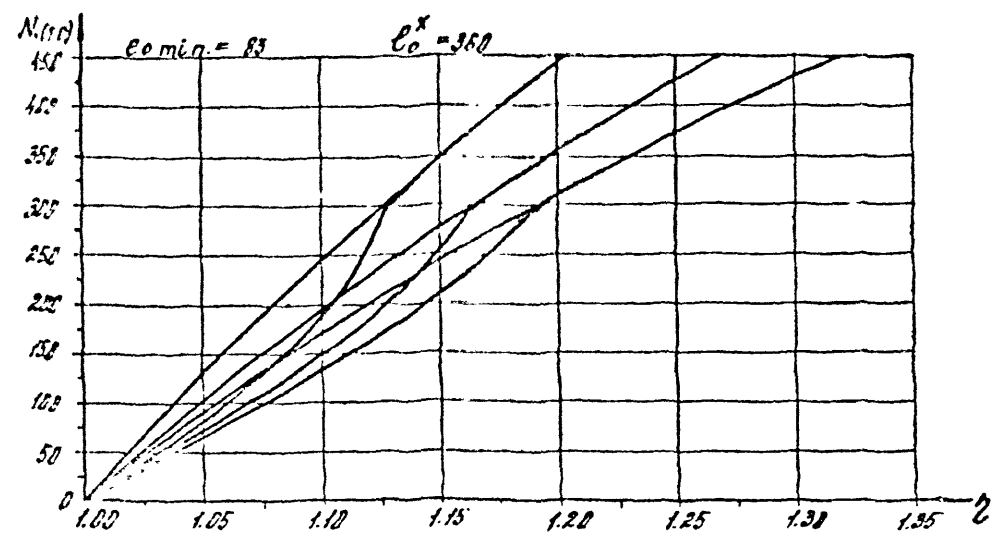

Bx. 32829 J. 104
1.020 - 1/87. 0-6-3 113

100

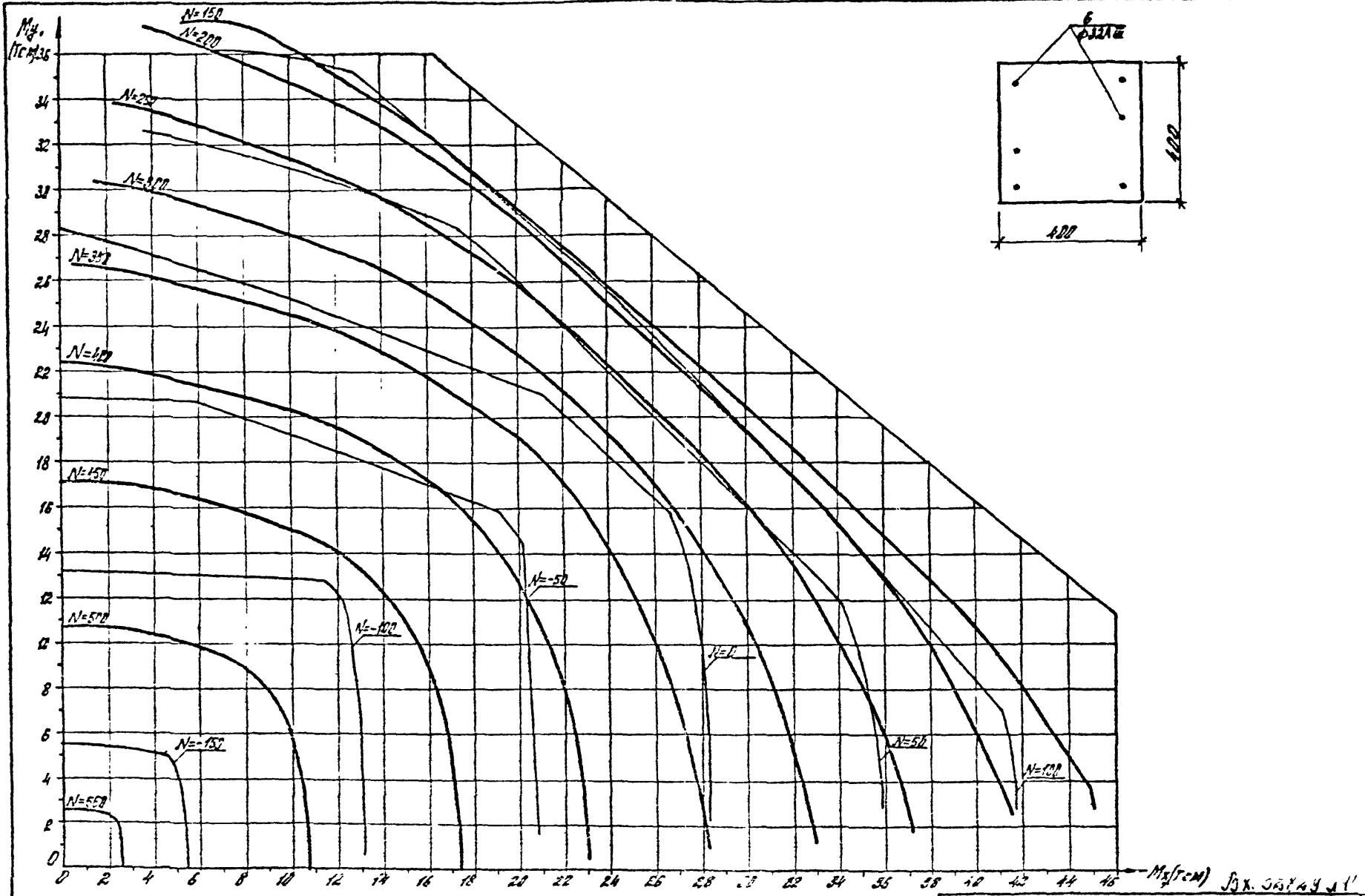

КЛАСС БЕТОНА В40 ($R_b = 24.6, 4 \text{ кг/см}^2$ при учете $\gamma_{b2} = 1.10$)

1.020-1/87. 0-6-3 ПЗ

101

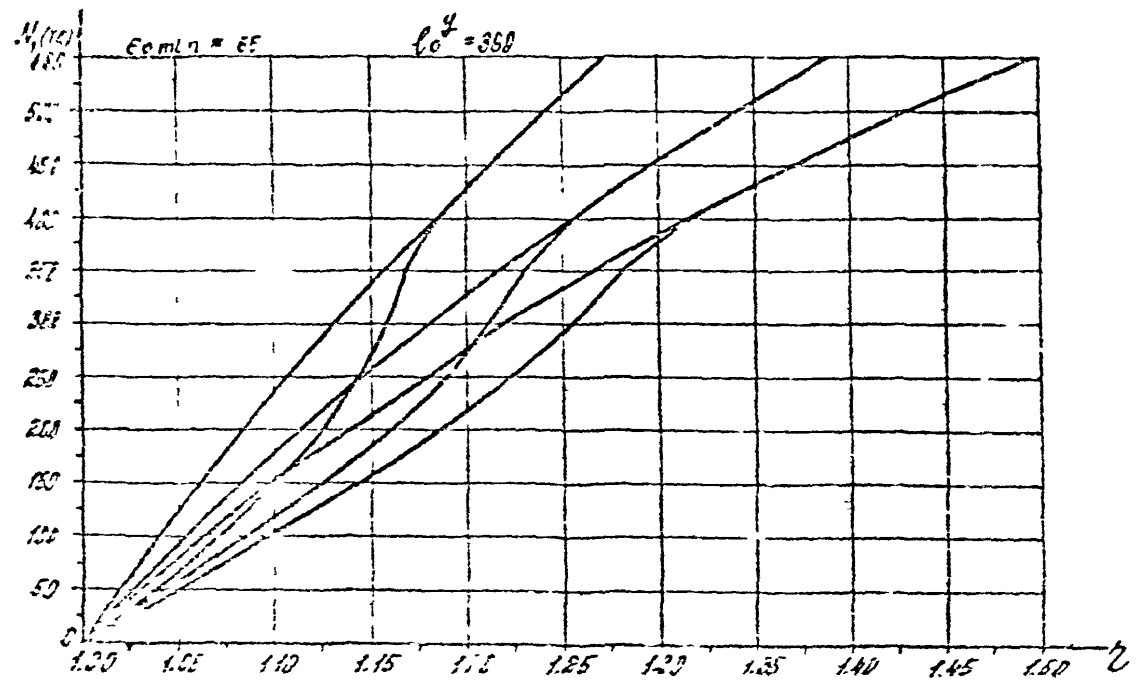
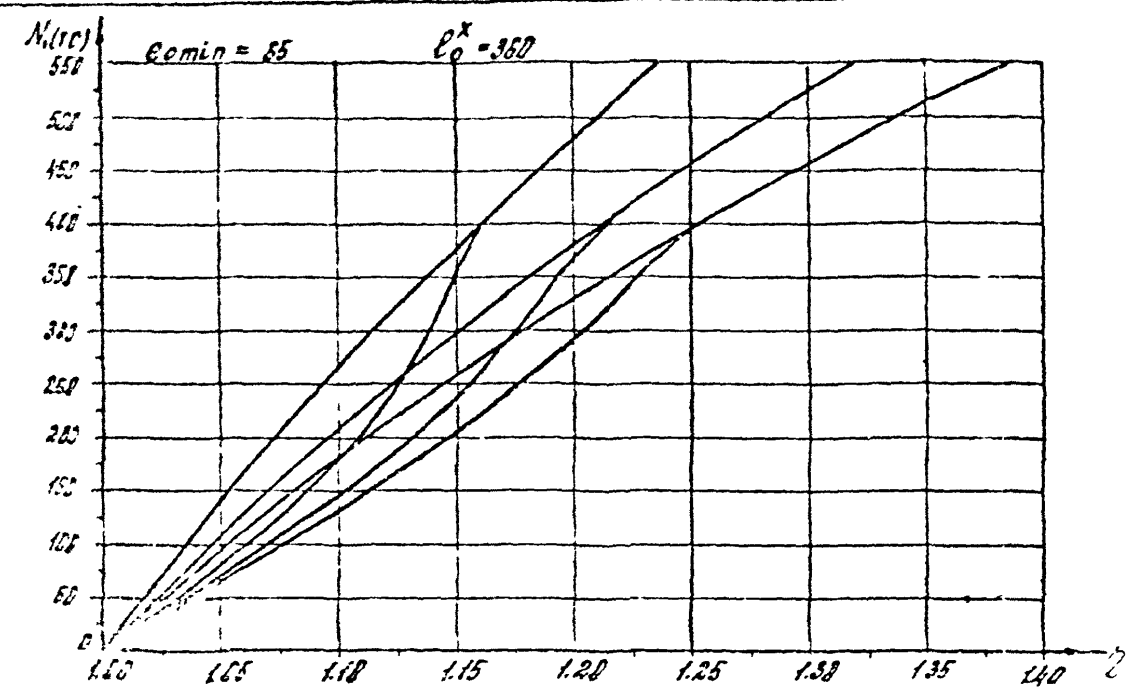

Bx. 32829 A. 109
1.020-1/87. 0-5-3 173

107

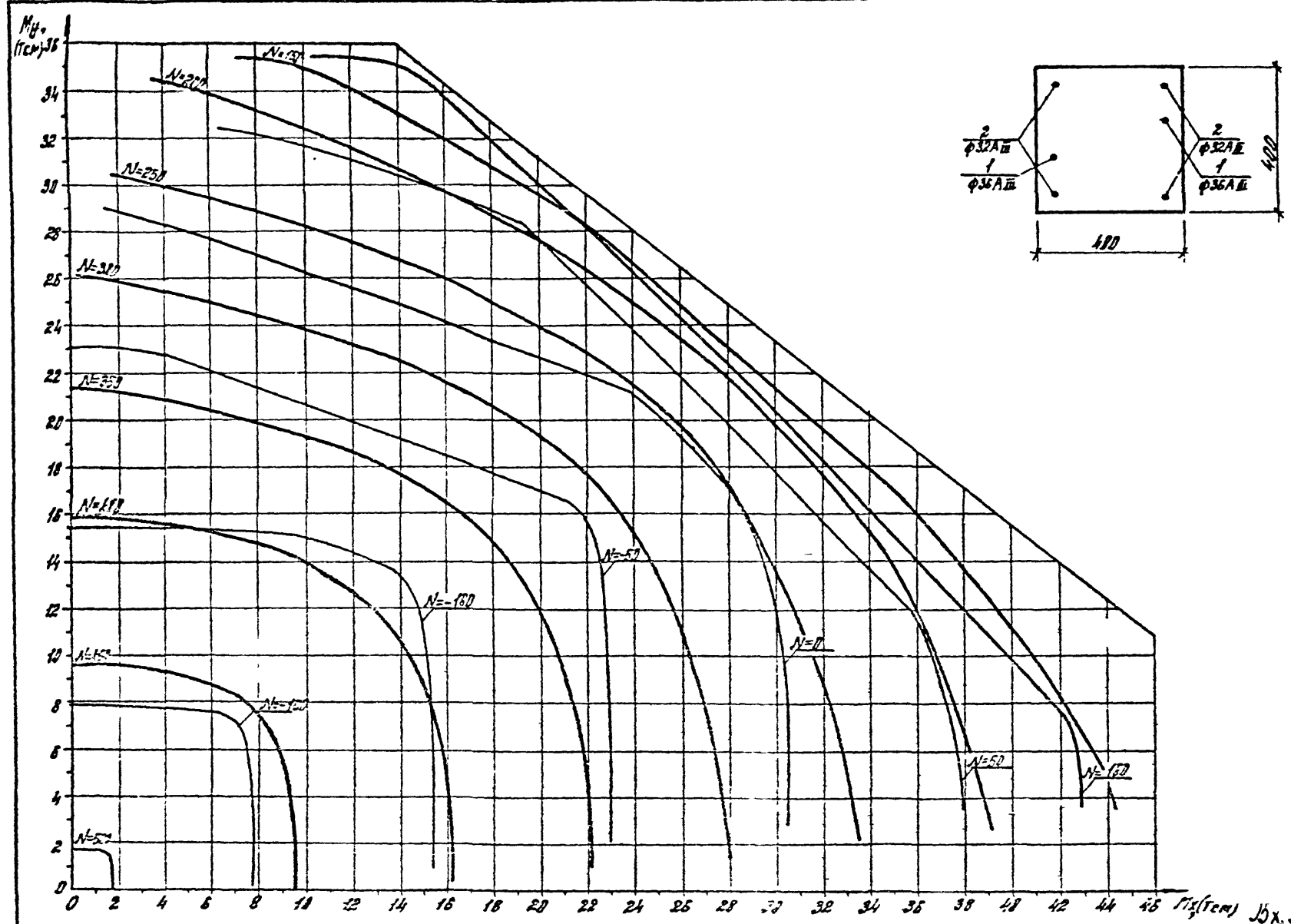

Бетон В40 ($R_B = 201.5 \text{ кгс/см}^2$ при $\beta_e = 0.9$)

1020-1/87. 0-5-313

103

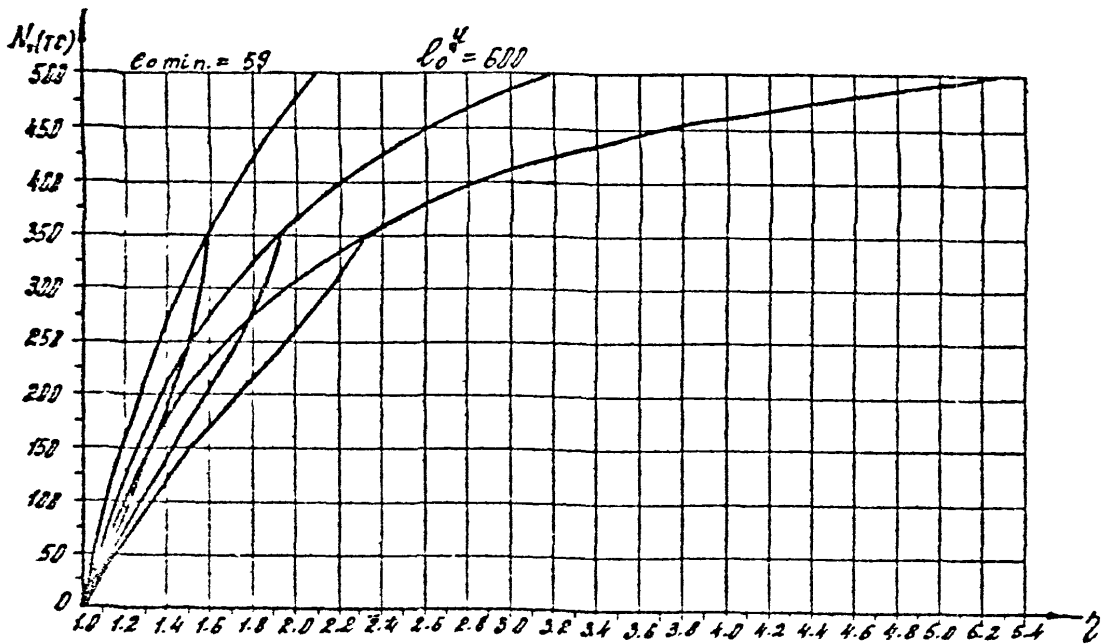
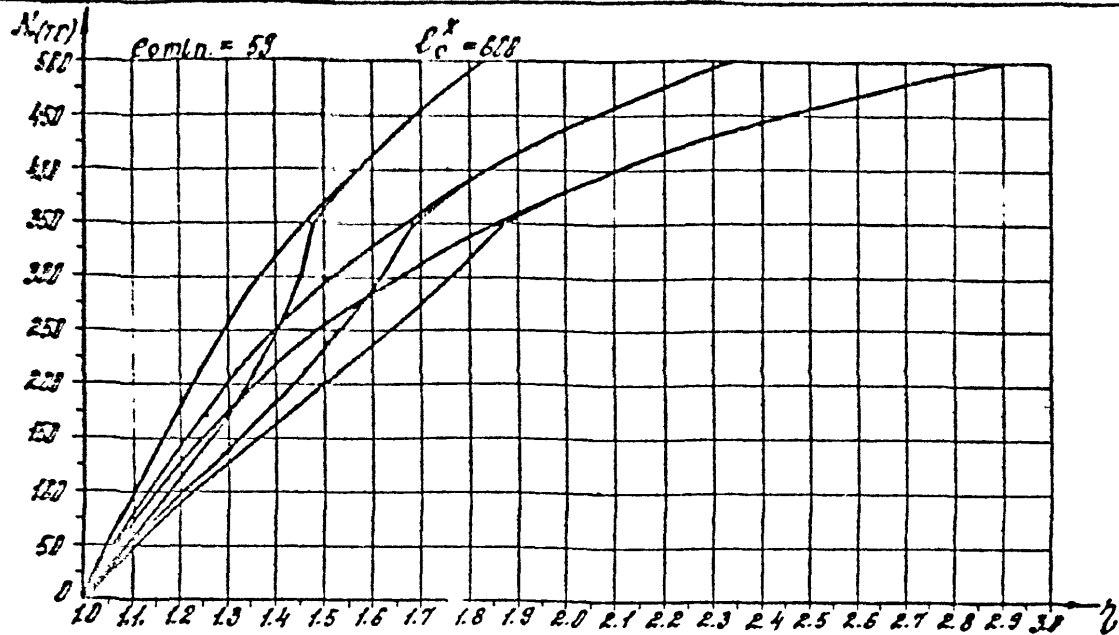

Box 32829 A.111

1.020-1/87. 0-6-3113

104

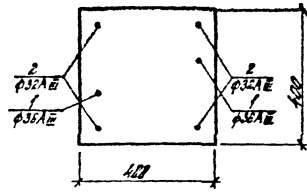
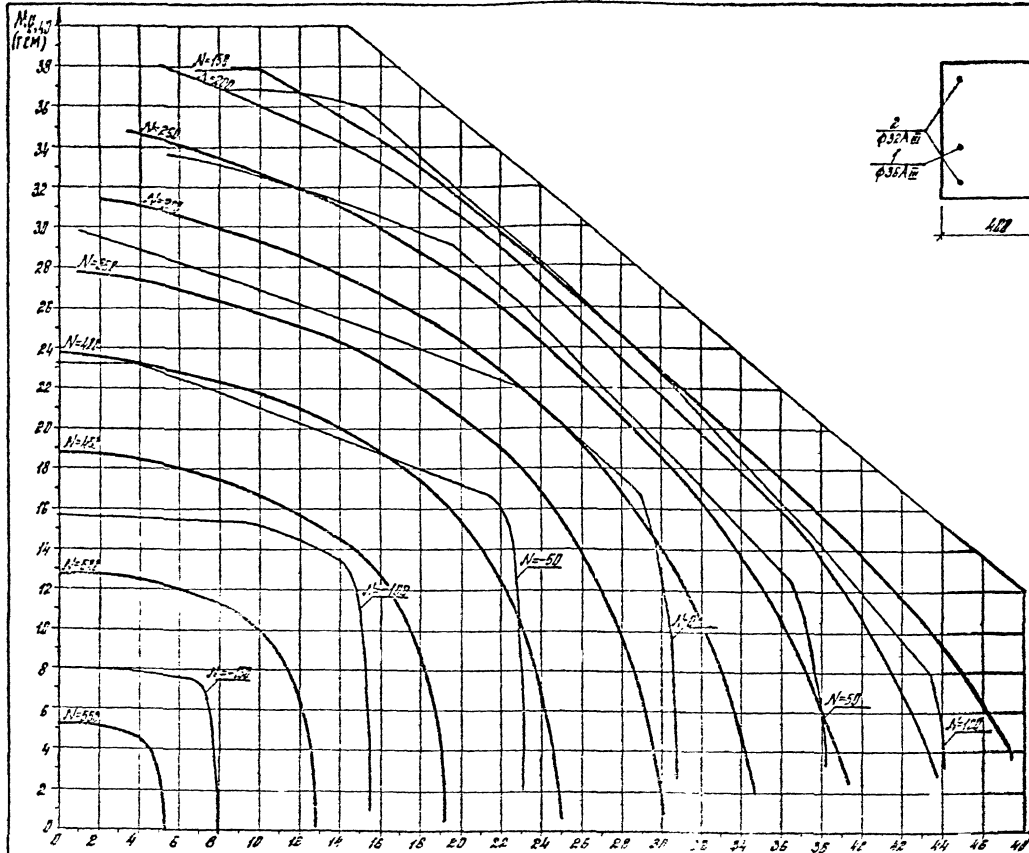

класс бетона В40 ($R_b = 21.6 \text{ МПа}$ при учете $\gamma_{cc} = 1.10$)

M_d (кНм) Д-32823А-116

1.020-1/87. Д-6-3.13

105

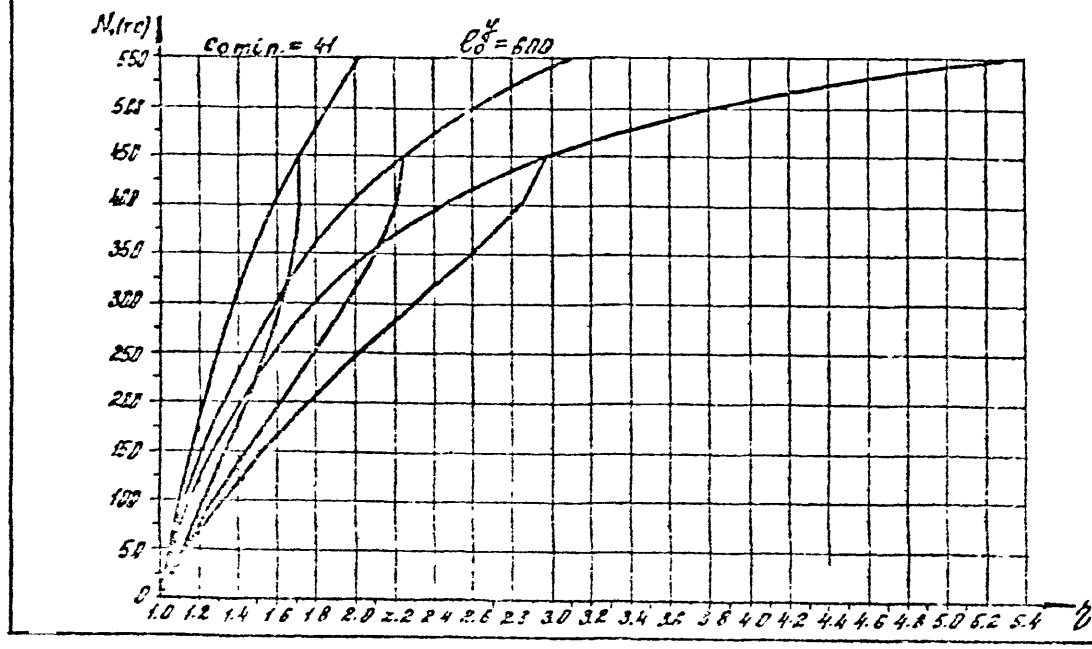
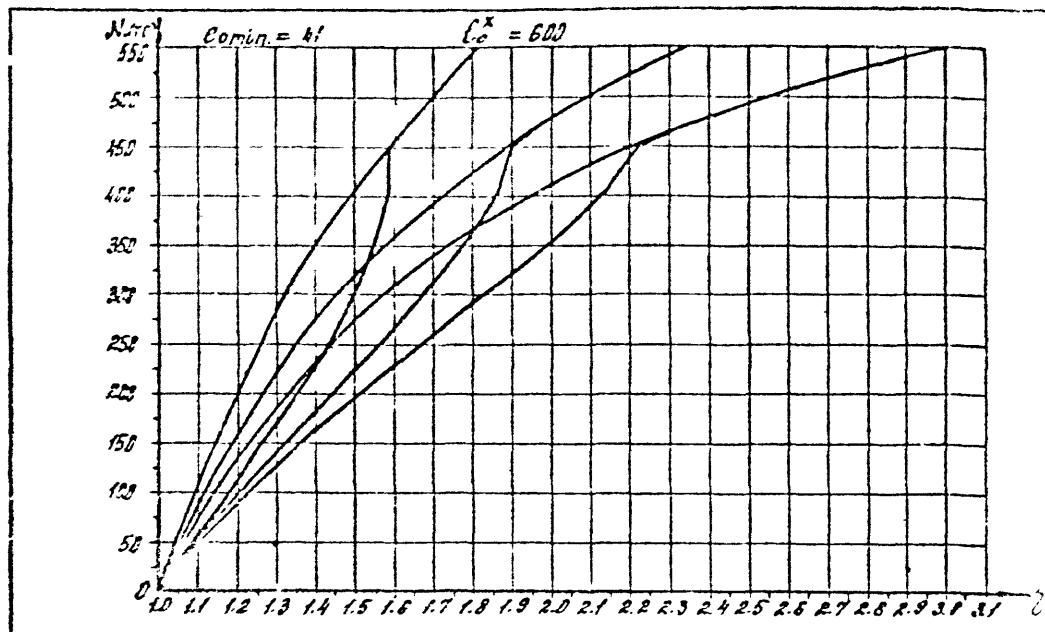

Jbx 32829 J. 113
 1.020-1/87. 0-5-3 N3

200
100

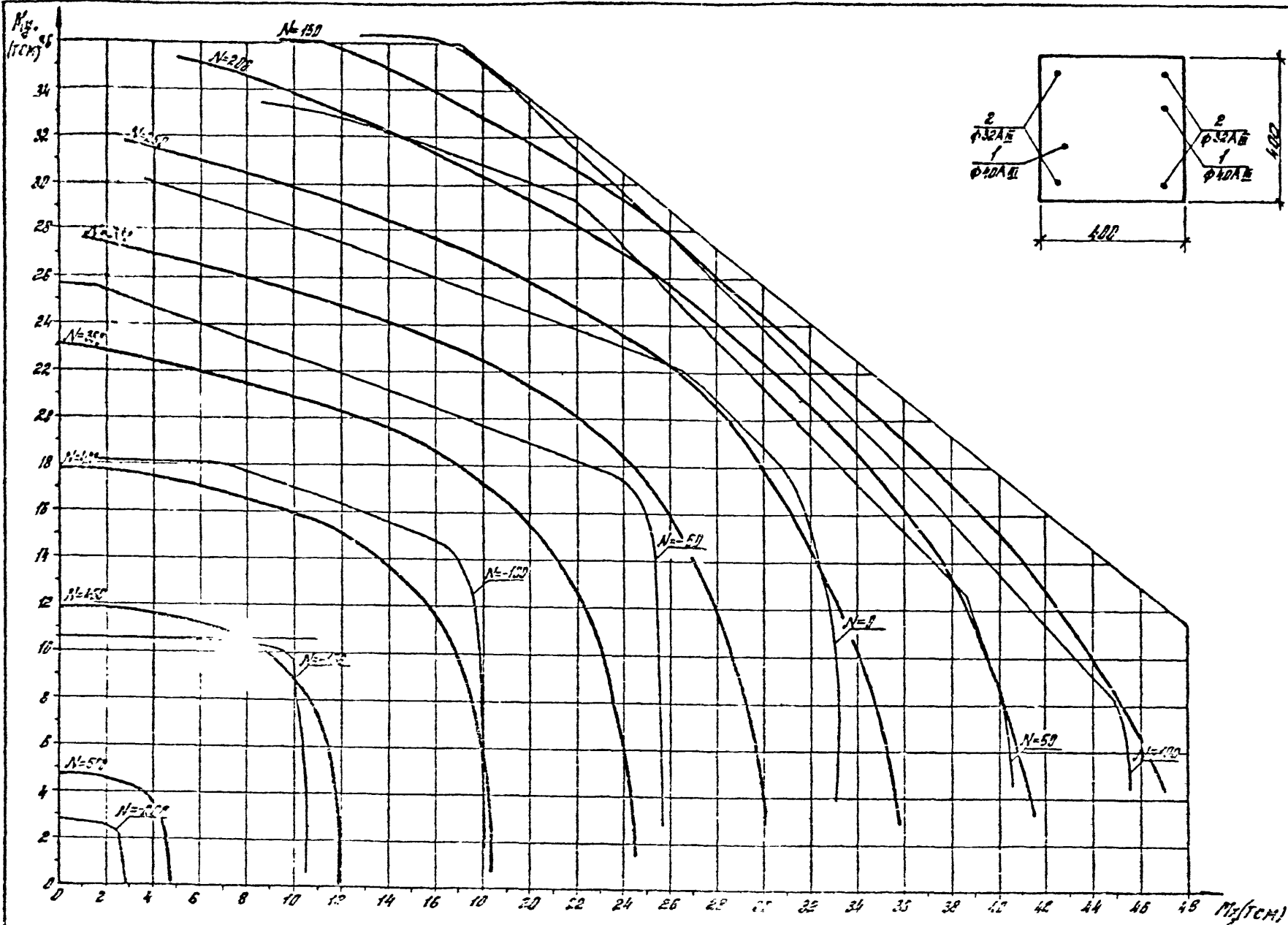

модель БТМ-100 (RS=200, $\sigma_{max} = 10^8$ при $\nu = 0.2$)

1.020 - 1/87. 0-6-3 113

Вх. 32829 з. 114

107

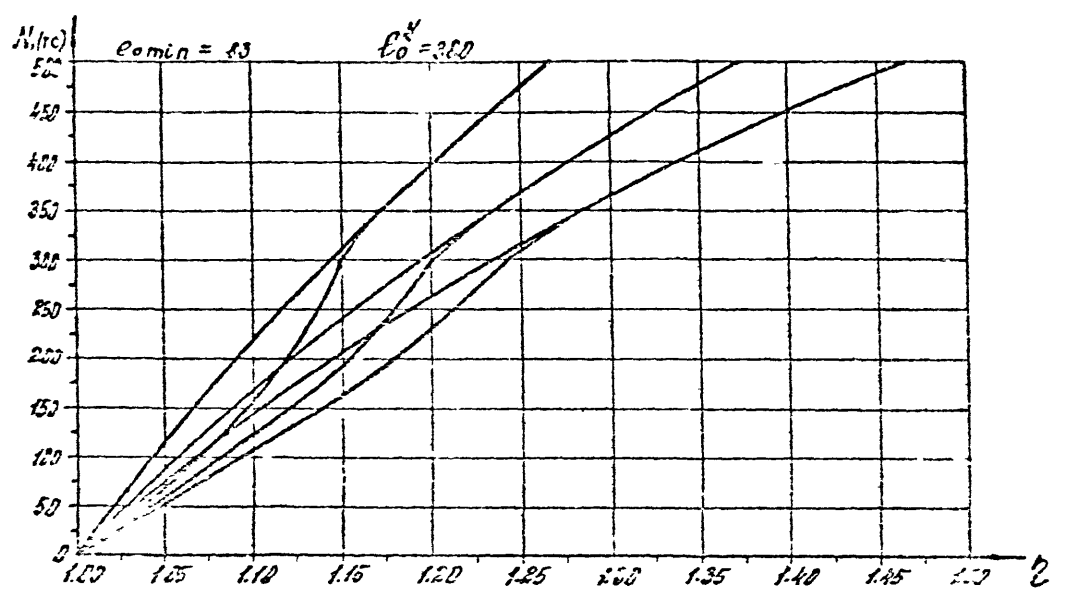
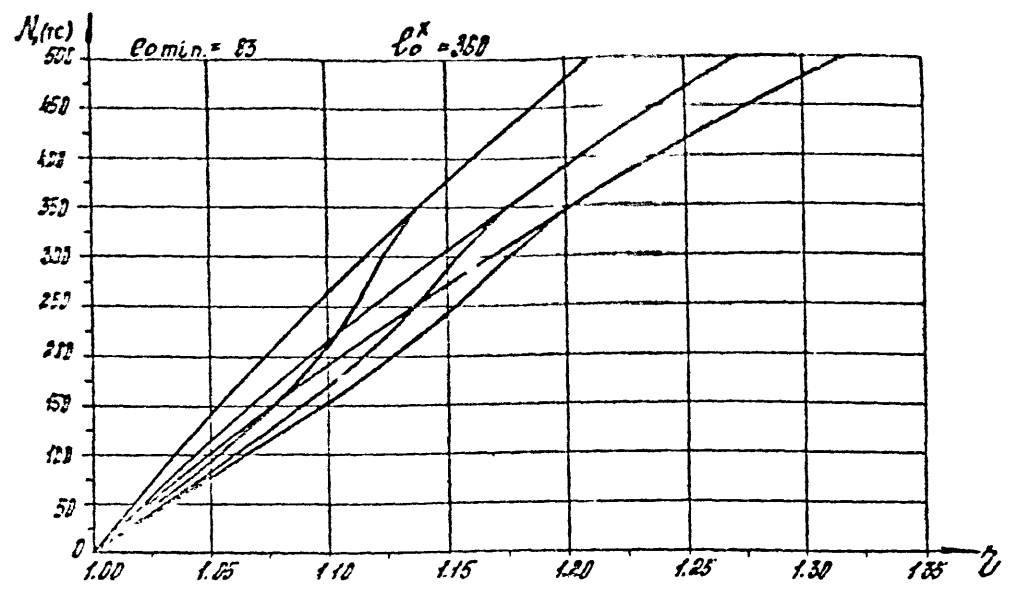

Bx. 26829A115
1020-1187. 0-6-3113

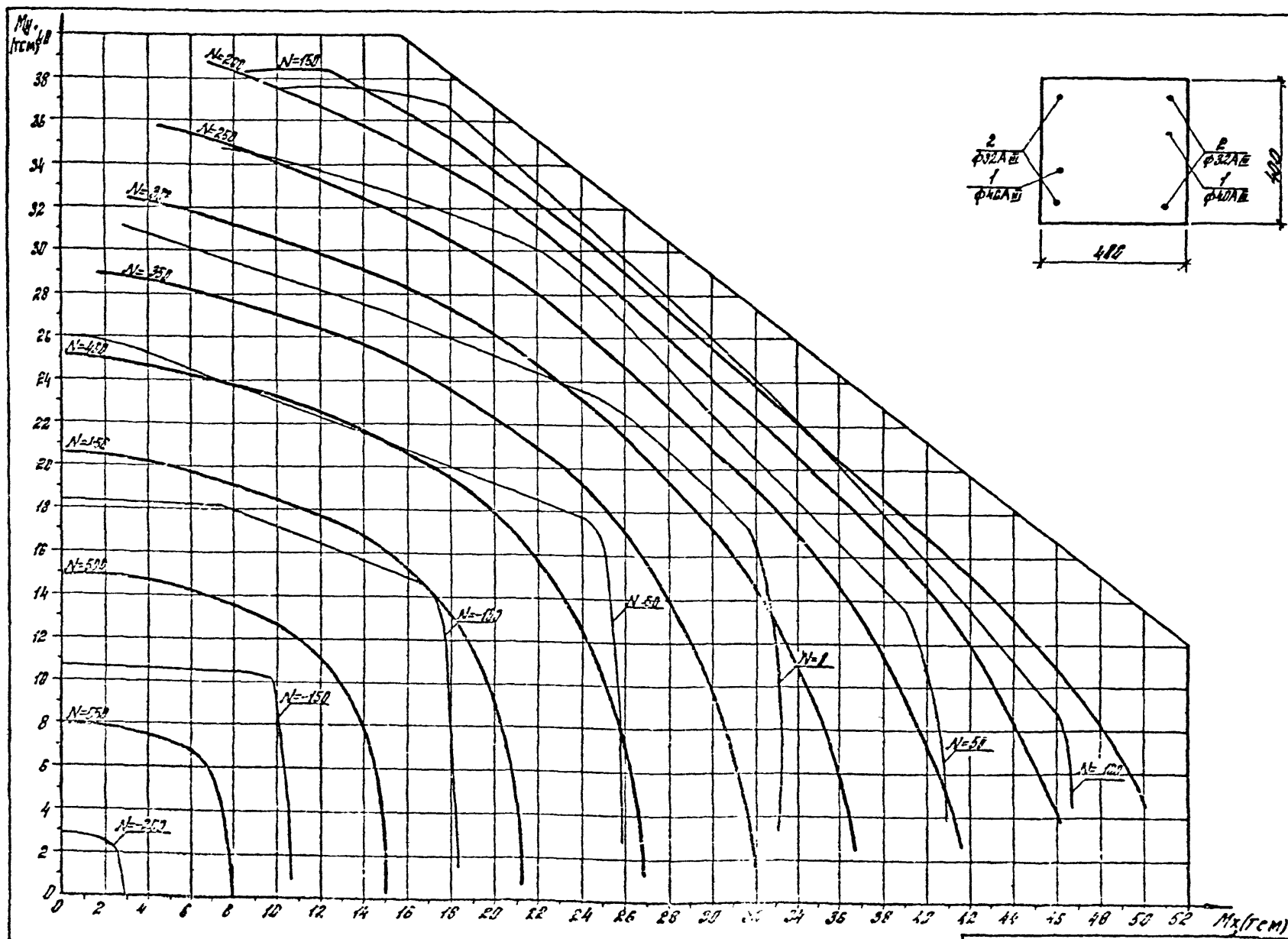

РАСЧЕТ ОБЪЕМА ВЪД $(R_s = 245 \text{ кг/см}^2 \text{ при } \gamma_{\text{вд}} = 1,12)$

1.020-1/87.0-6-313

Вх. 32829 л. 116

108

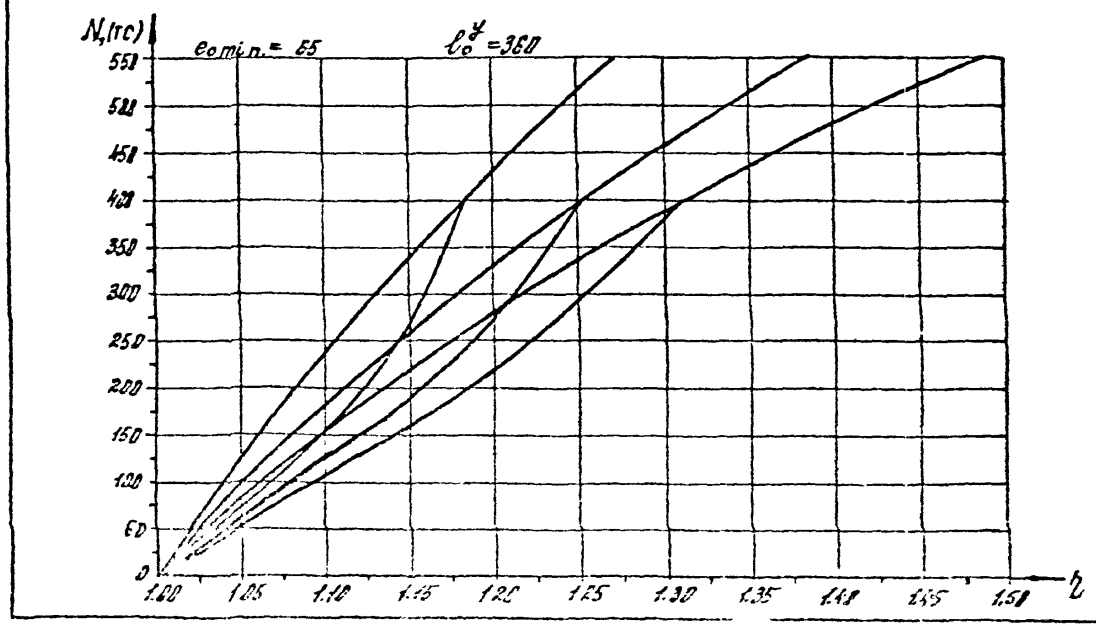
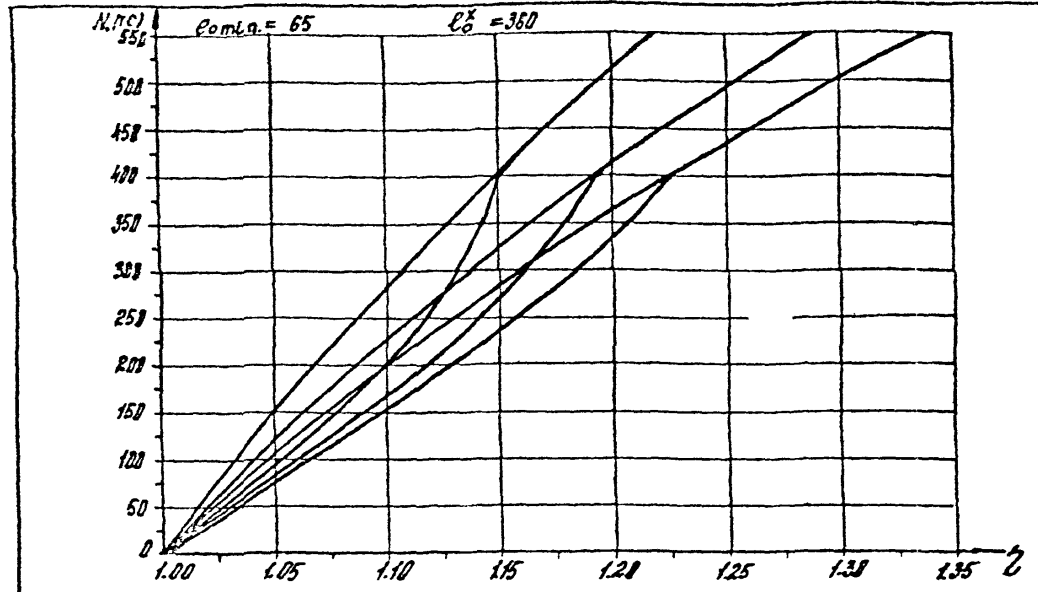

Box 32829 u. 11 f
1.020-1/87. 0-6-3 113

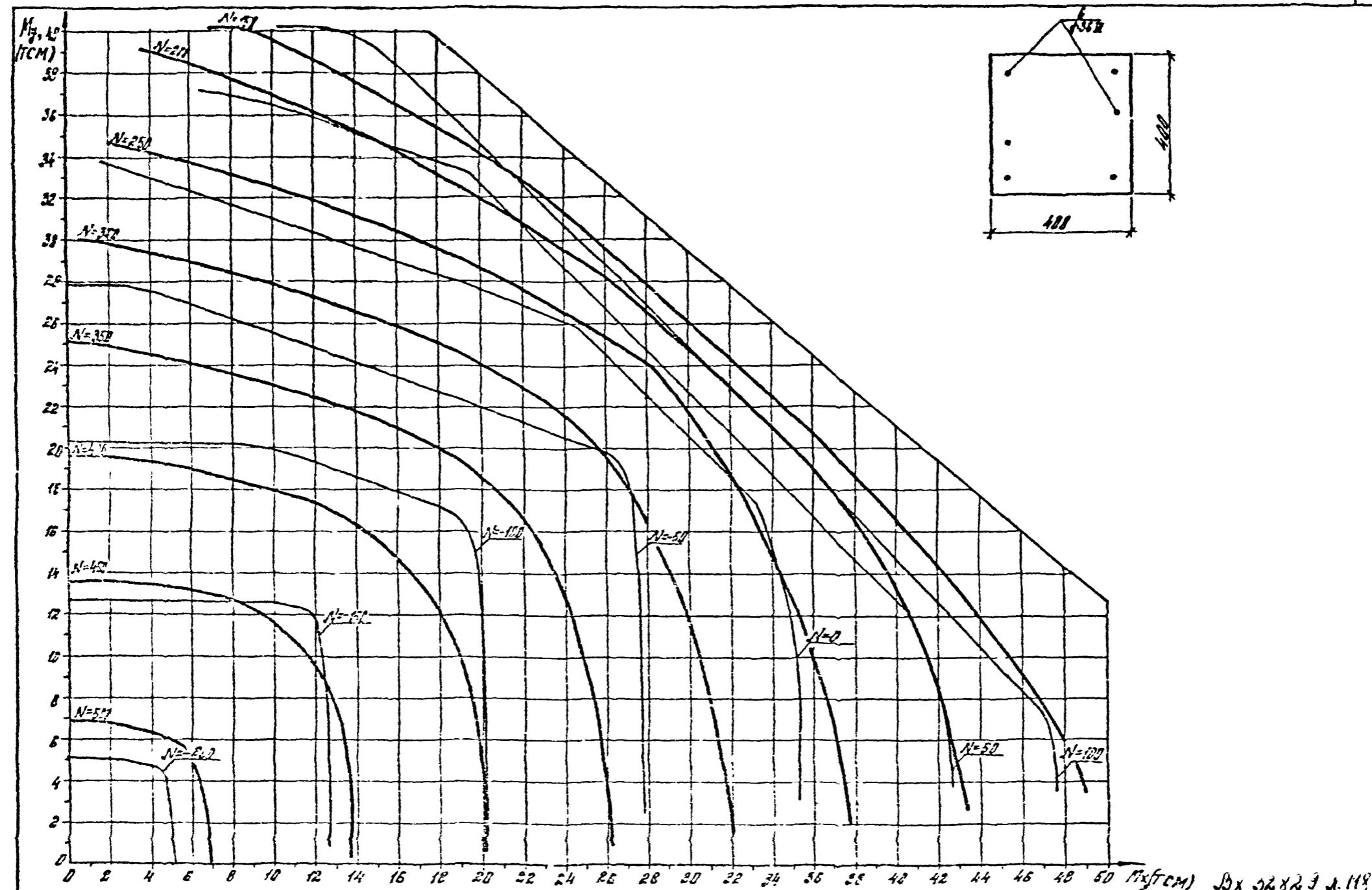

Бетон В40 ($R_b = 20 \text{ т/см}^2$ при $\mu_{ст} = 0.9$)

1.020-1187. 0-5-3 ПЗ

стр. 111

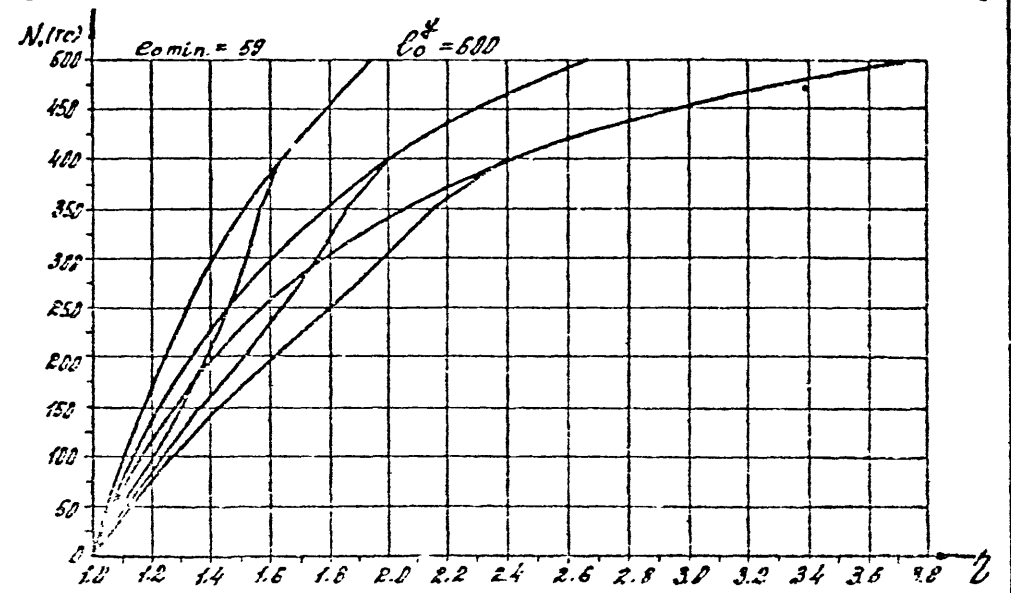
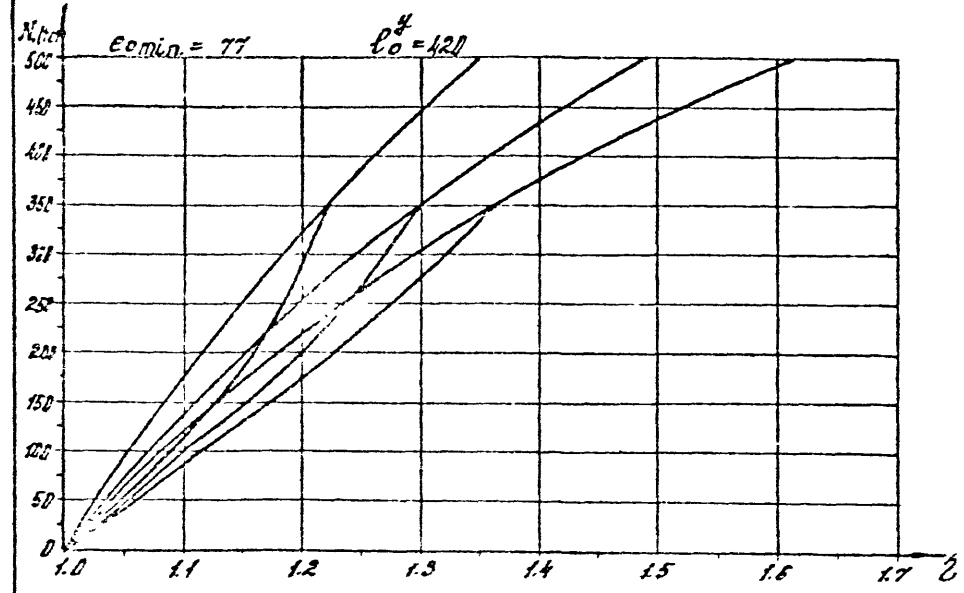
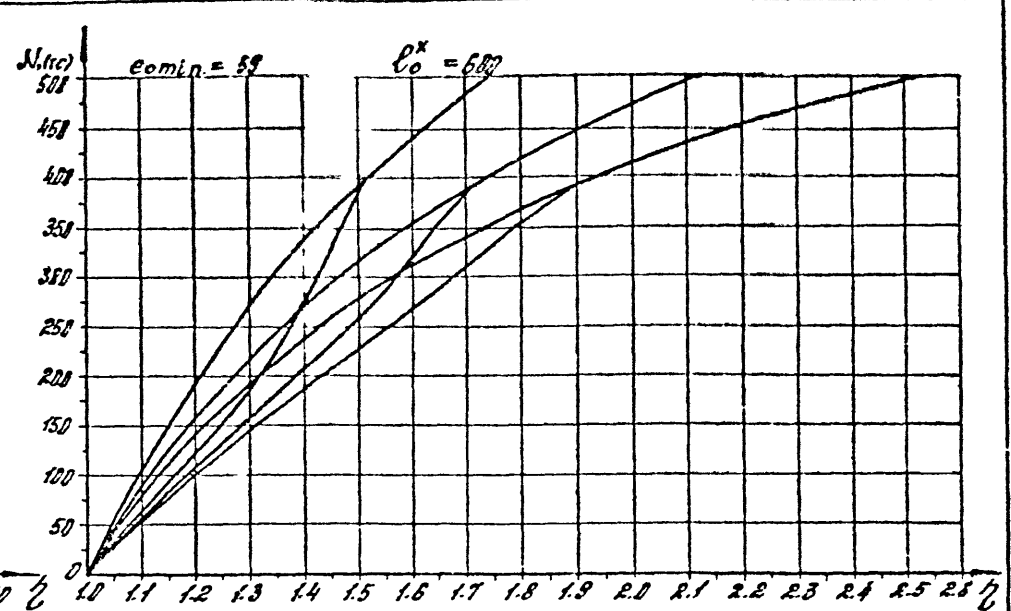
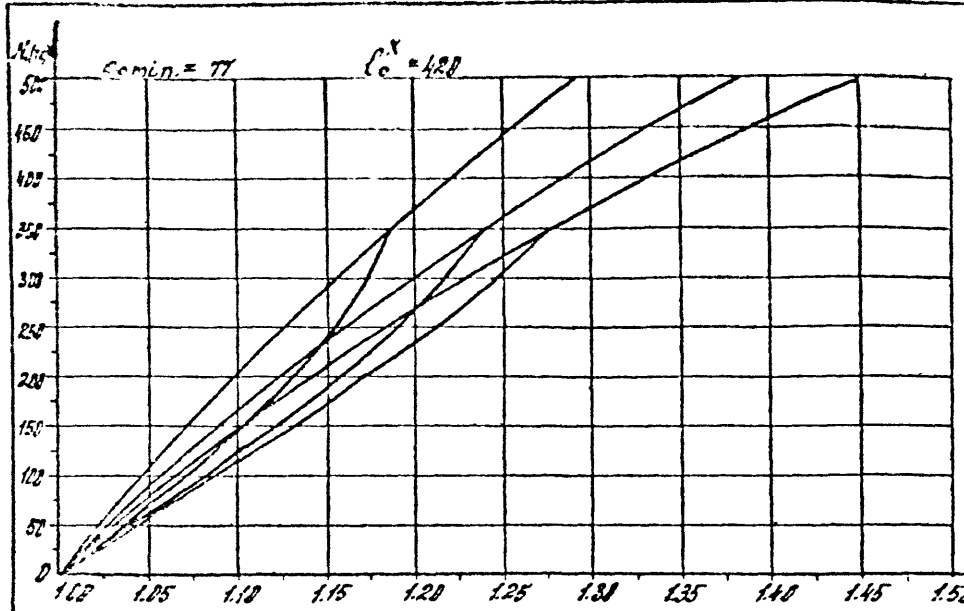

Bx. 32829 J. 119

1.020-1.87. 0-6-3 173

112
112

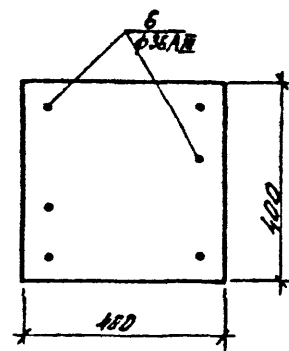
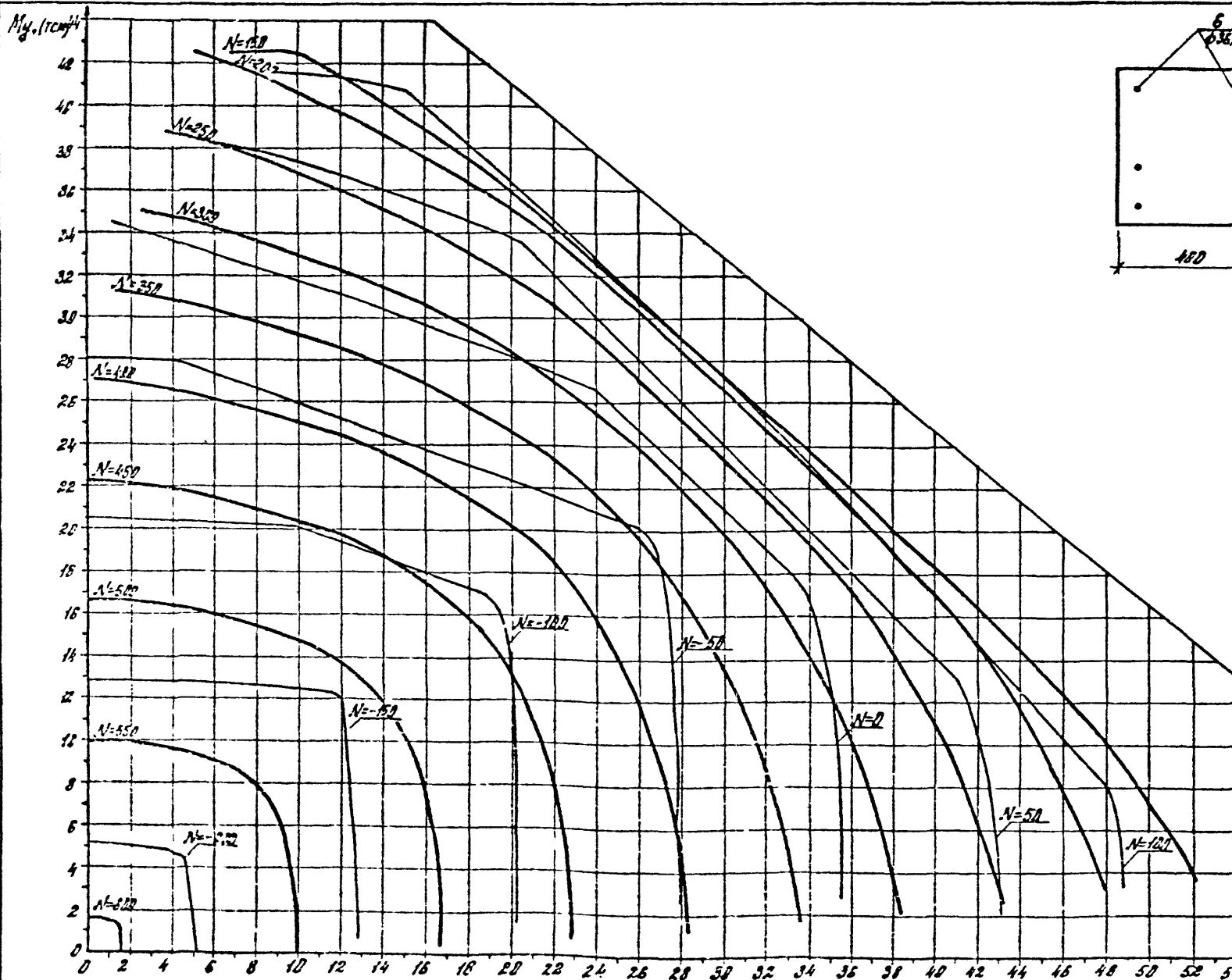

класс бетона B40 ($R_B = 24.6 \text{ тс/см}^2$ при $\gamma_{\text{це}} = 1.10$)

1.020-1/87. 0-6-3113

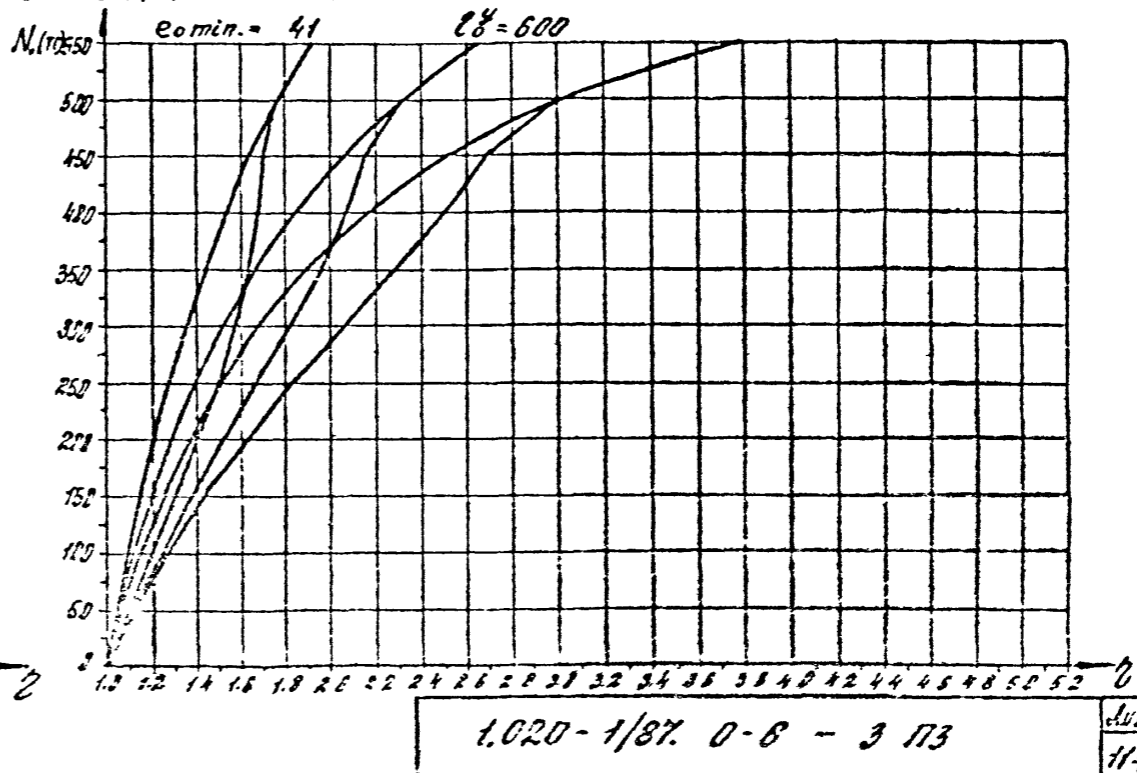
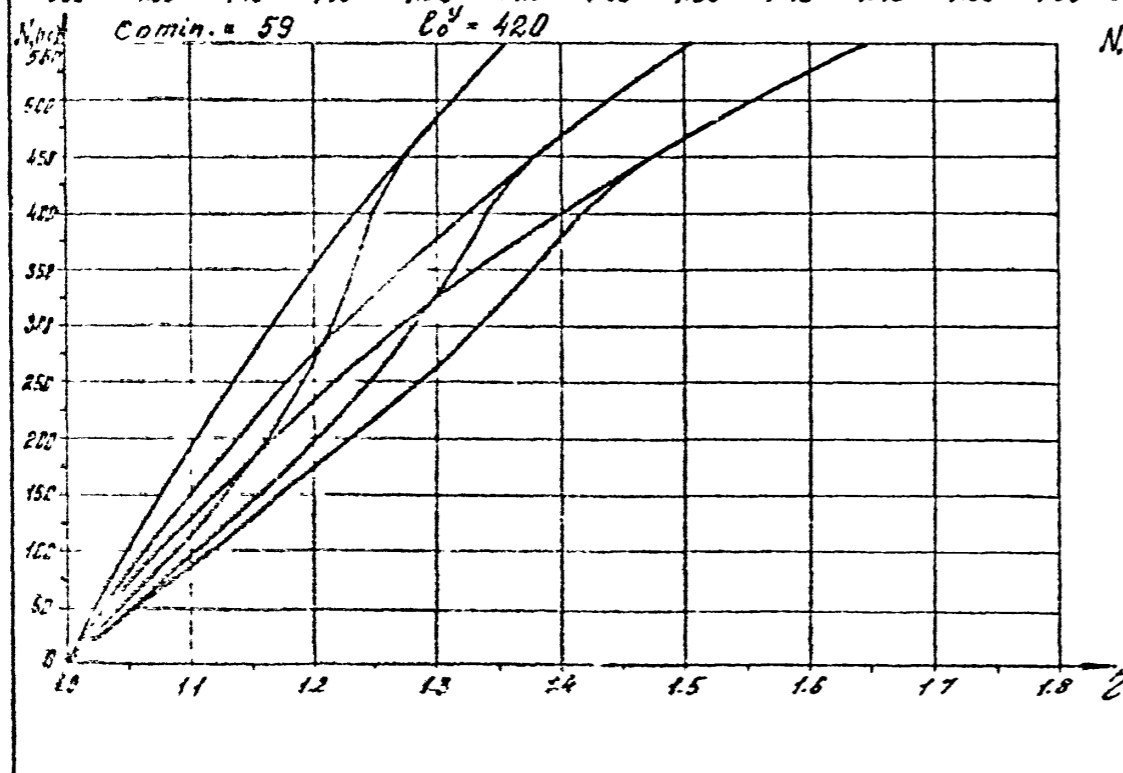
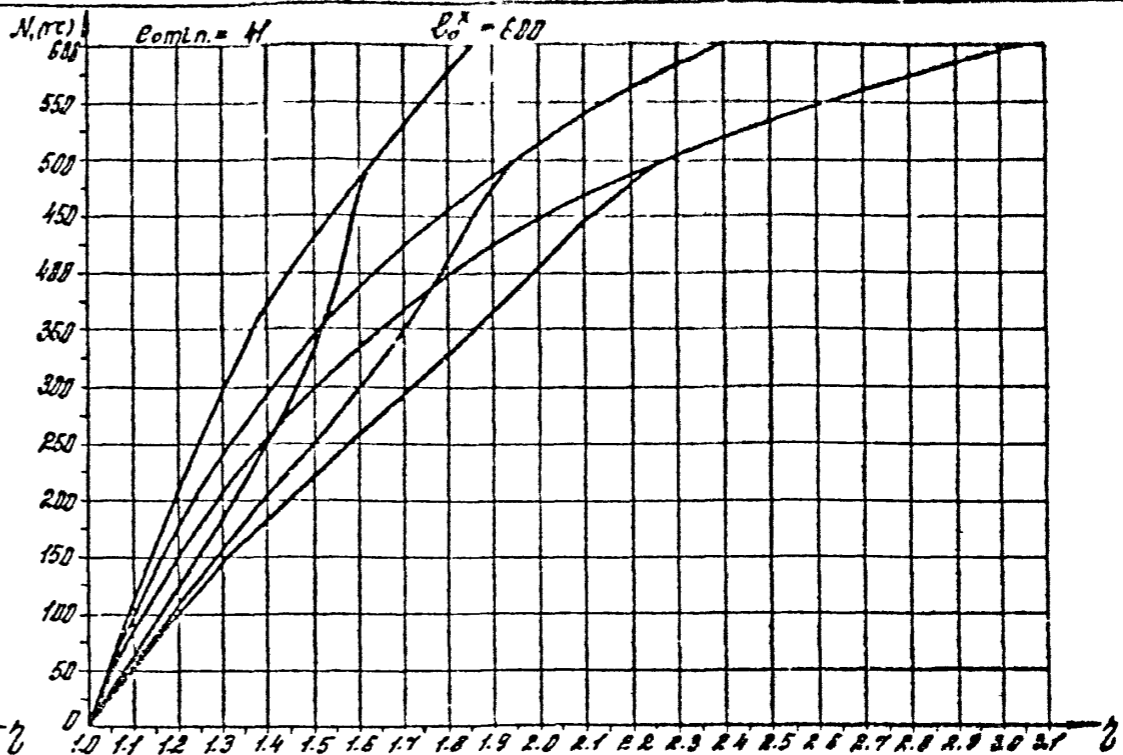
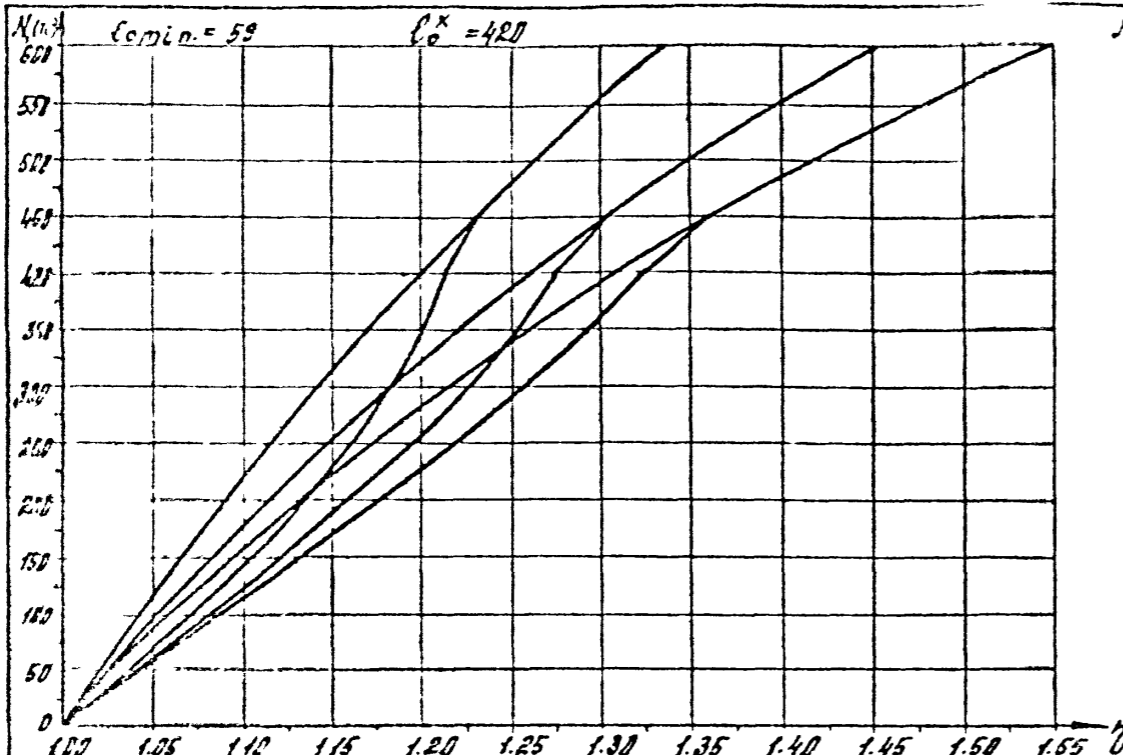

1.020-1/87. 0-8 - 3 113

AUG
114

Bx. 32829 J. 121

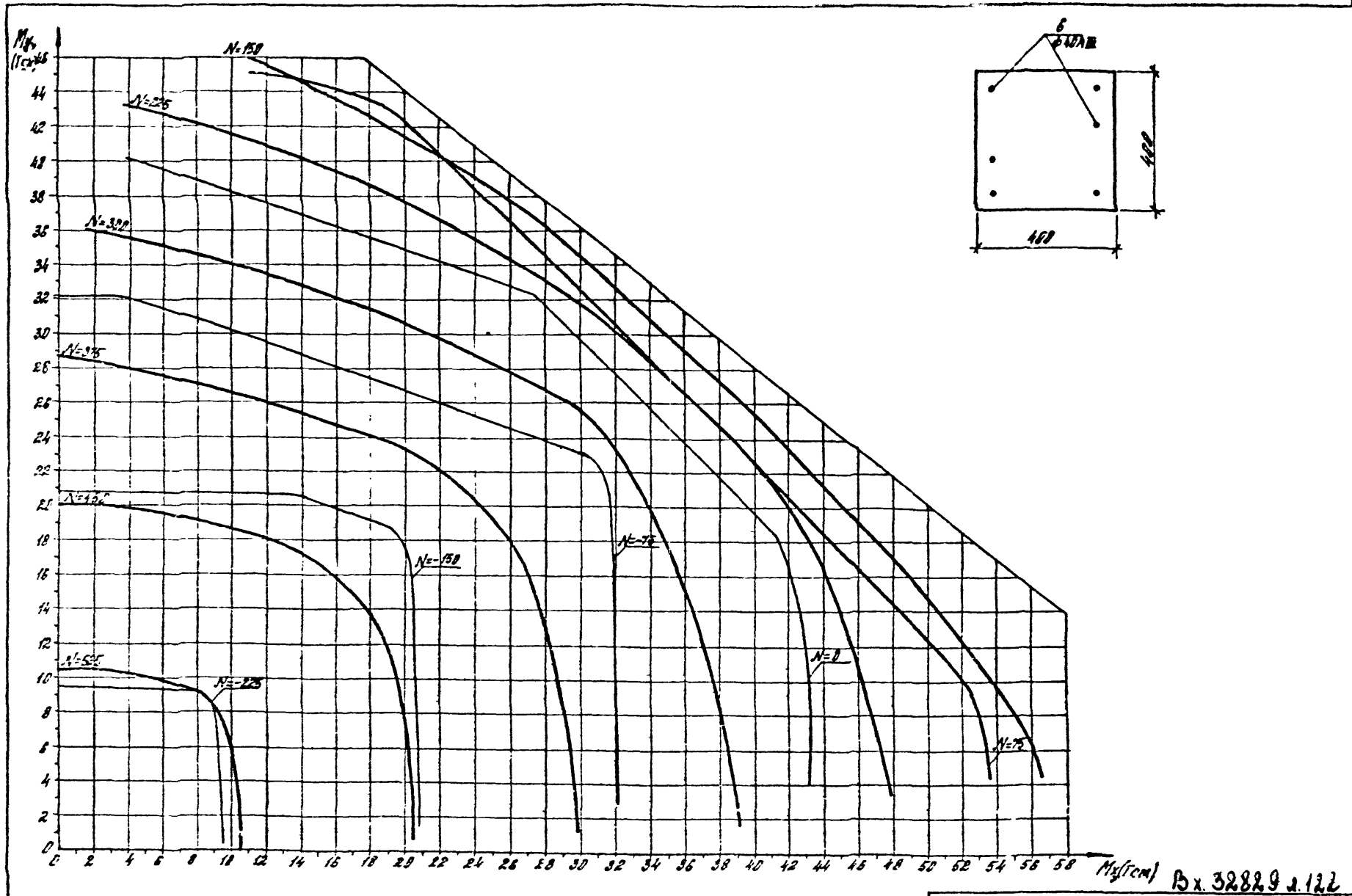

класс бетона В40 ($R_b = 201.5 \text{ кг/см}^2$ при $\gamma_{b2} = 0.9$)

1.020-1/87. 0-6-3 173 Bx. 32829 a. 122

1.020-1/87. 0-6-3 173

1027
115

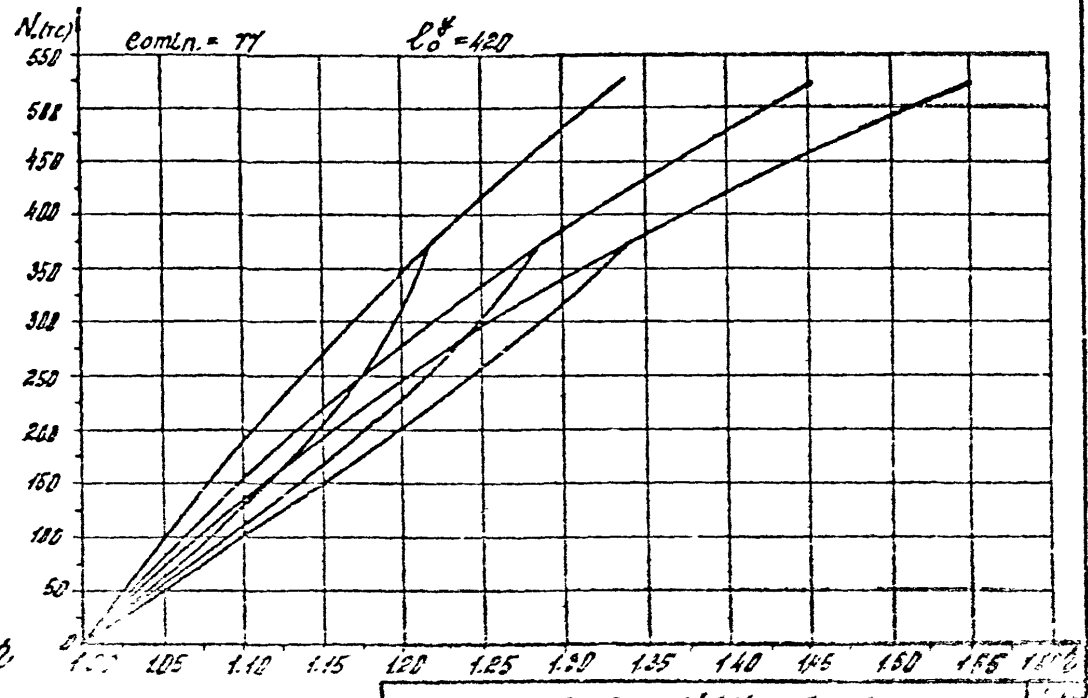
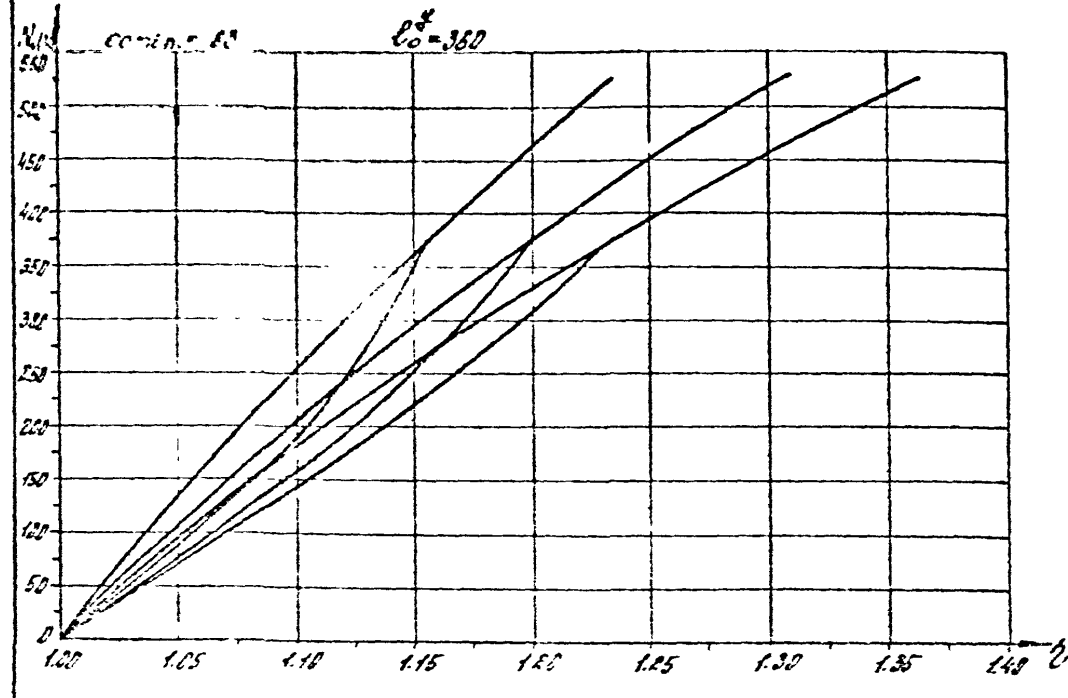
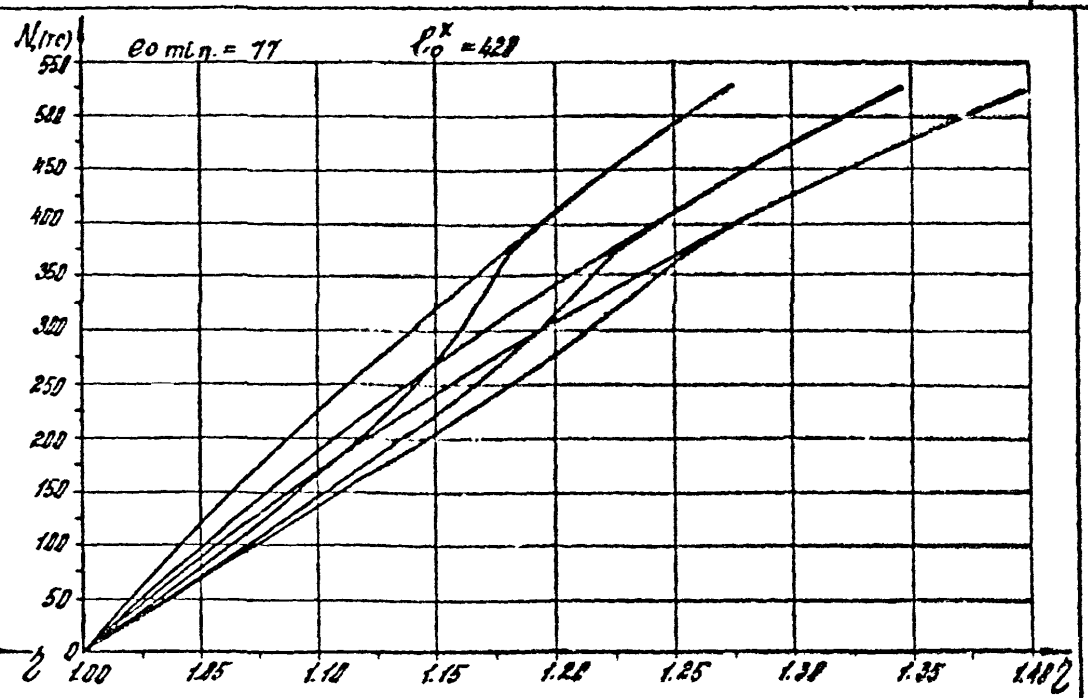
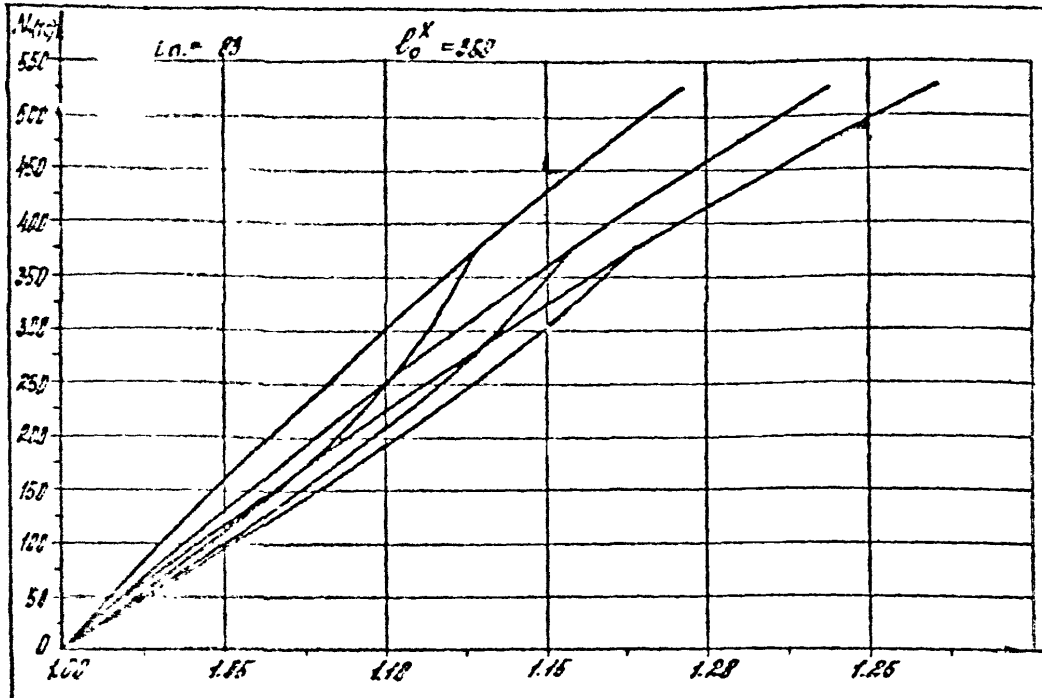

LORD. - 1/87. 0-6-3 115

Bx 32829 A-123

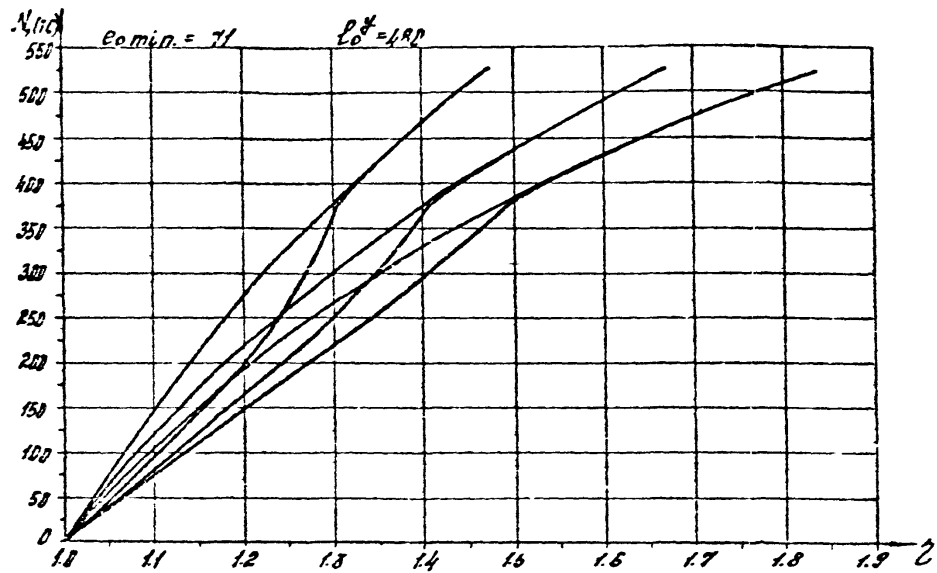
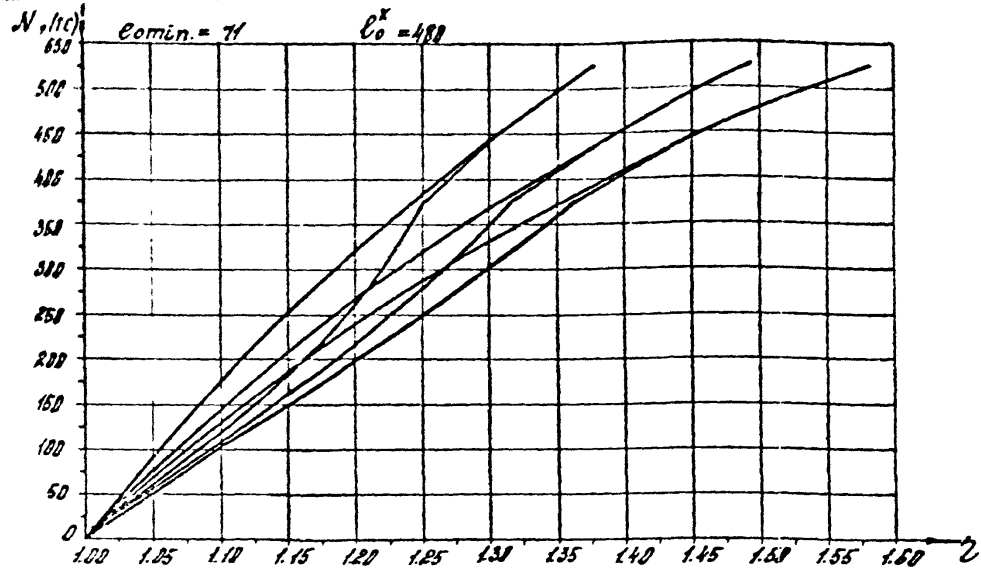

Bx. 32829 J. 124

1.020-1/87. D-6-3 173

1.020
177

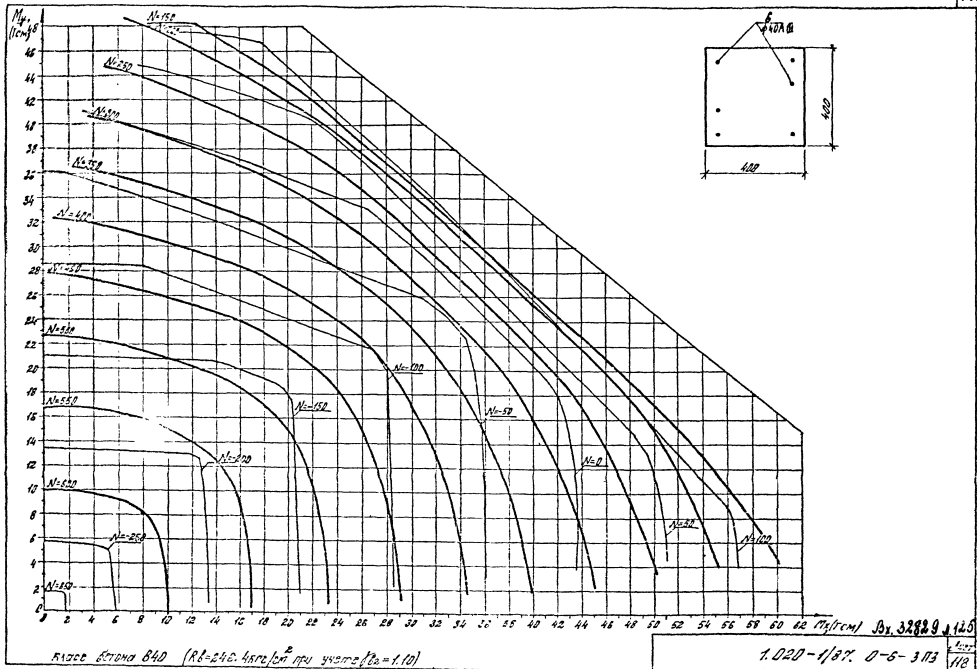

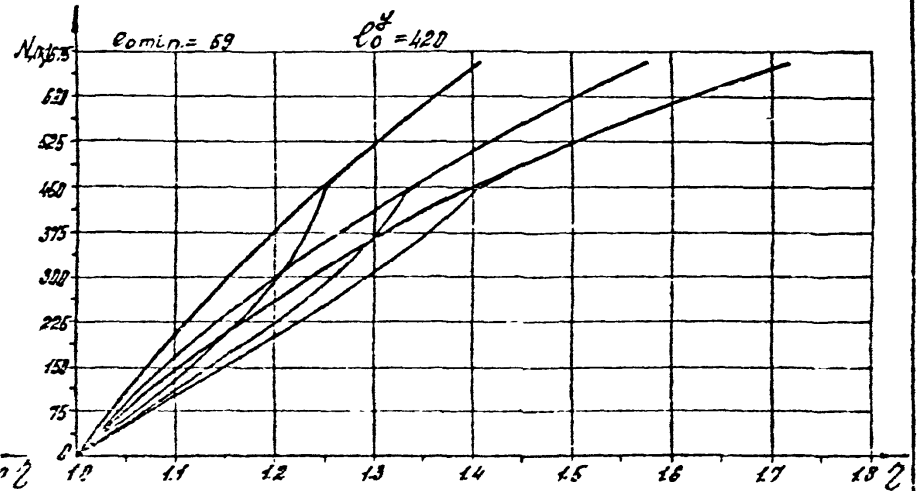
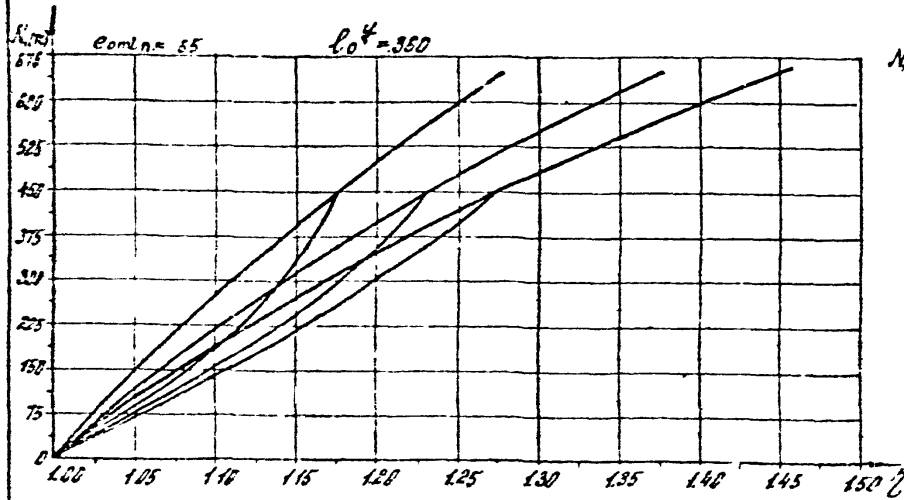
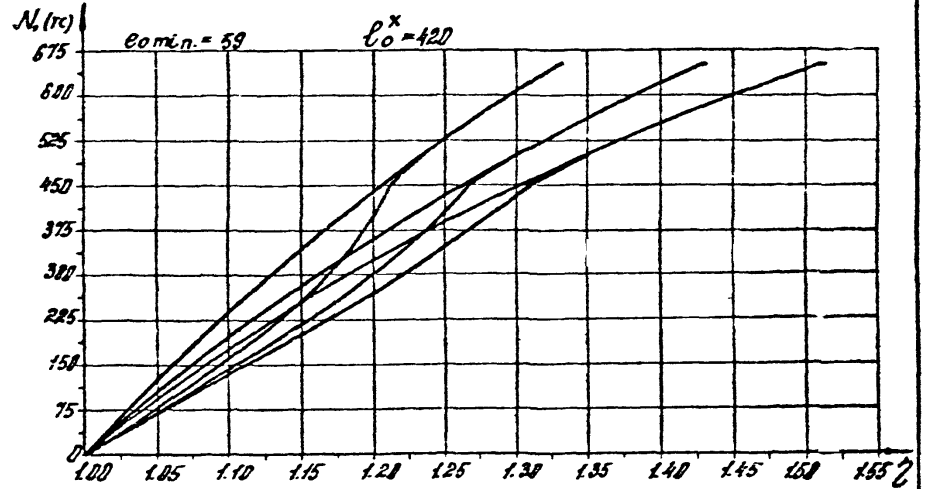
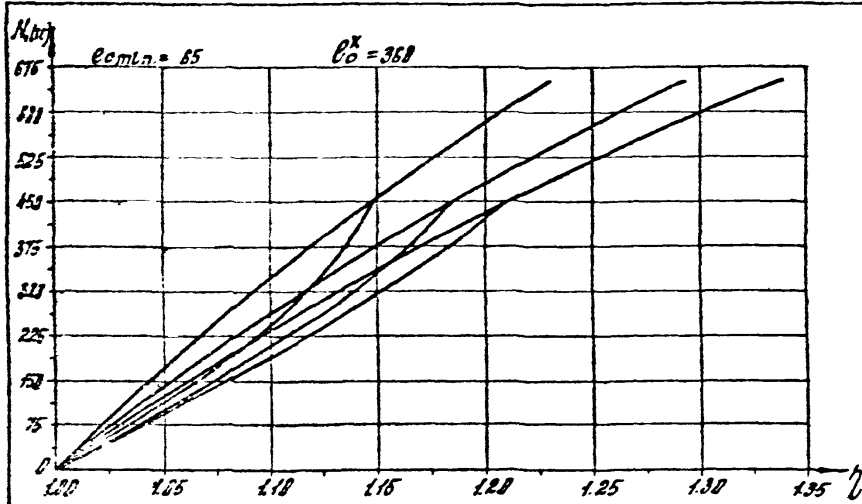

Bx 32829 a. 126

1.020-1/87. 0-6-3 113

119

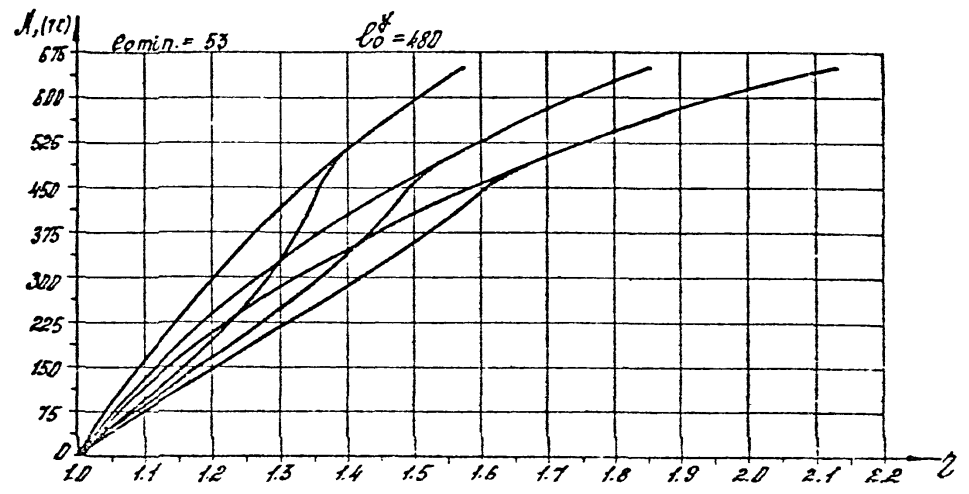
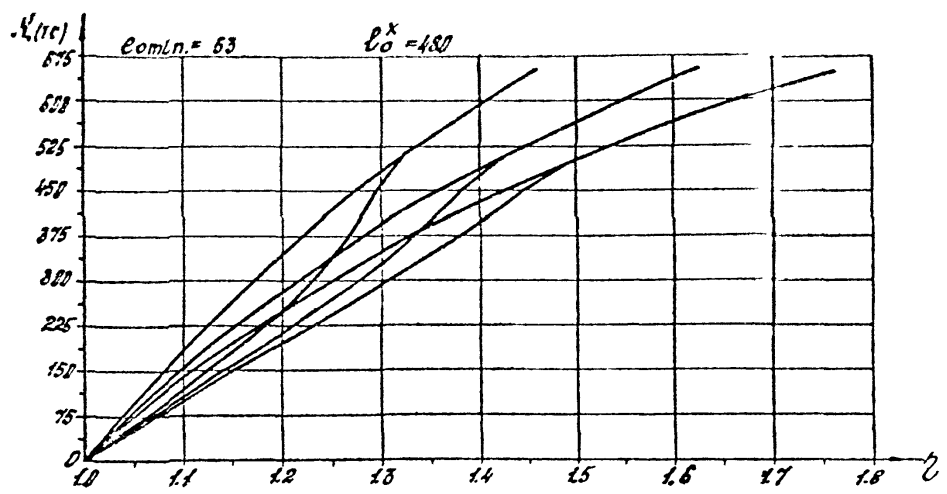

Bx. 32829 A. 127
1.020-1/87.0-5-3 175

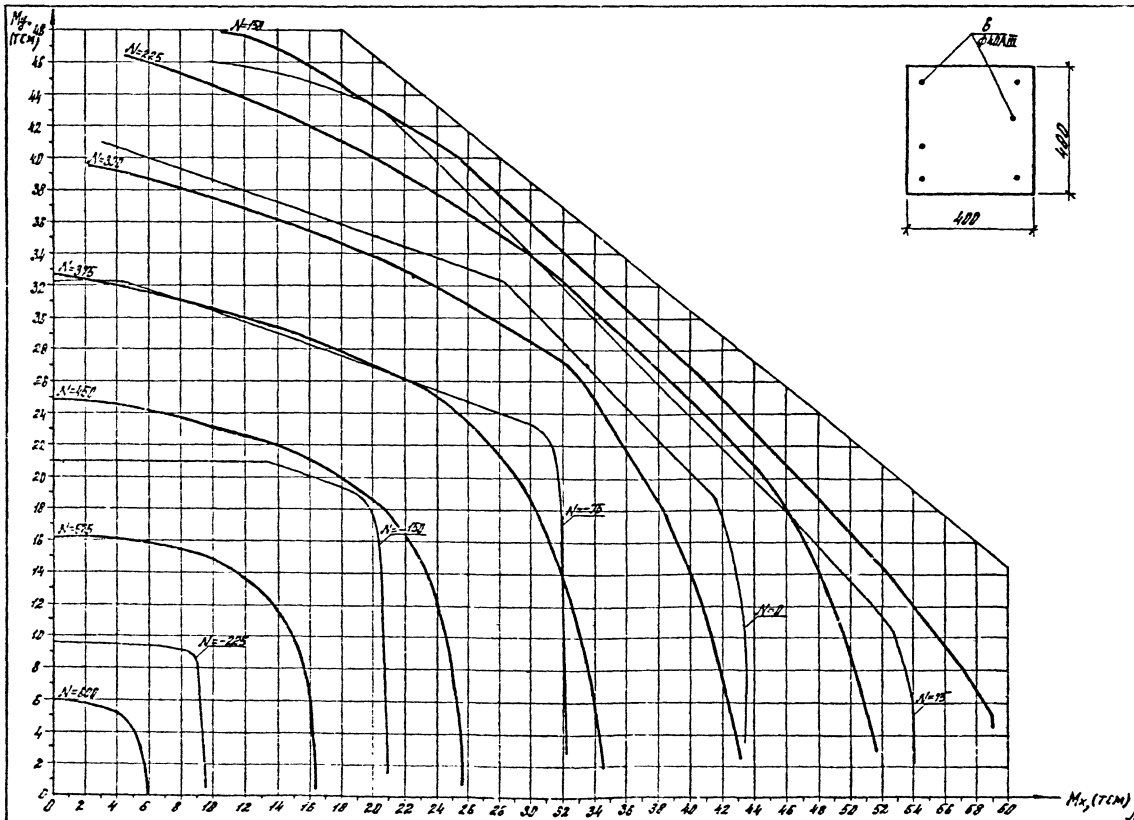

Кривые для бетона В45 ($R_b = 22.25 \text{ тс/см}^2$) при $\mu = 0.02$ ($\delta_c = 0.0$)

1020-1/87. 0-5-3173
 Ды. 32.829 и 16.8
 121

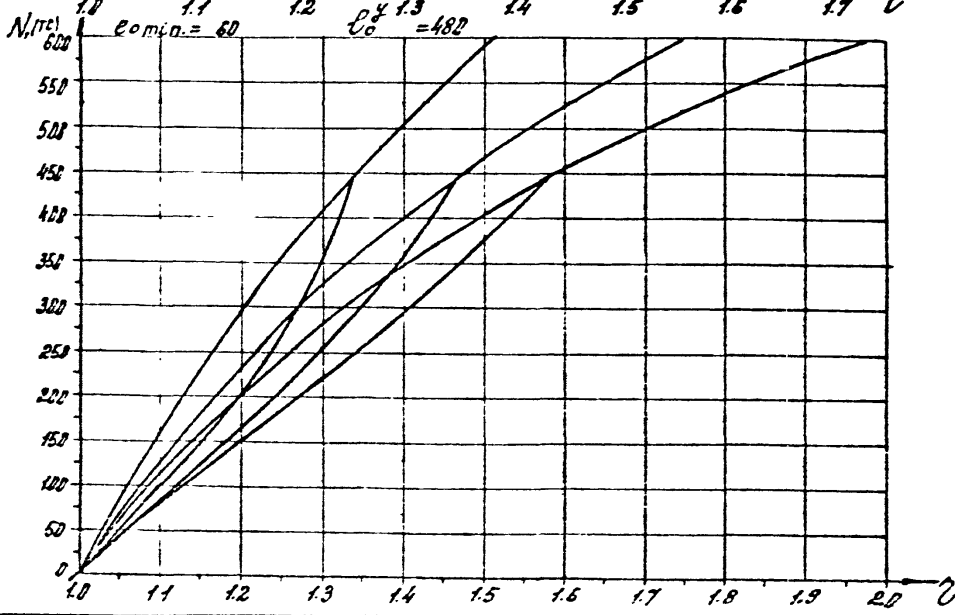
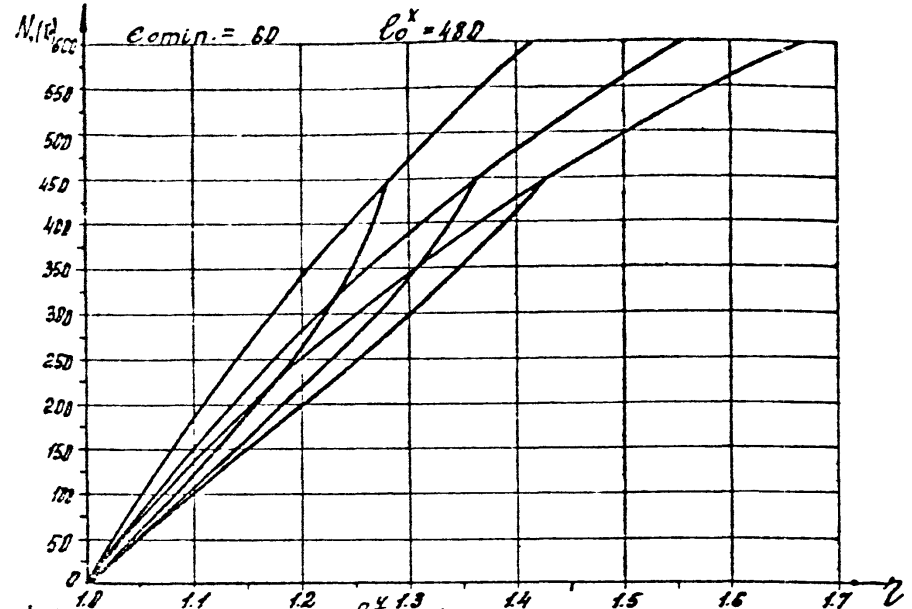

Box 32826 d. 123

LORD-1/87 0-6-3173

127
122

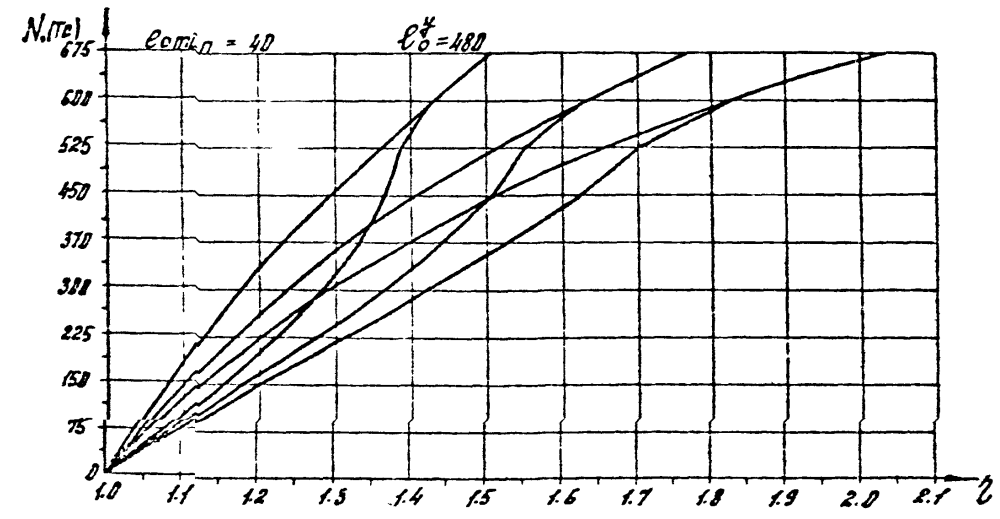
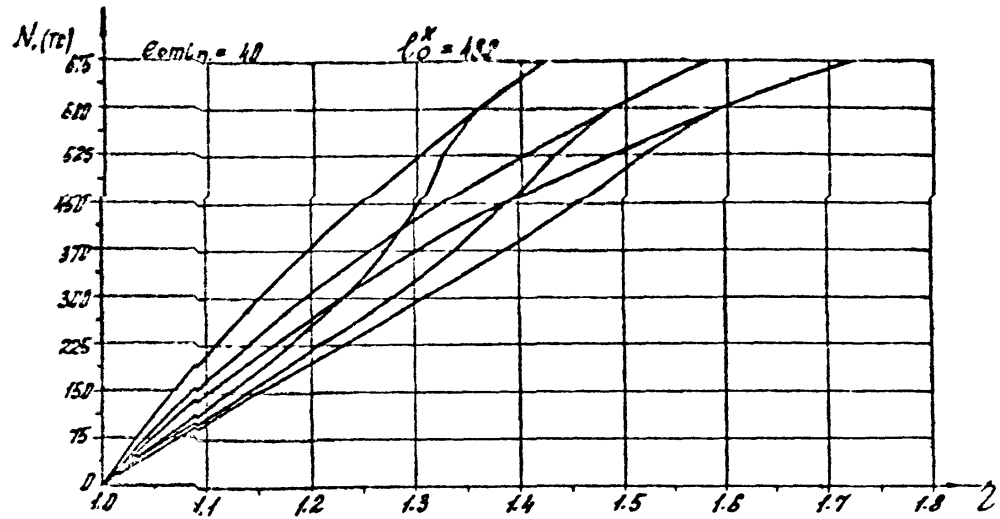

Box 32843 A. 131
1.020-1,87.0-5-3 173
Sheet 124

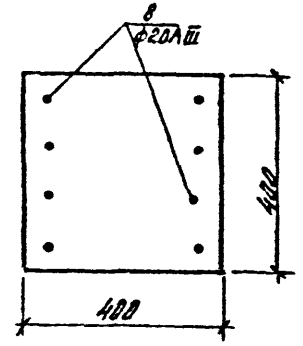
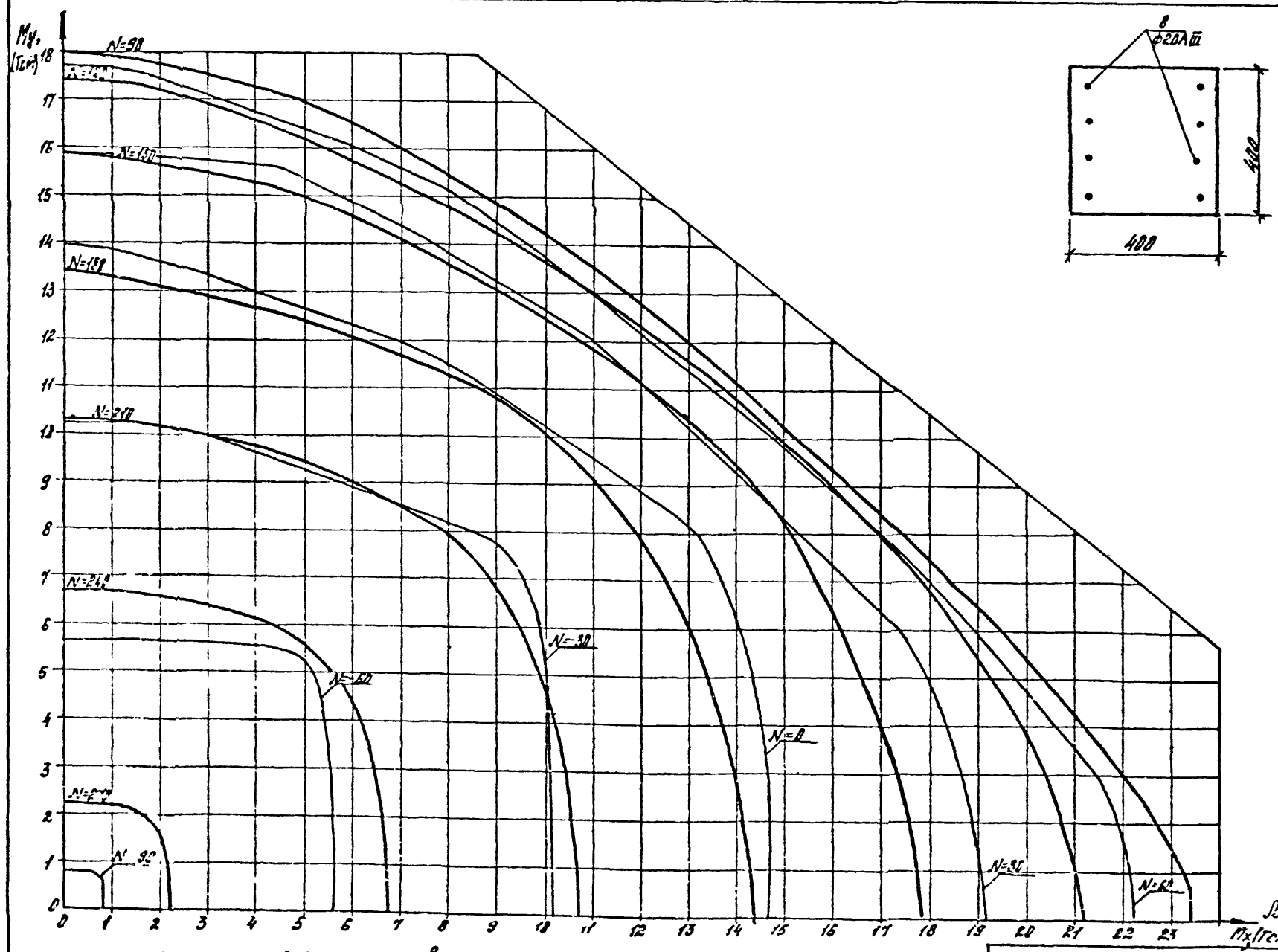

класс бетона B22,5 ($R_b = 19,2 \text{ кгс/см}^2$ при учете $\gamma_{R2} = 0,9$)

Вх 32829А.134

1.020-1/87. 0-6-313 лист 125

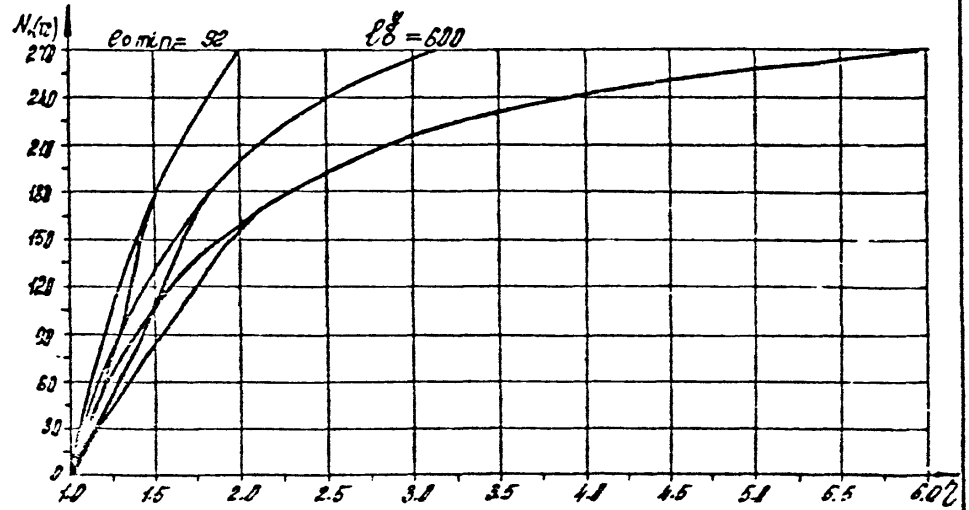
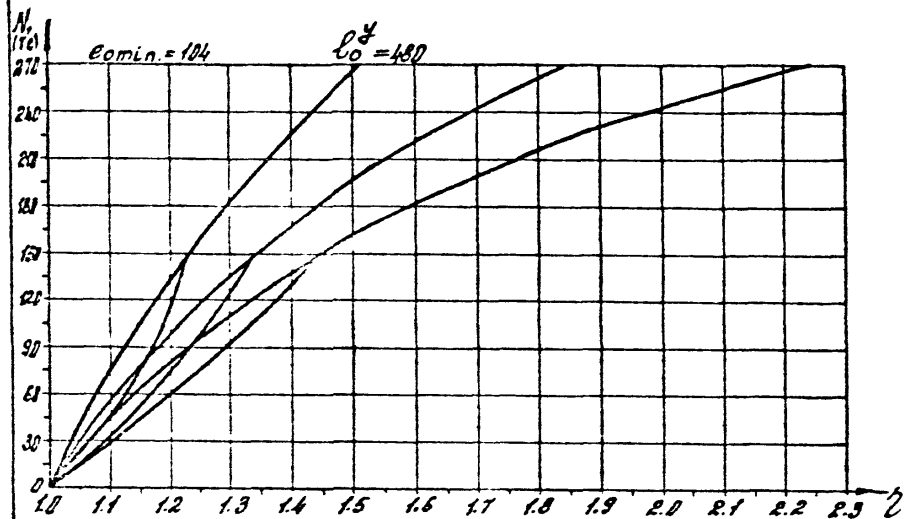
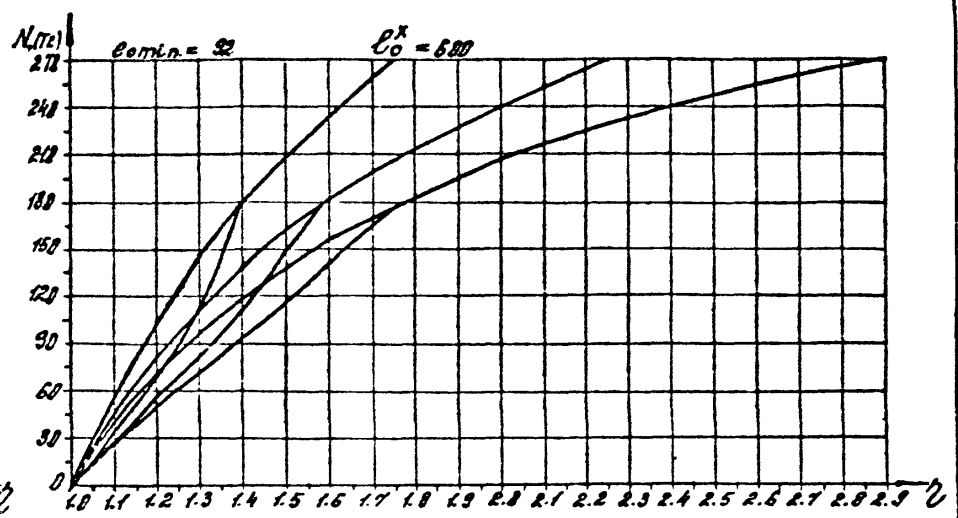
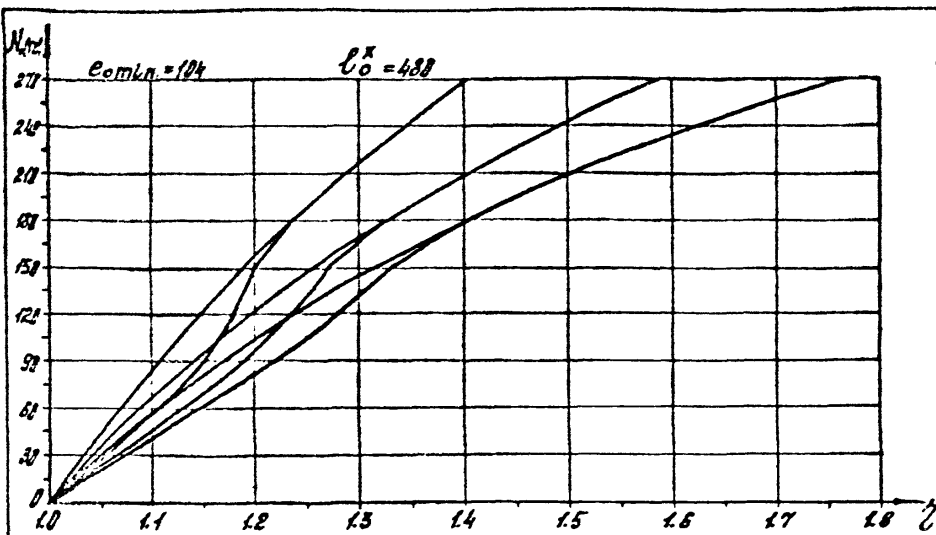

Bx. 32829 A 133

1.020-1/87. 0-6-373

127
125

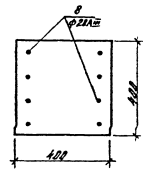
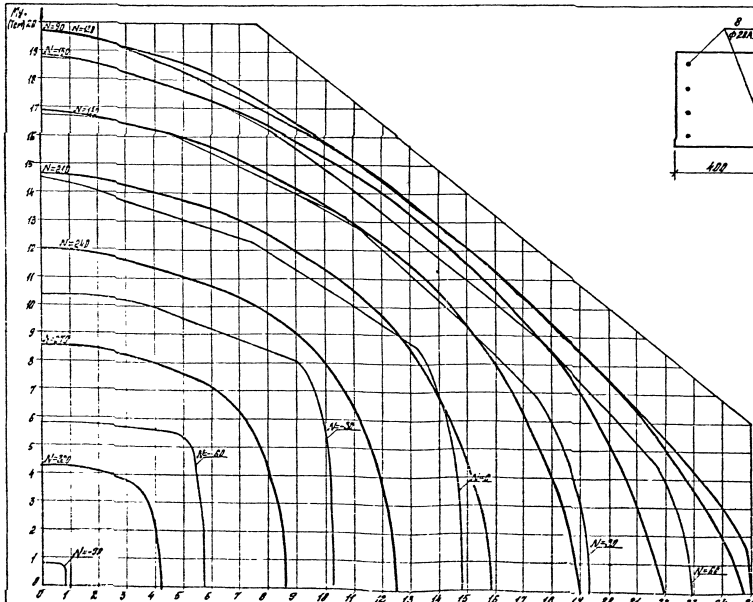

РАДНО СЪОТНОШЕНИЕ $R/R_0 = 145,76/100$ (ср. ниво $\sqrt{S_0} = 1,10$)

M_x , (rcm) $\beta_n 3282,5 \times 10^4$

1.020-1/87. 0-6-313 $\frac{1,5}{127}$

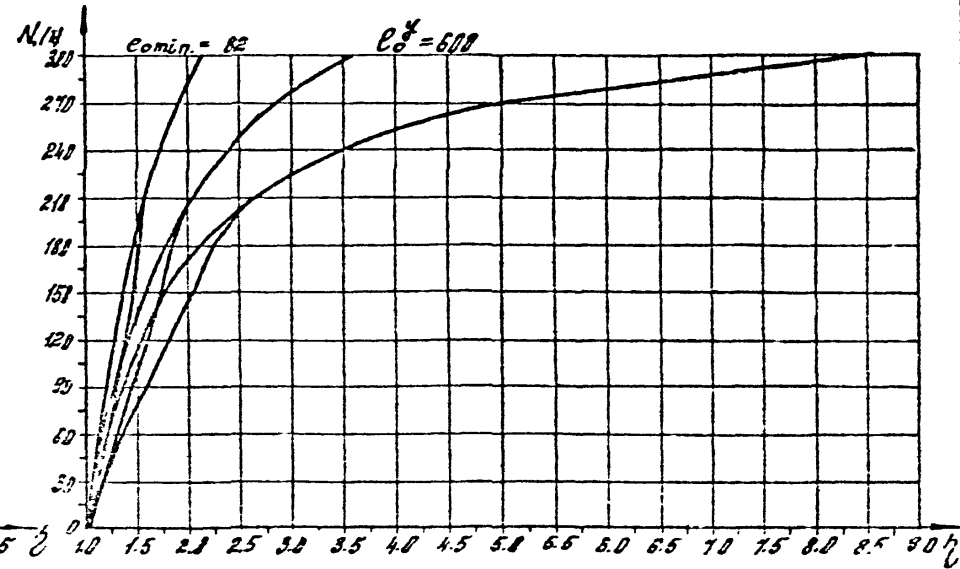
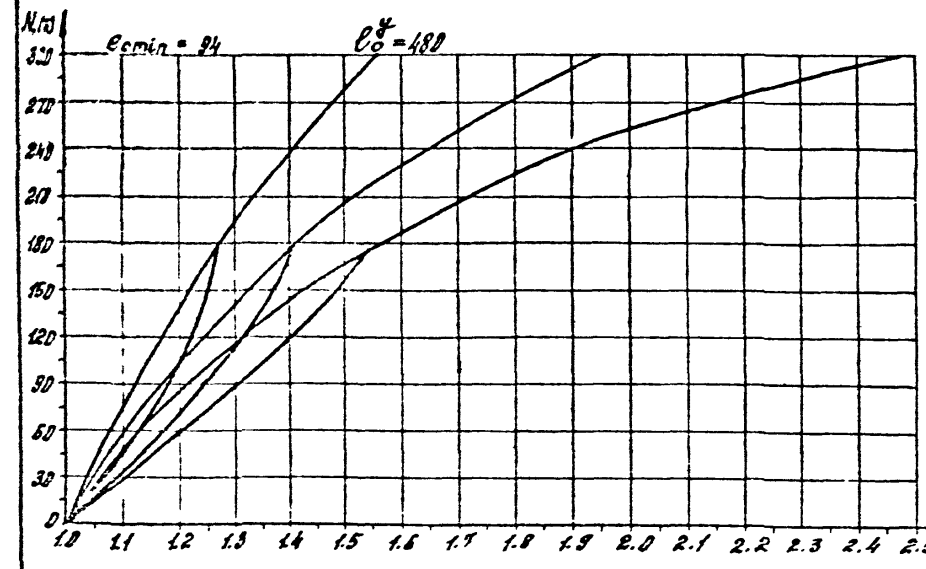
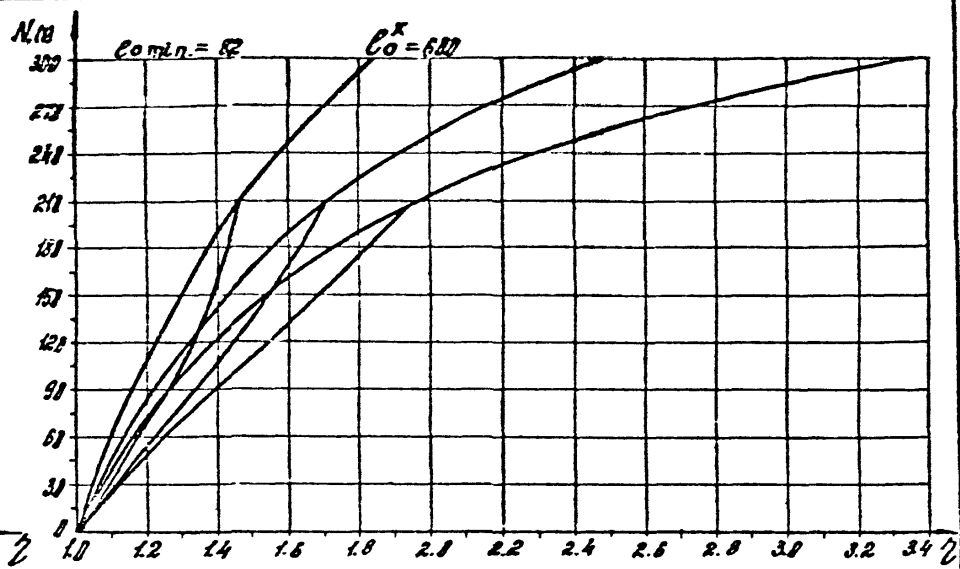
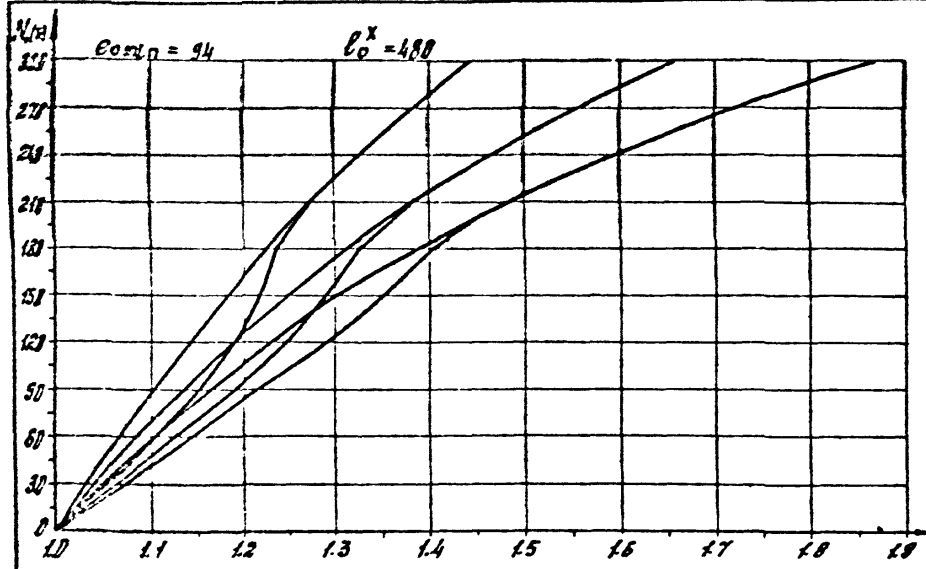

Bx. 32829 J 135

1.020-1/87.0-8-313

128

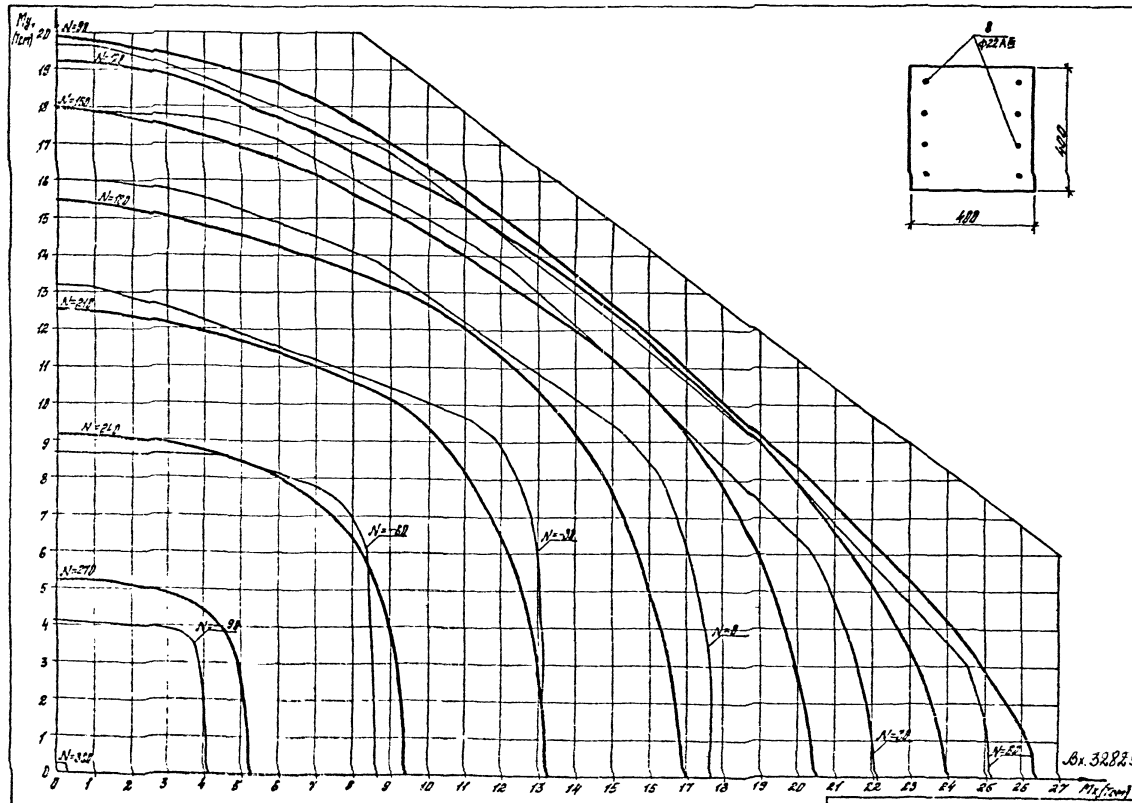

класс бетона B22,5 ($R_b = 116,2 \text{ МПа}$) при $\lambda_{\text{ср}} = 0,01$

1.020-1/87.0-6-3/3

Лн. 32829 А.136

Лист
12.9

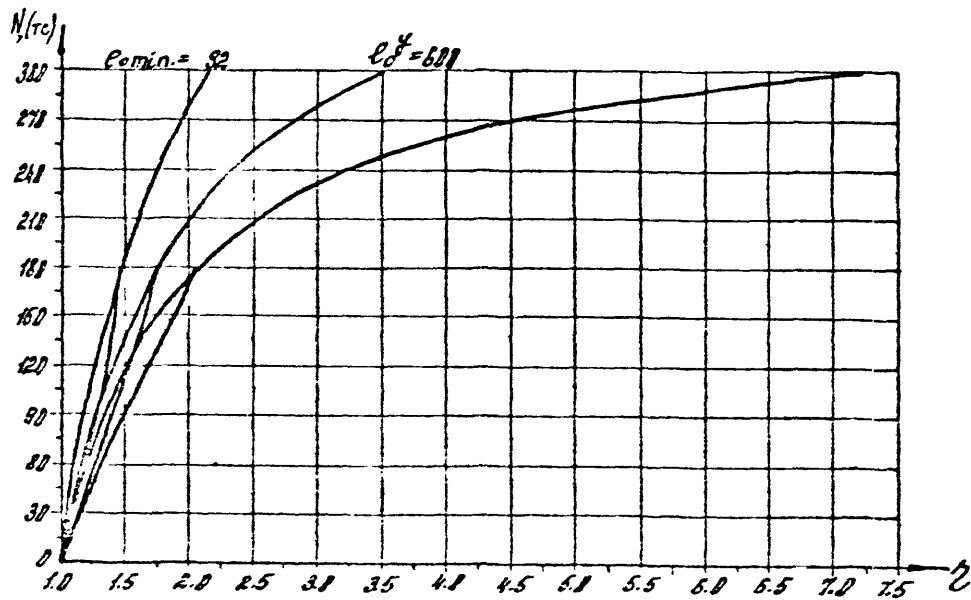
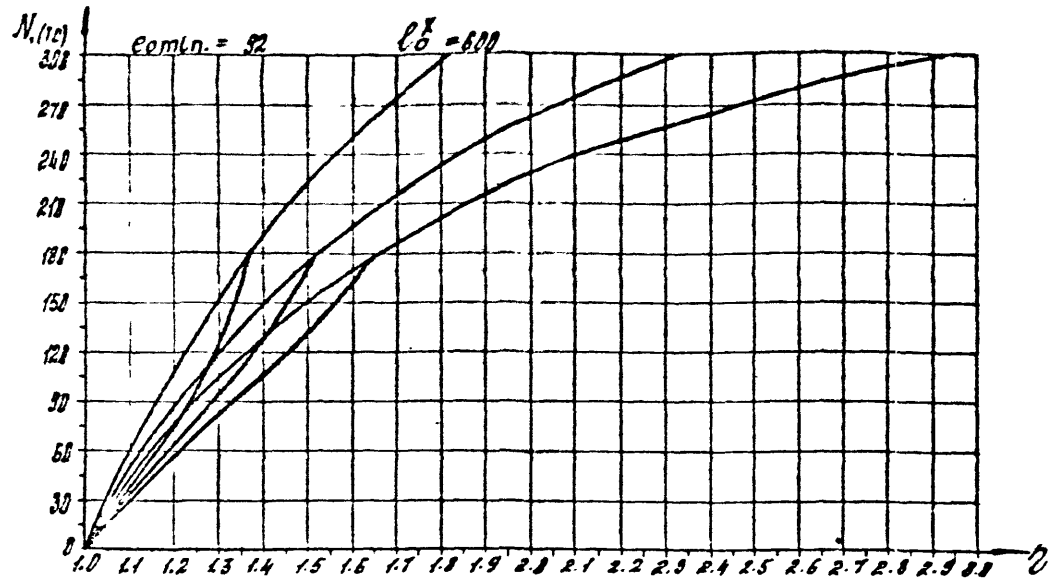

22X. 52343 A. 107

1020-1/27. 0-6-313

130

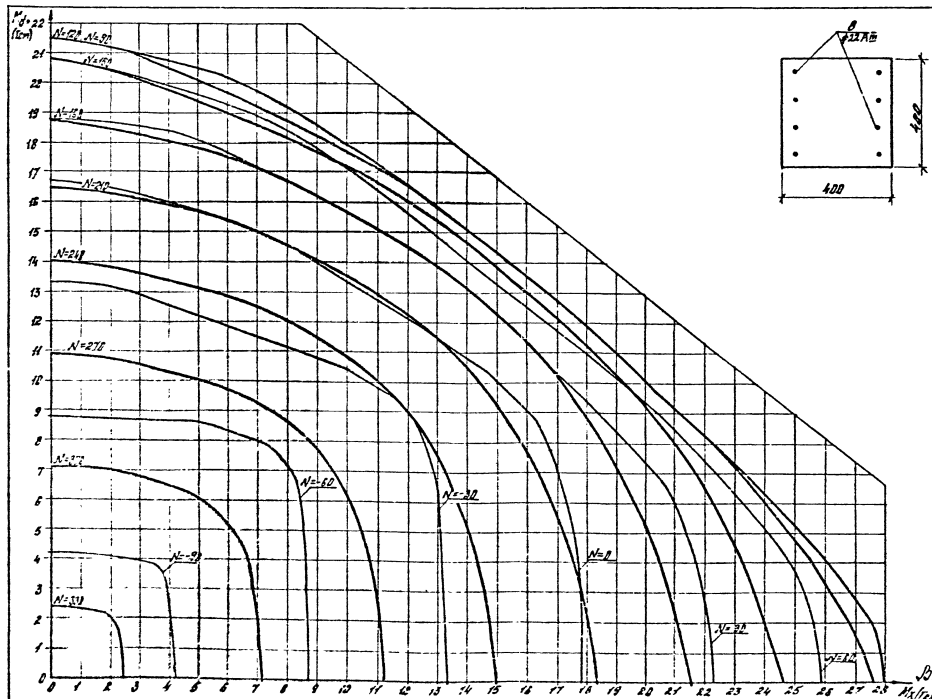

класс бетона B22.5 ($R_B = 145 \text{ MPa}$) при $\gamma_{\text{ср}} = 1.10$

Дж. 32829 д. 10

1.020-1/87.0-6-303

1/11

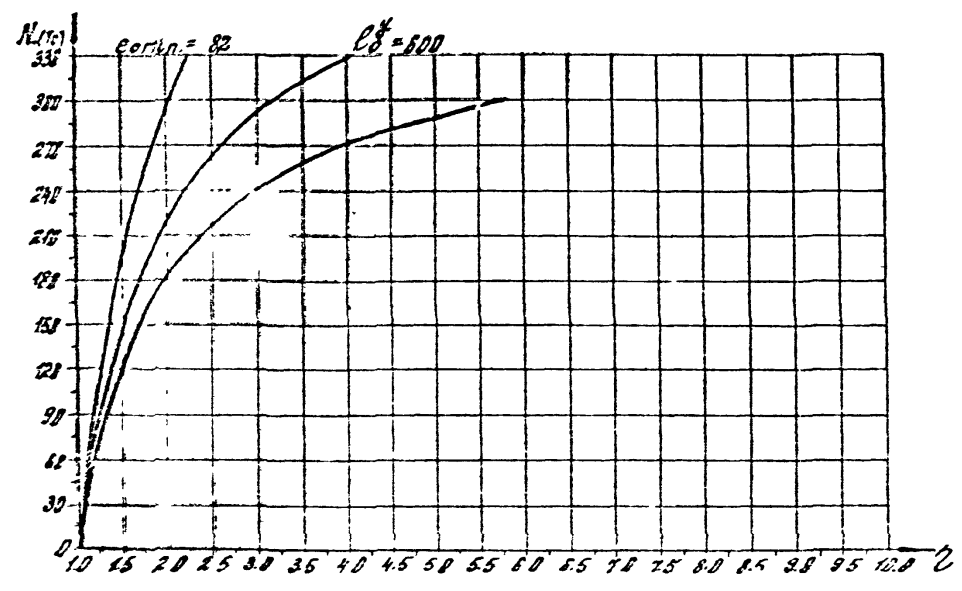
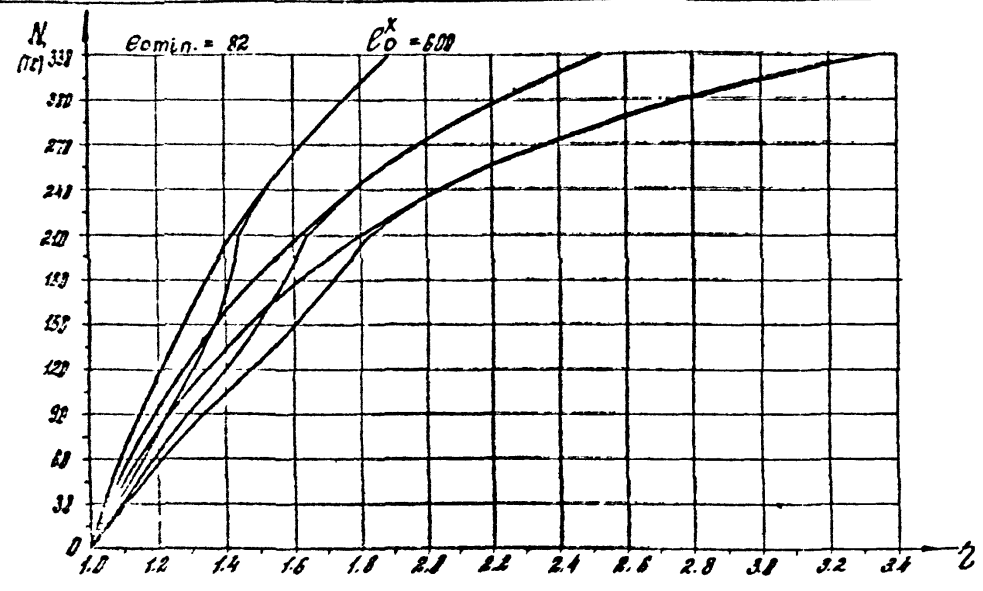

Bx. 32829 A. 139

1.020-1187. 0-6- 303

132

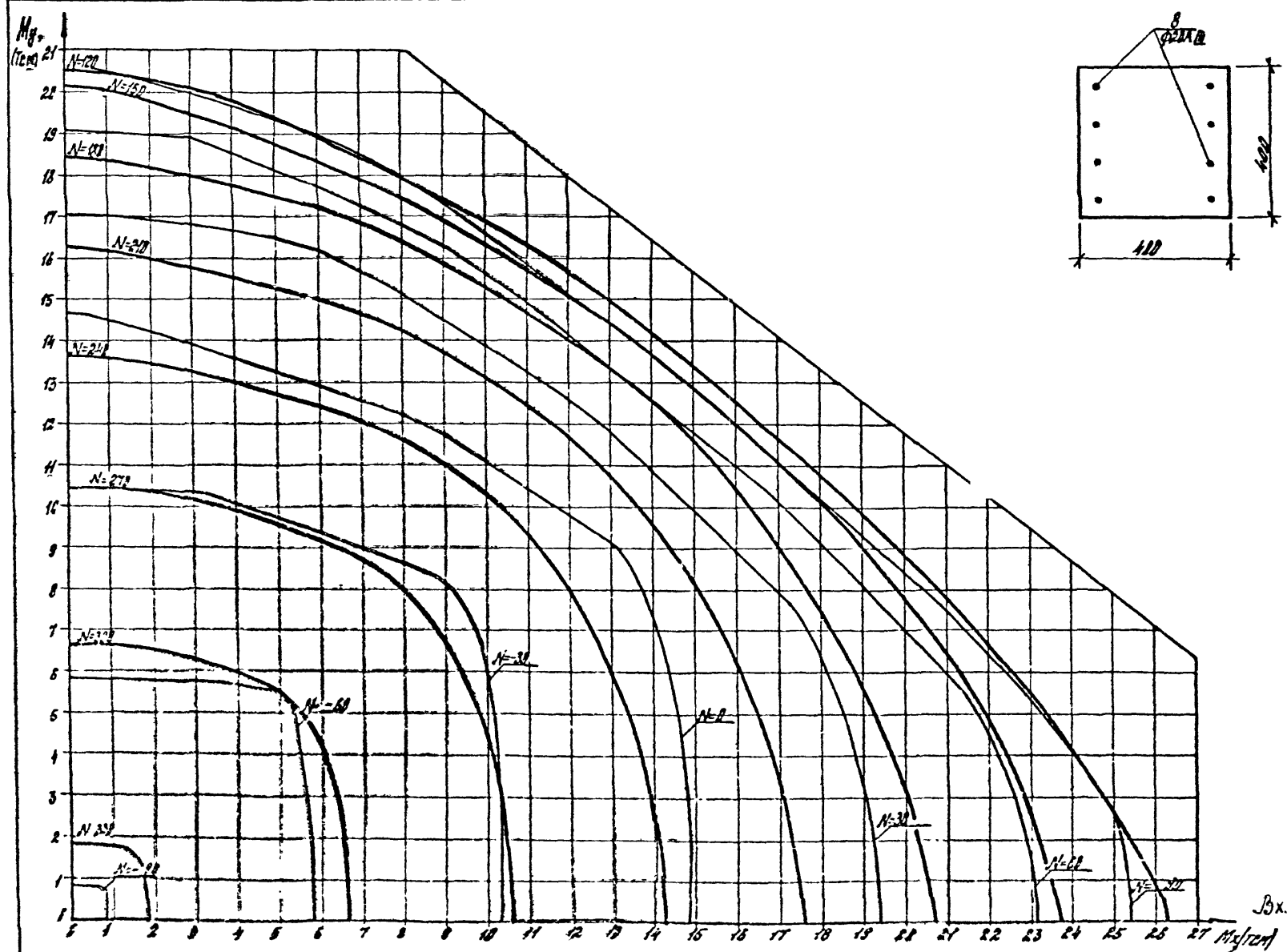

Bx. 32829 A. 140

РАССЧ. СЕЧЕНИЯ В30 (R_B = 155. МПа/см² при $\sigma_{ср} = 0.9$)

1.020-1/87.0-6-313

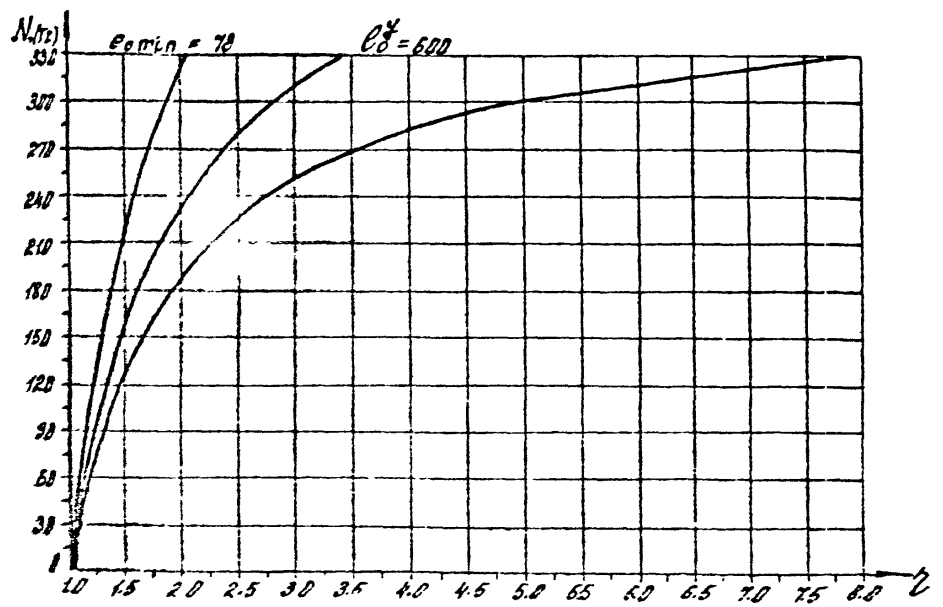
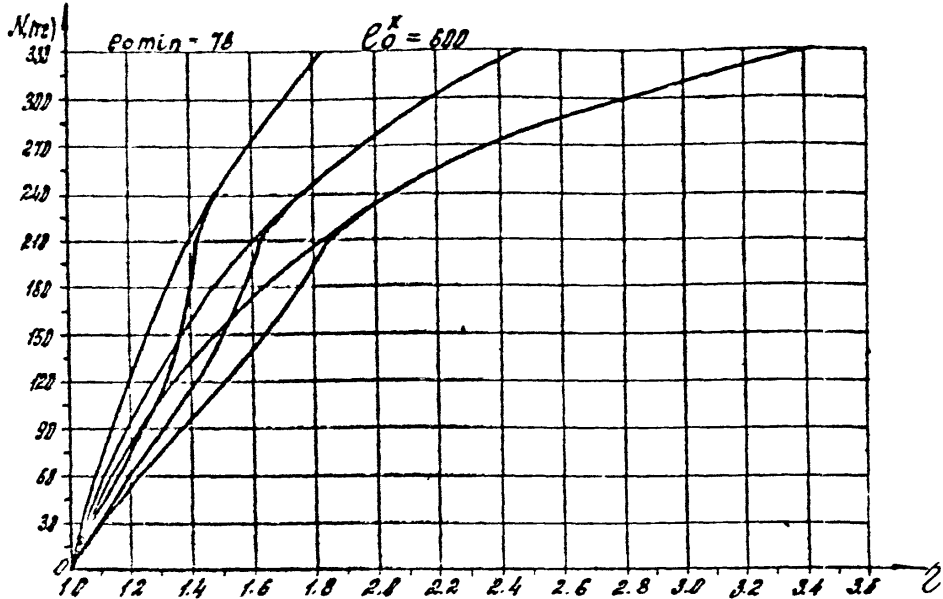

Ex. 3282 + A. 141
1.020-1/87. D-6-373

1.027
139

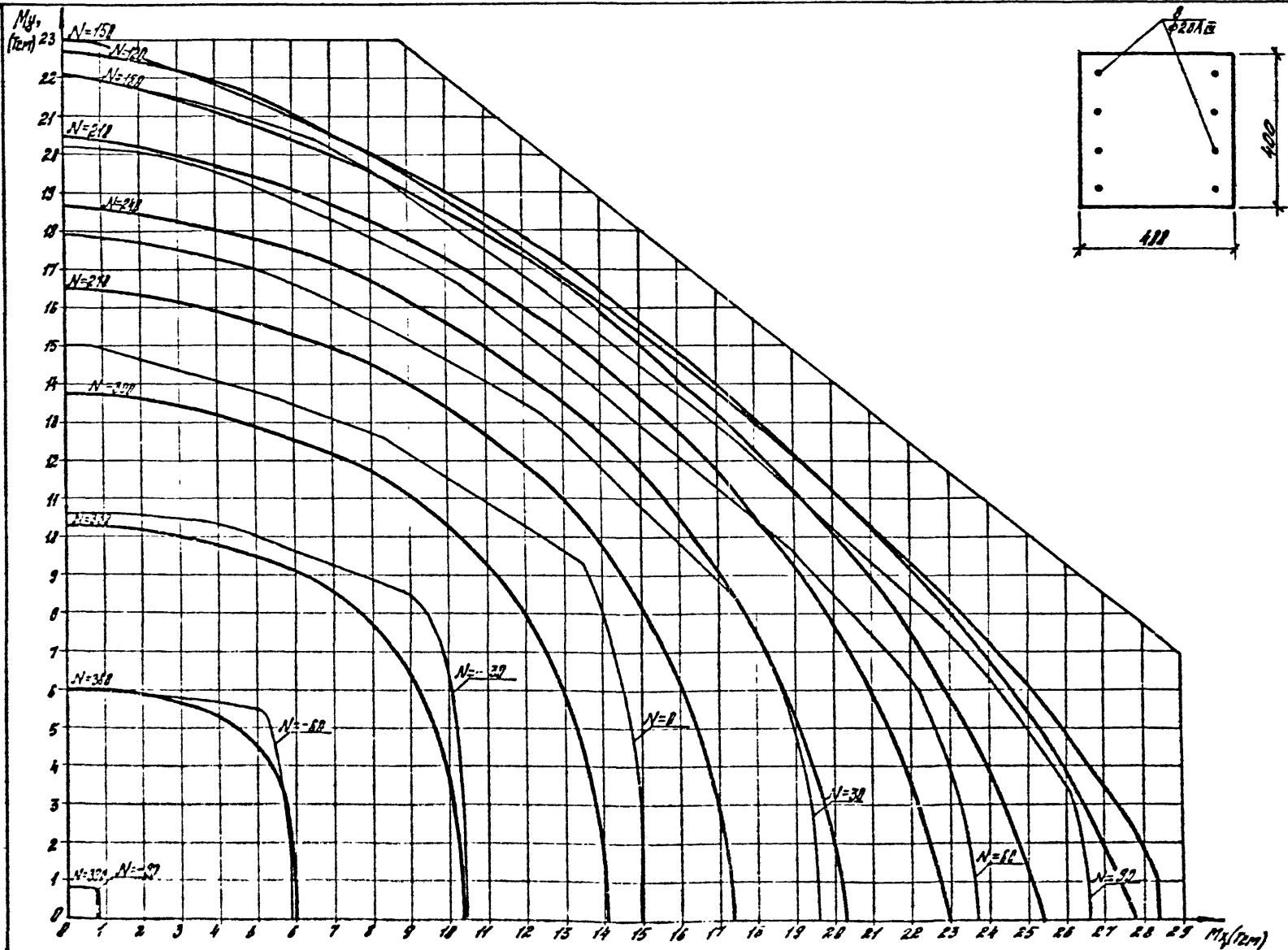

класс бетона В30 ($R_b = 19.23 \text{ кгс/см}^2$) прутья - е ($f_b = 1.10$)

Вх. 32829 г. 14г.

1.020-1/87. 0-6 - 3 173		1.020
		135

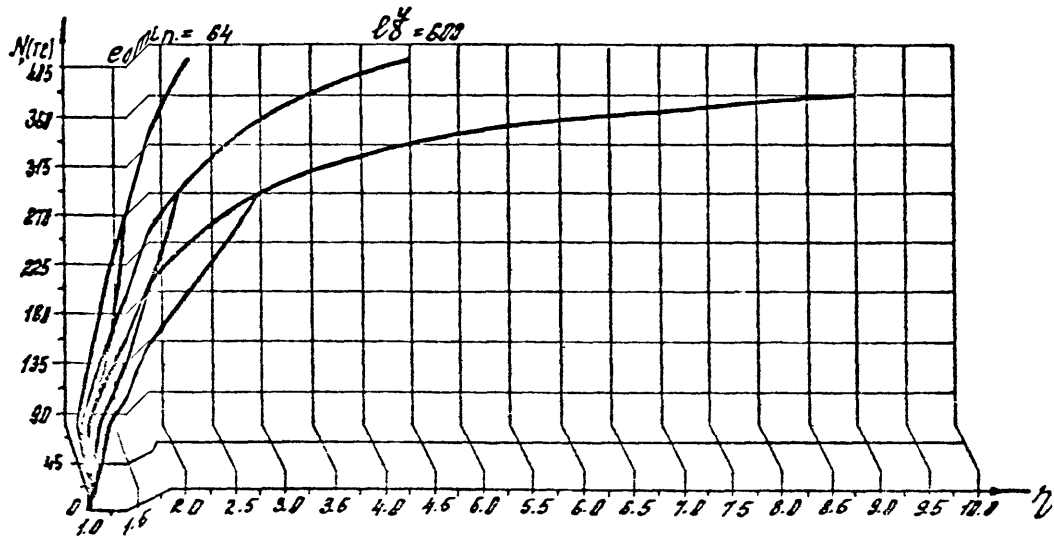
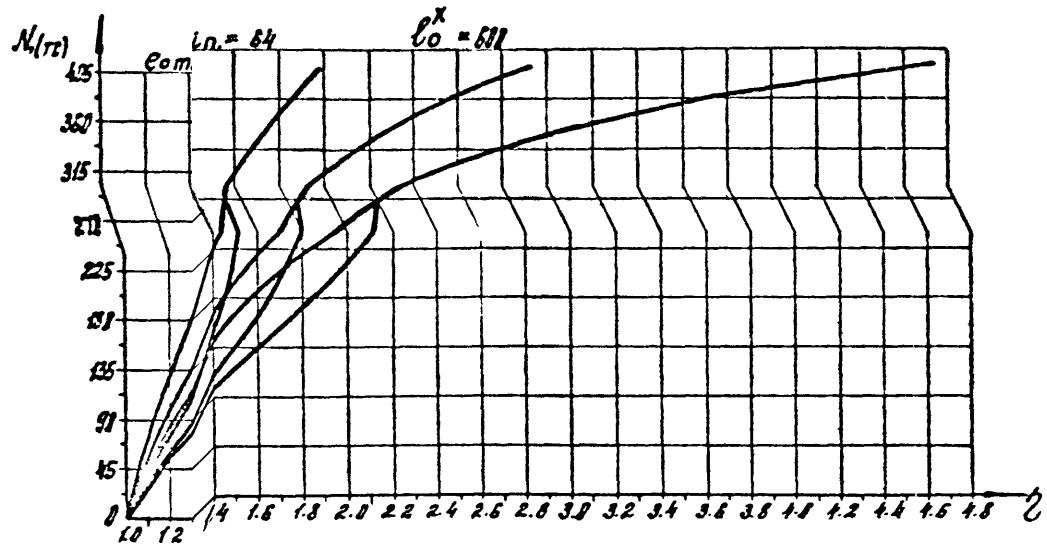

Ba. 32829 A. 143

1.020-1/87. 0-6-3113

136

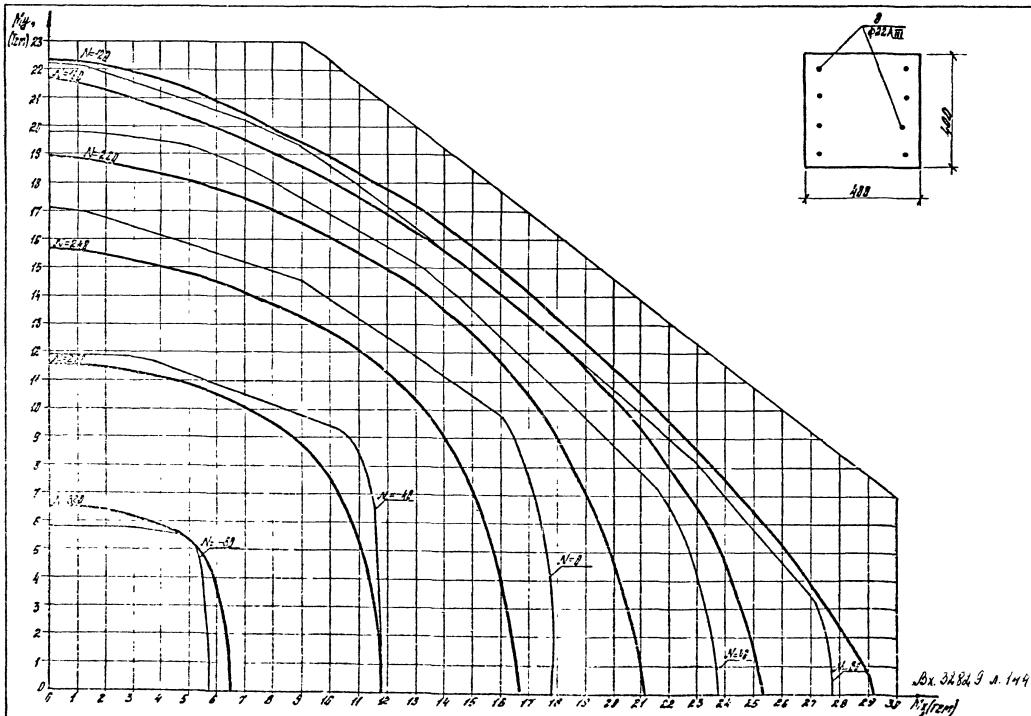

плоск. бетона В30 ($R_b = 155,7 \text{ кг/см}^2$ при учете $\gamma_{R2} = 0,9$)

1.020. - 1/87. 0-6-3/13

107

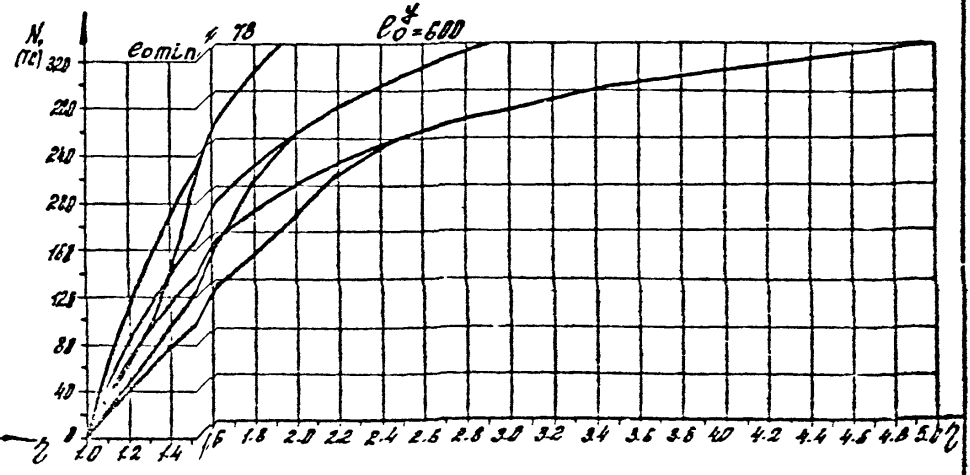
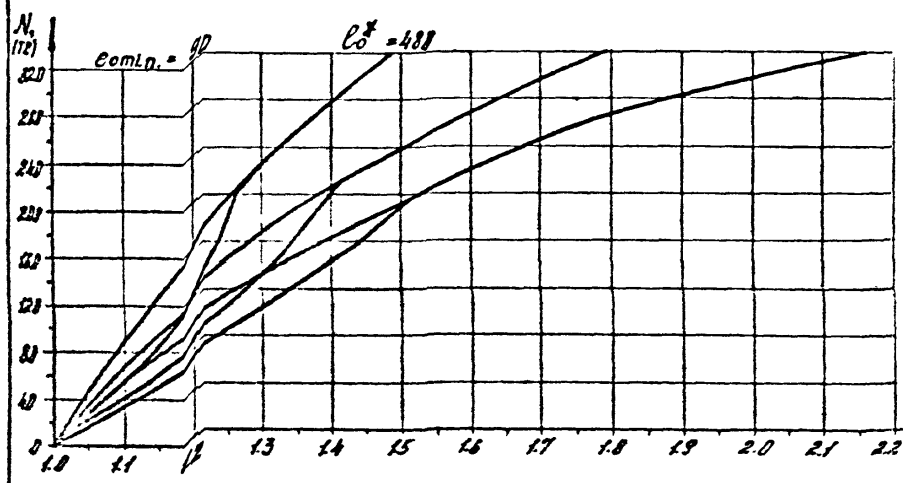
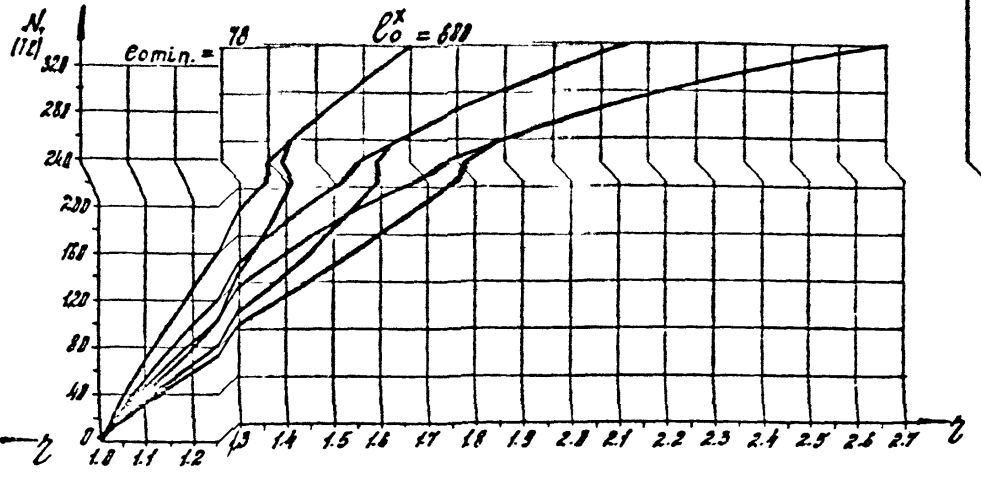
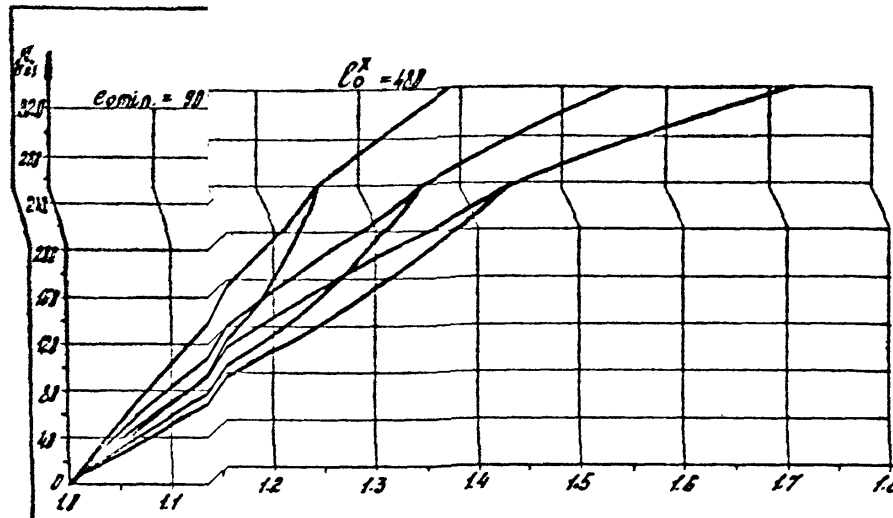

50x 32829 1.145

1020-1/87. 0-5-3 113

157
158

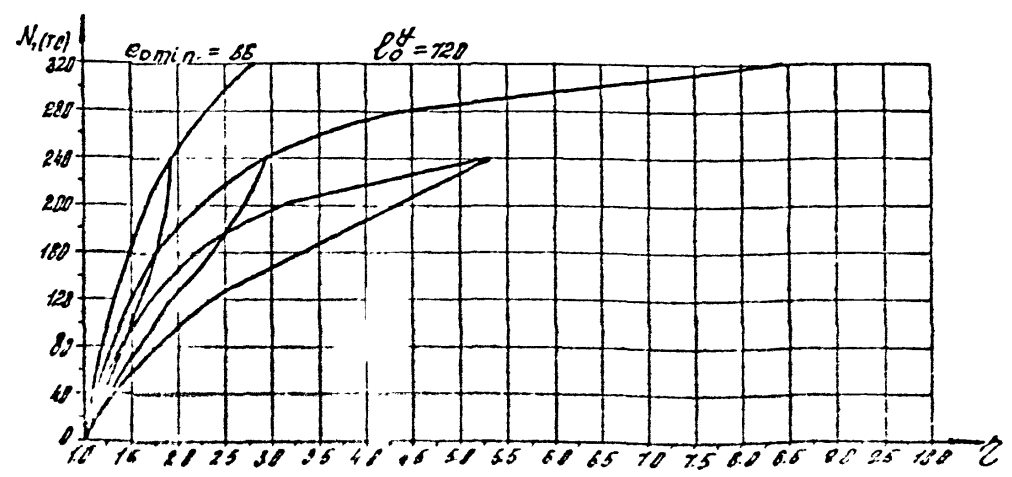
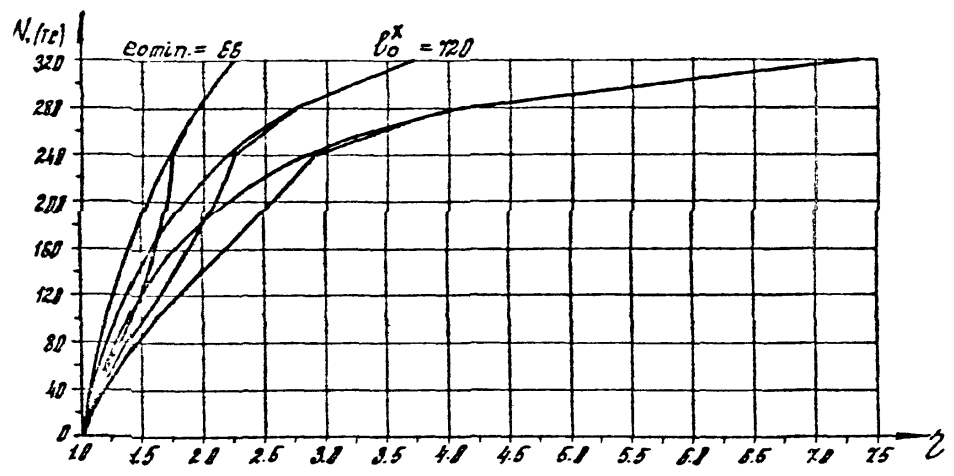

Bx. 32829 A. 146

1.020-1/87. 0-6-3 173

139

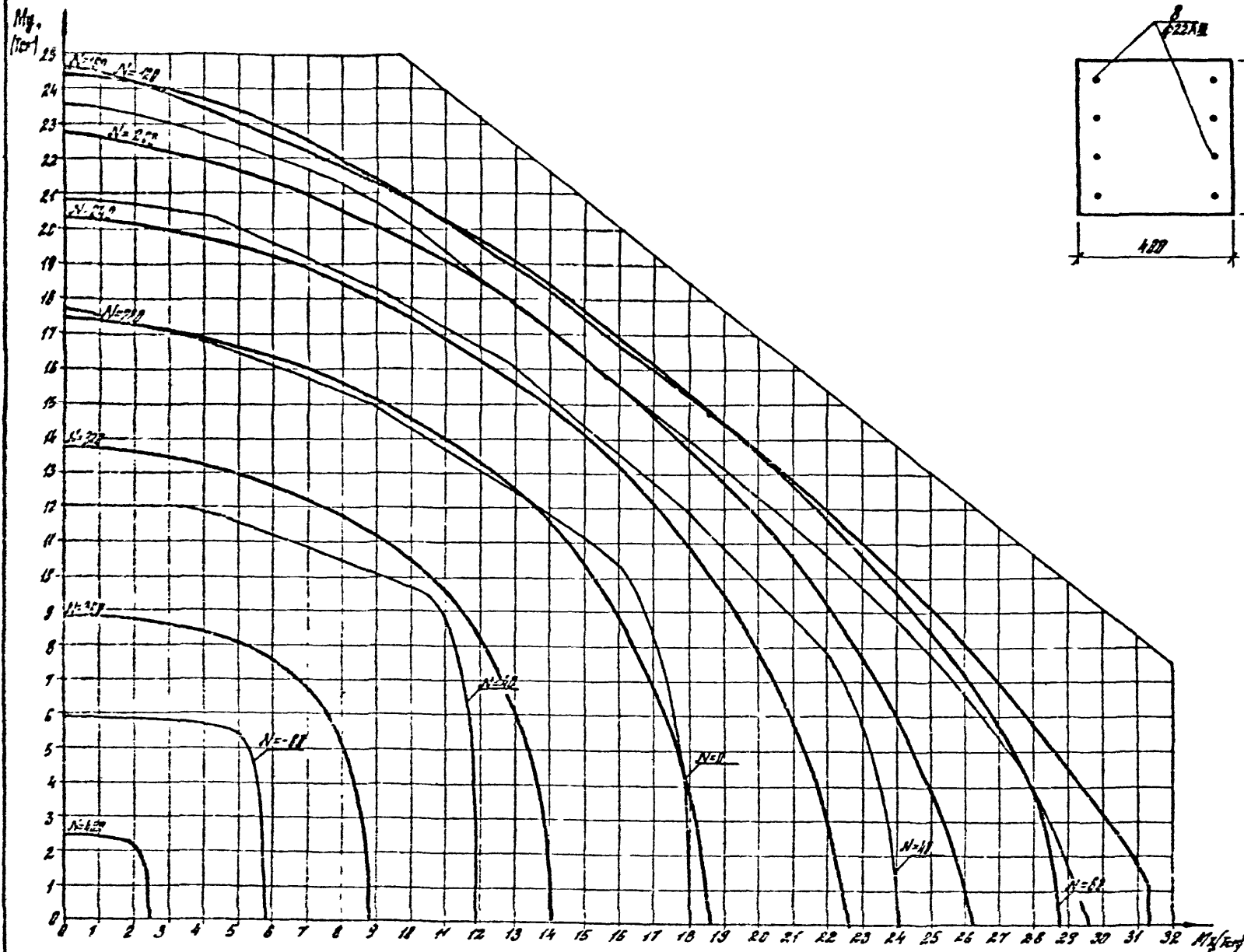

Бх. 32820 А. 147

класс бетона B30 ($R_b = 130.3 \text{ Н/мм}^2$ при учете ($\gamma_c = 1.10$))

1.020-1/87.0-6-373 1/22
110

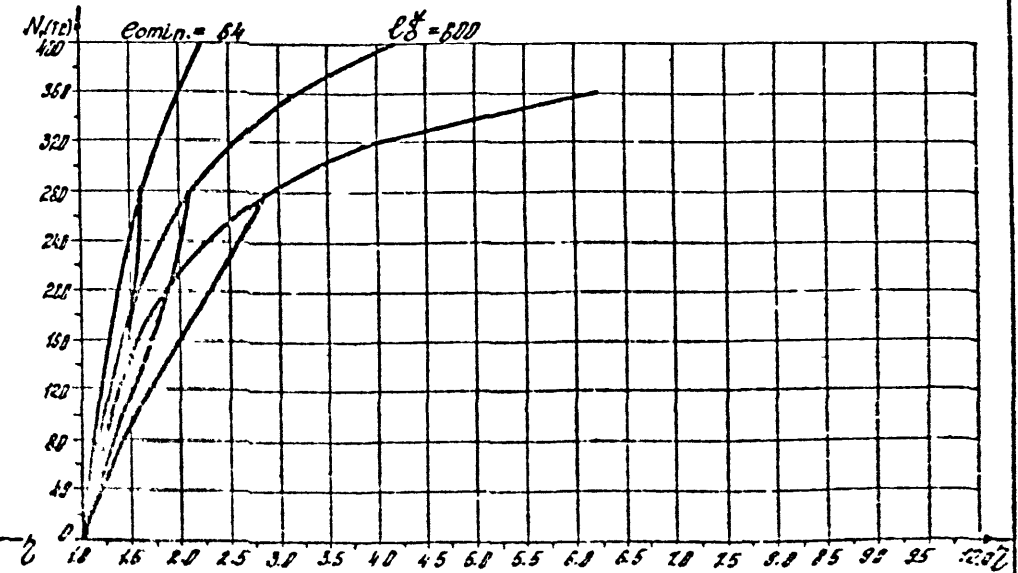
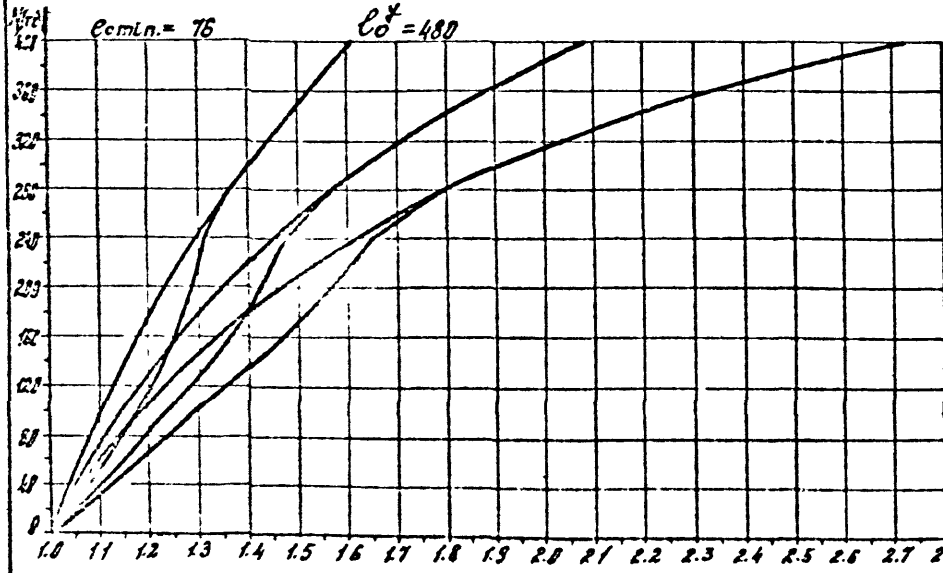
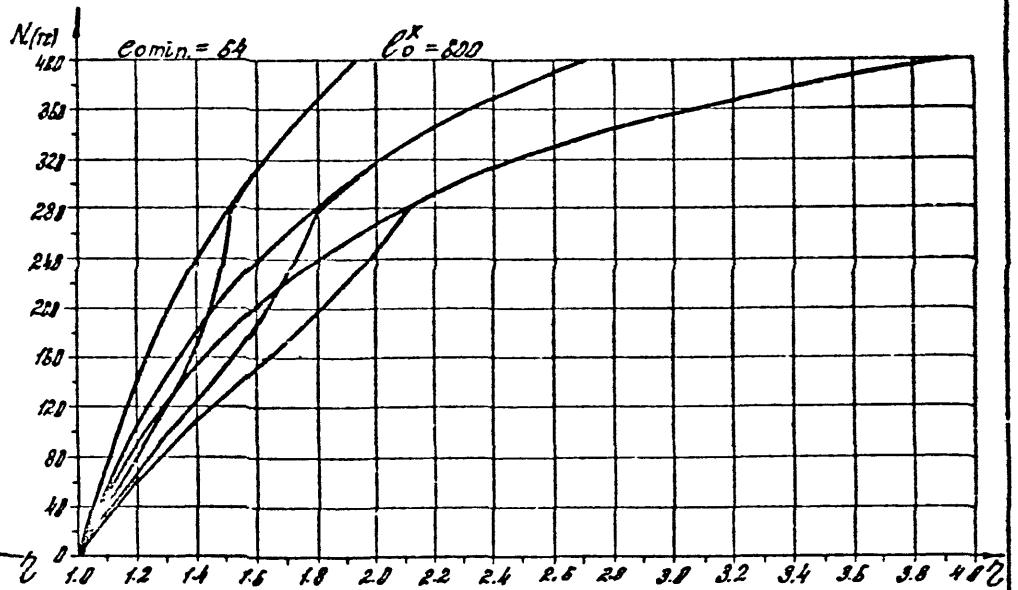
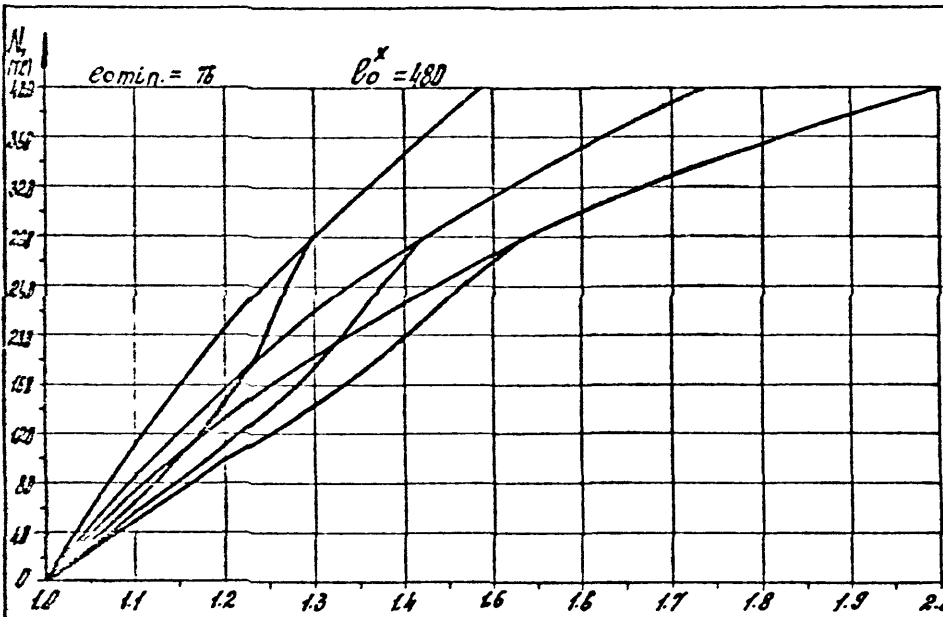

Bx. 32829 A. 148

1.020-1/87.0-6-3173

141

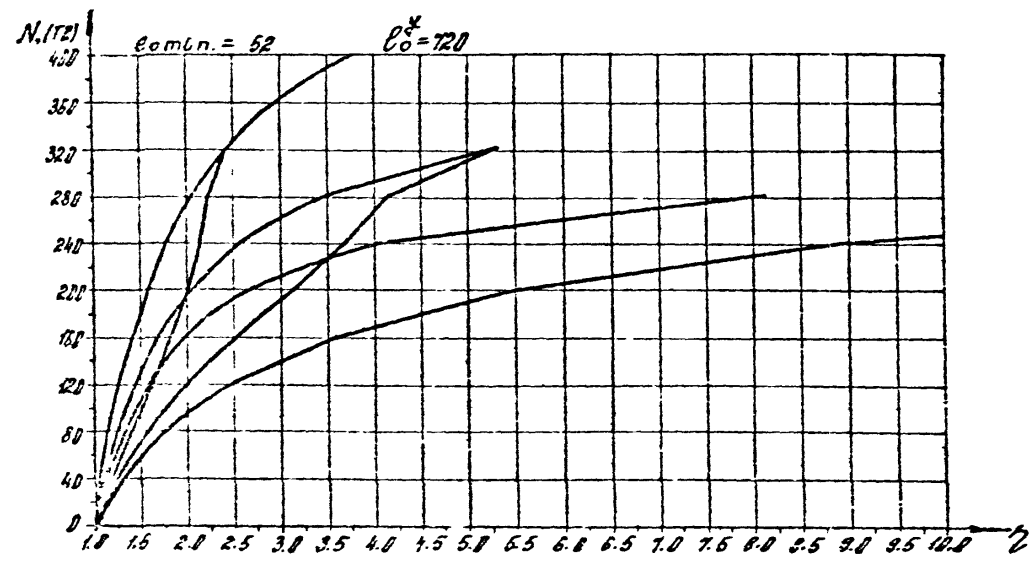
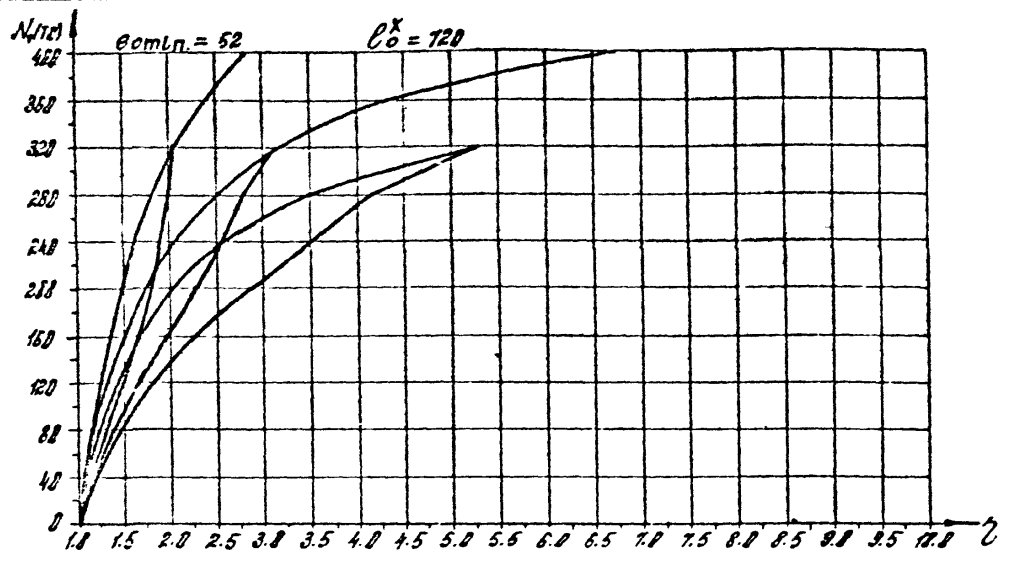

Box 268 23 A. 143

1.020-1/87. 0-6-373

<i>142</i>

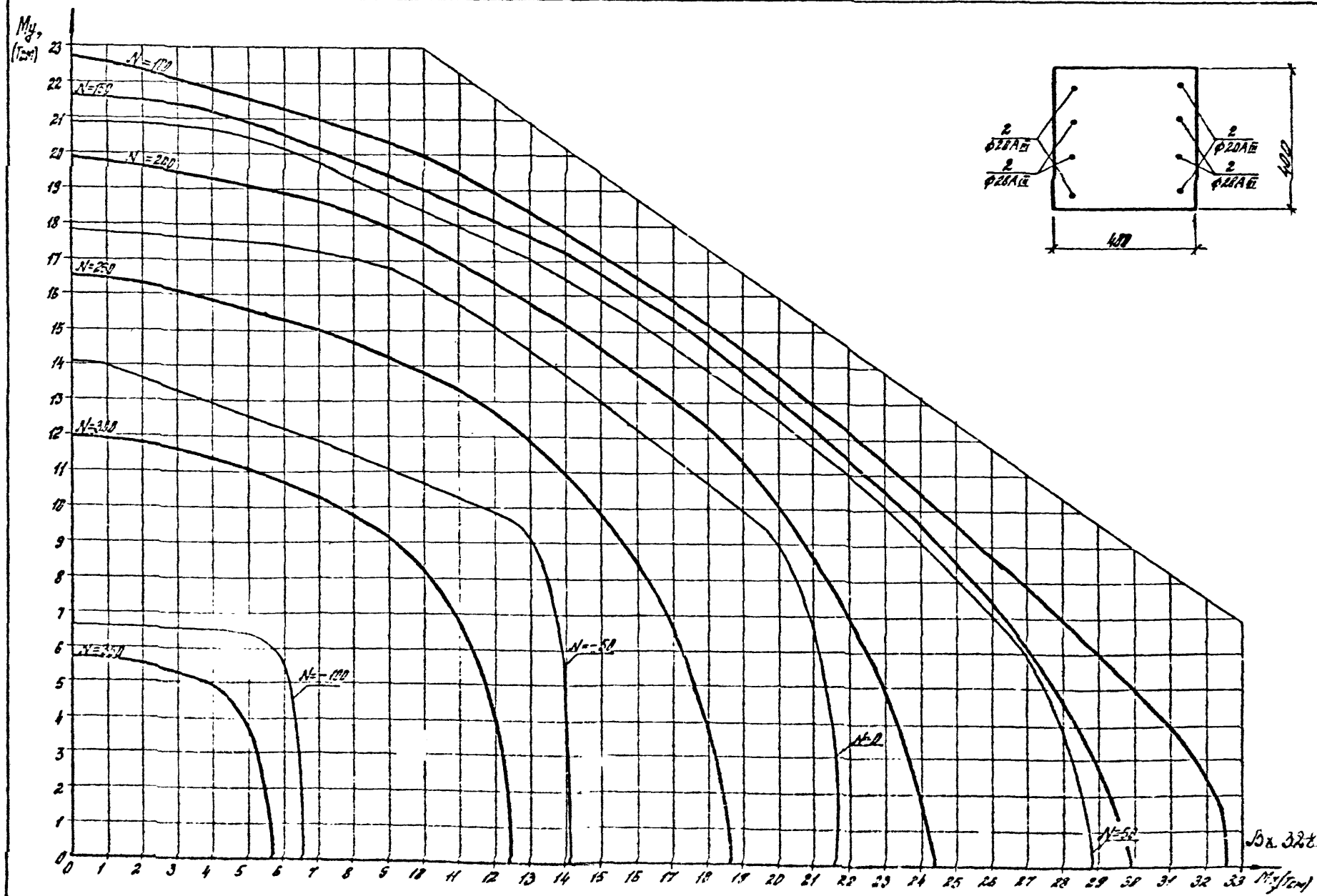

РАДОО СТОЈНО Б30 ($R_b = 155,76 \text{ T/cm}^2$ пој гчере $f_{br} = 0,9$)

1.020-1/87.0-6-3 ПЗ Лист
143

Др. Златко А. 15'

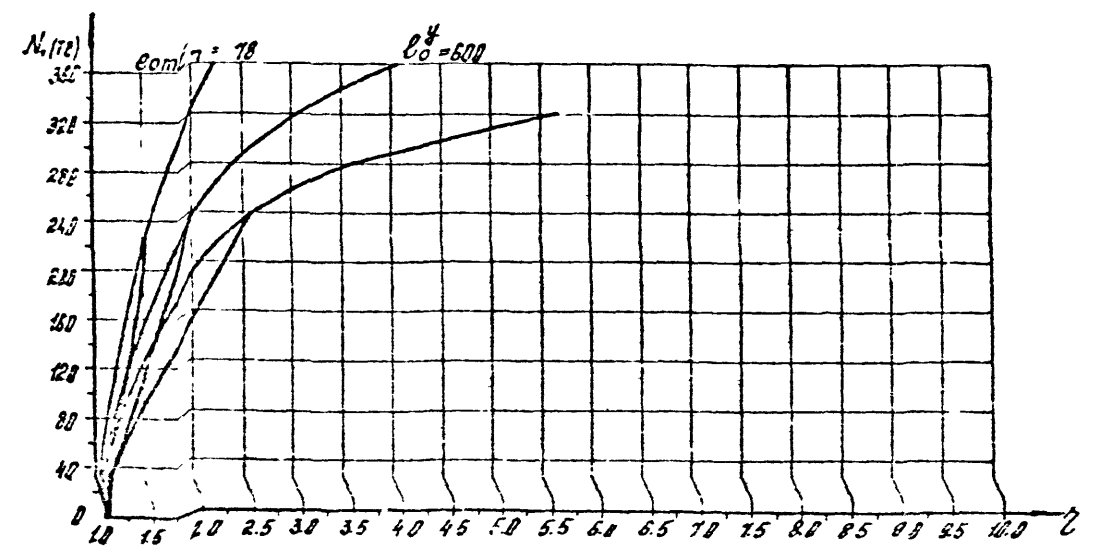
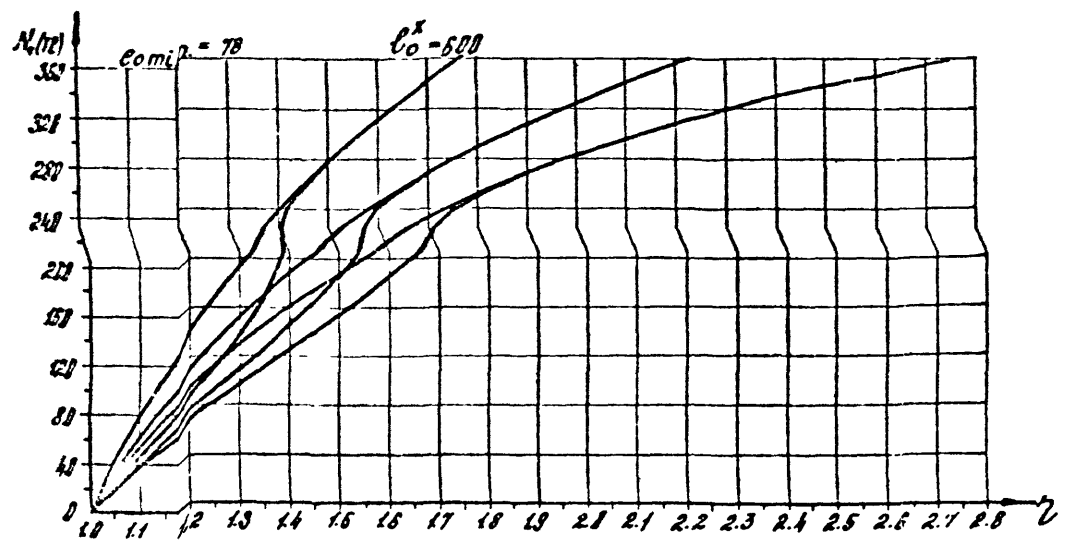

Box 32829 A. 151
1020-1/87.0-8-373
MCT
144

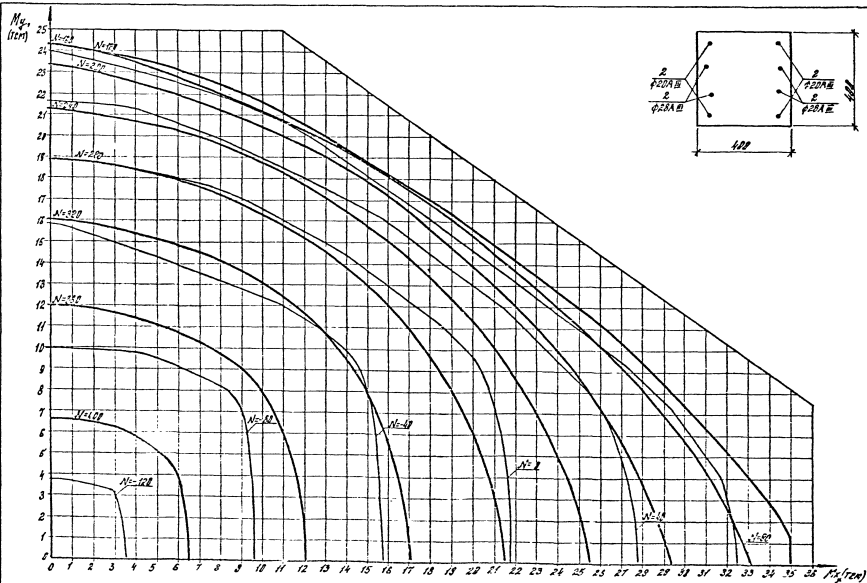

класс бетона В30 ($R_b = 19.0 \text{ т/см}^2$) при $\gamma_c = 1.10$

Вх. 32829 д. 152

1020-1/87.0-6-3/13

150

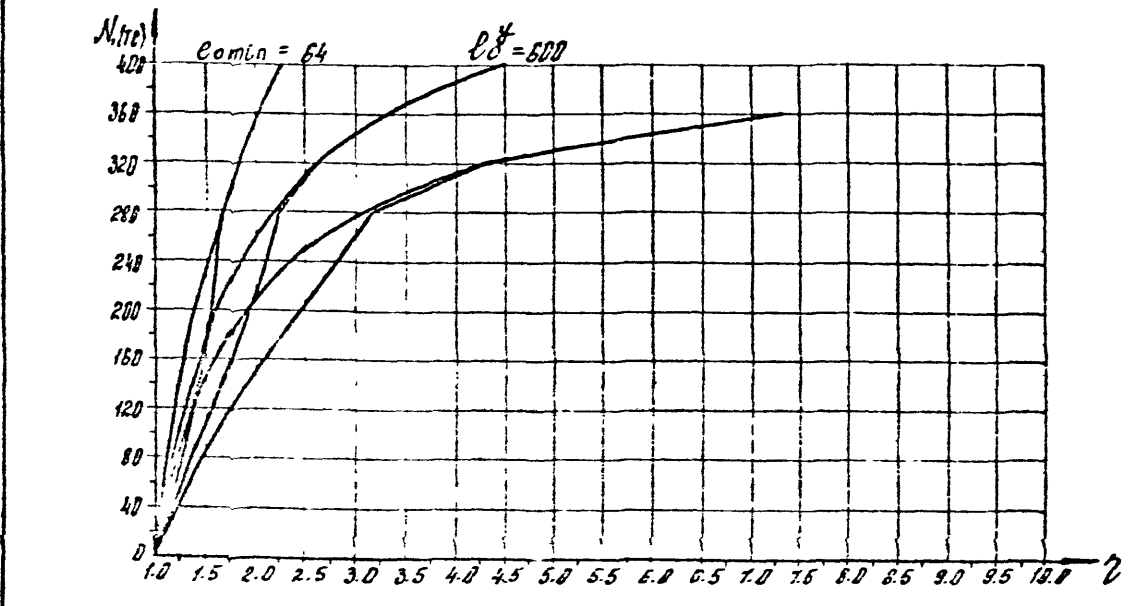
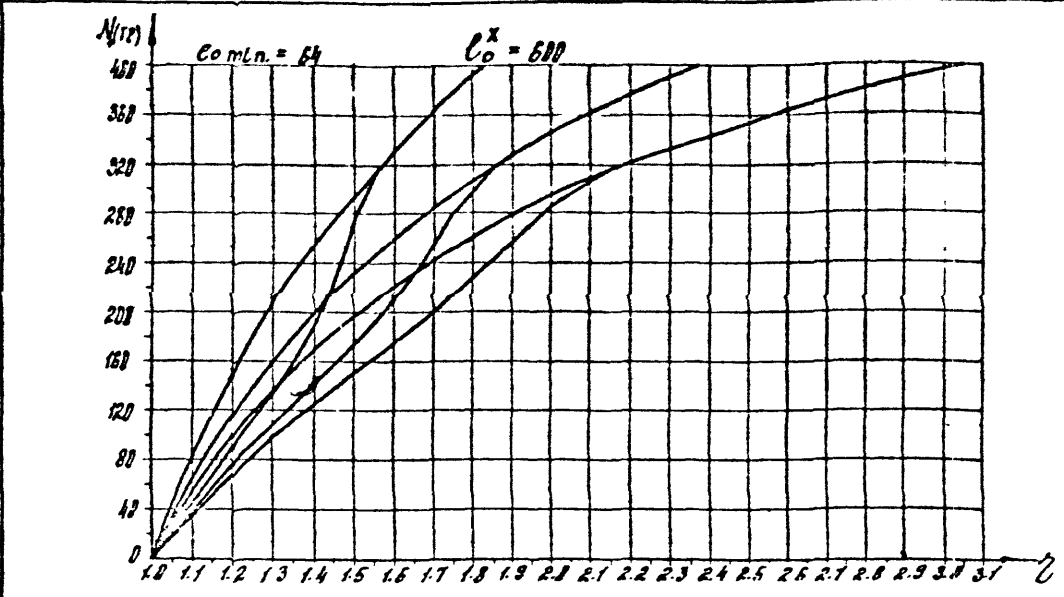

Box 35829 J. 153

1.020-1/87.0-5-3173

Sheet
146

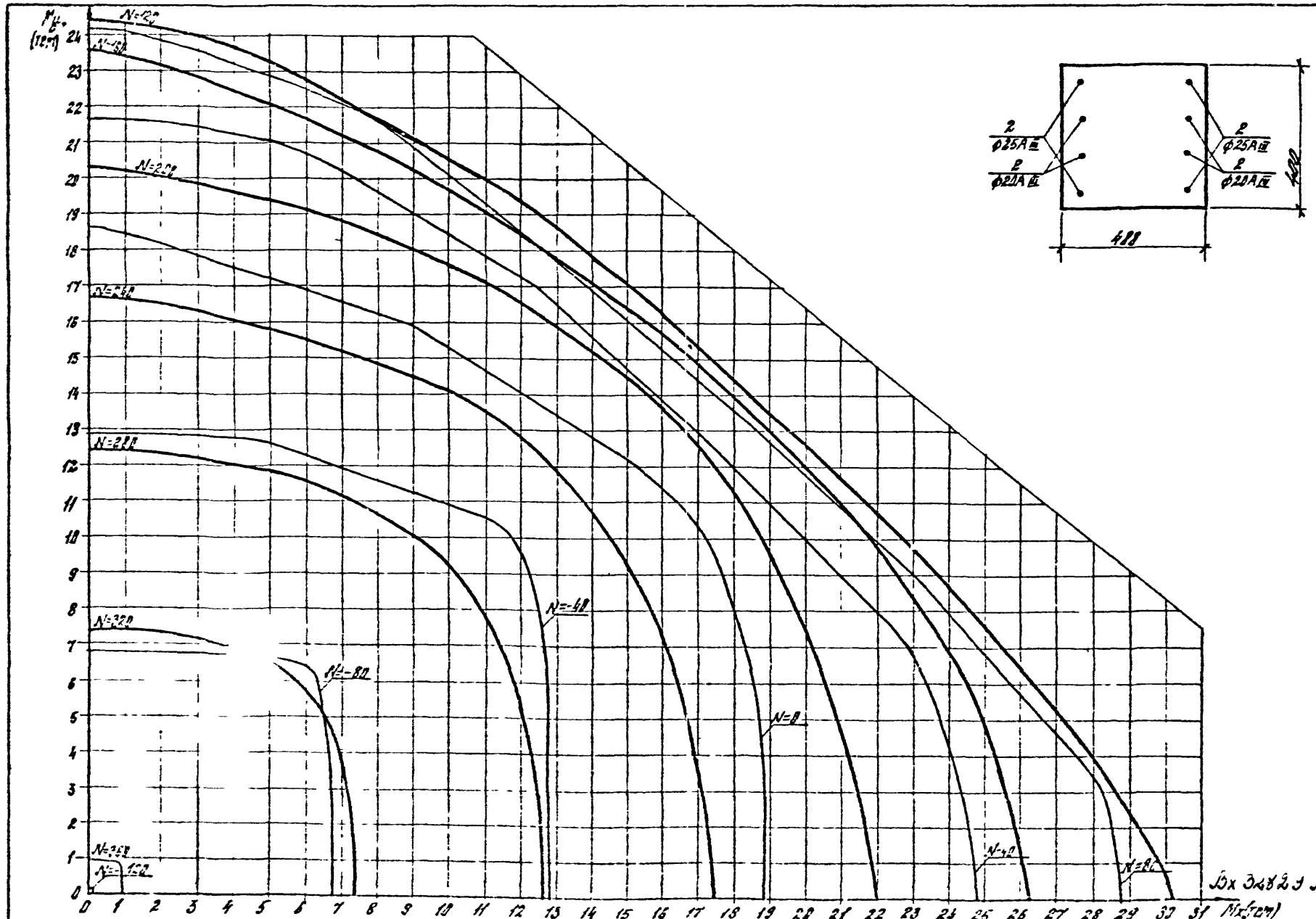

Кривые ёмкостной БСД ($R_B = 155.7 \text{ Гом}/\text{см}^2$ при $\mu_{\text{эф}} = 0.3$)

1.020-1/87. 0-6-3 113

147

Док 34823 154

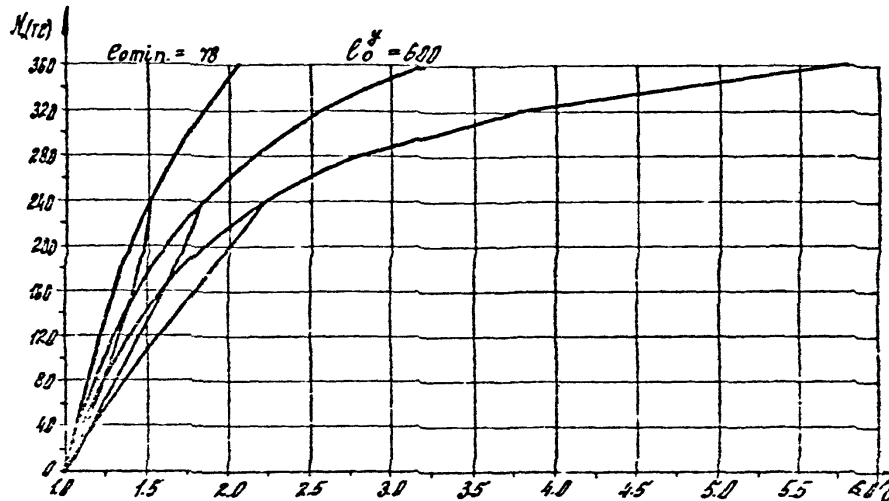
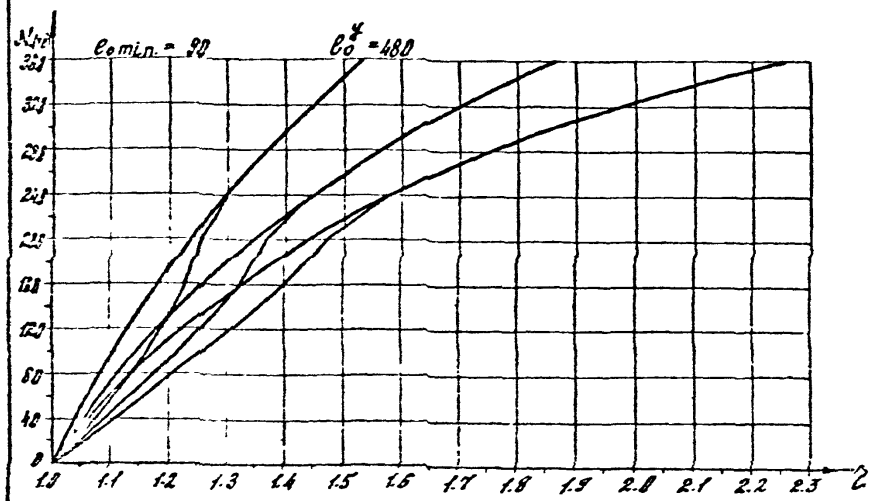
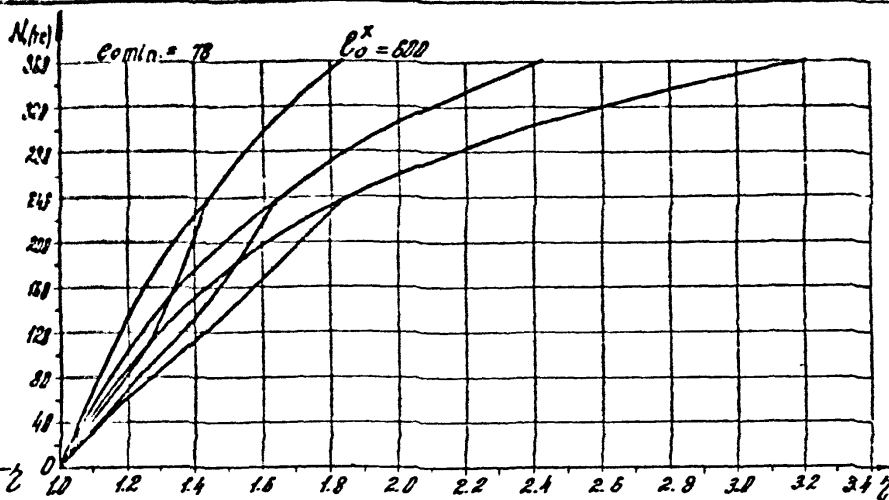
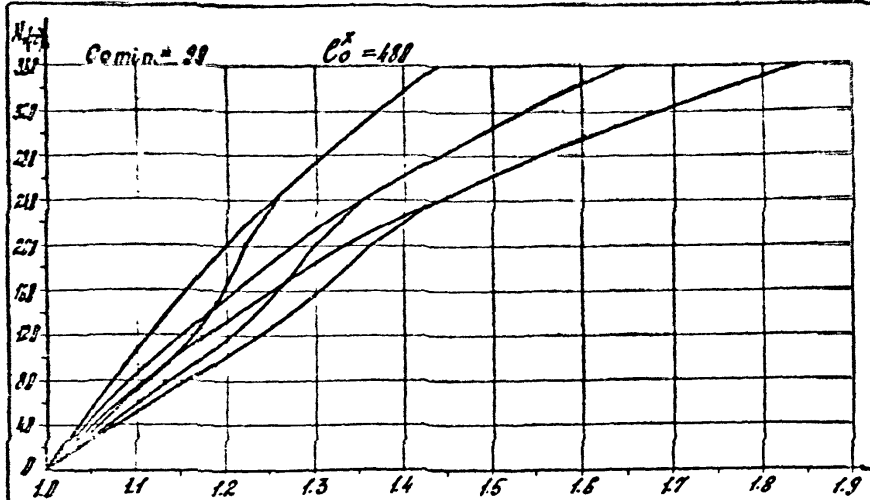

Box 32829 A.155

1.020-1/87. 9-5-3 113

sheet
148

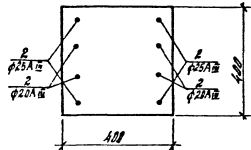
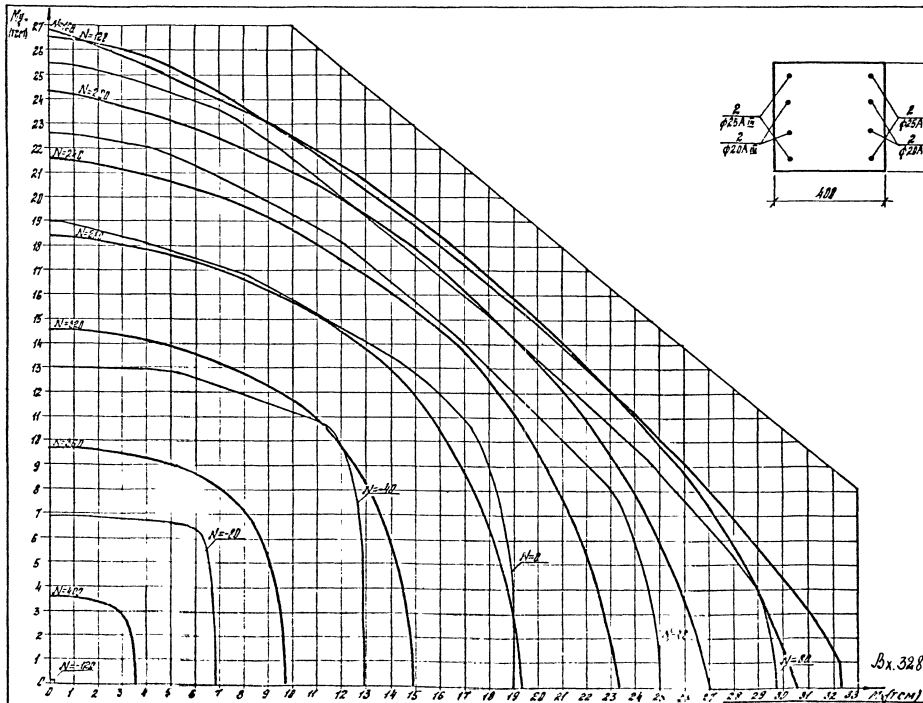

Вх. 3282.9 а. 156

масса железа 120 (R_ж = 120.3 мс/лн² при γ_ж = 1.10)

1020-1/87. 0-6-3113

143

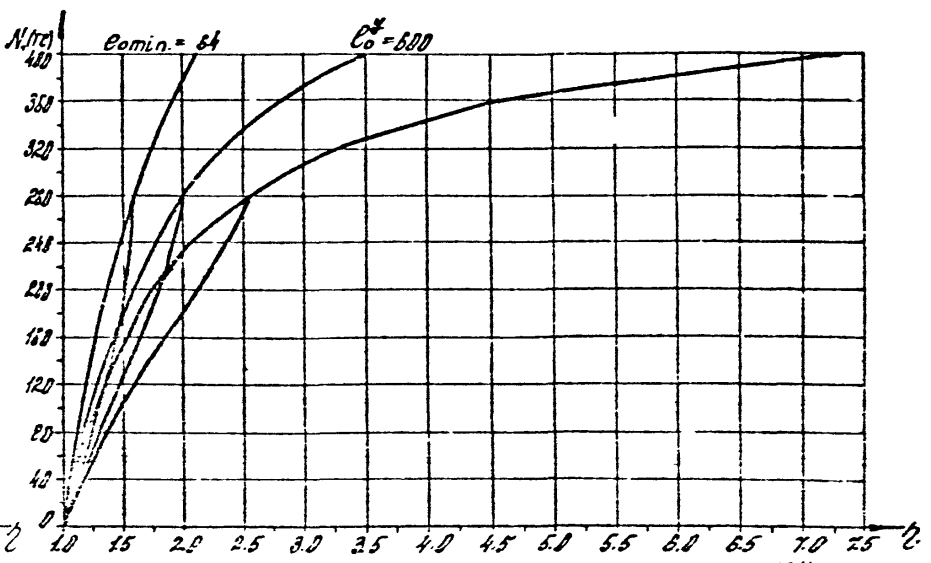
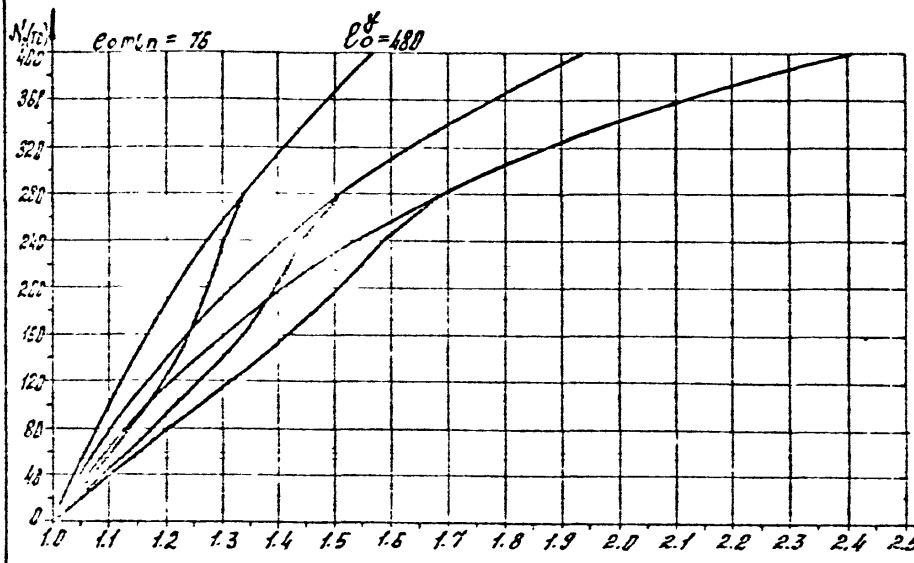
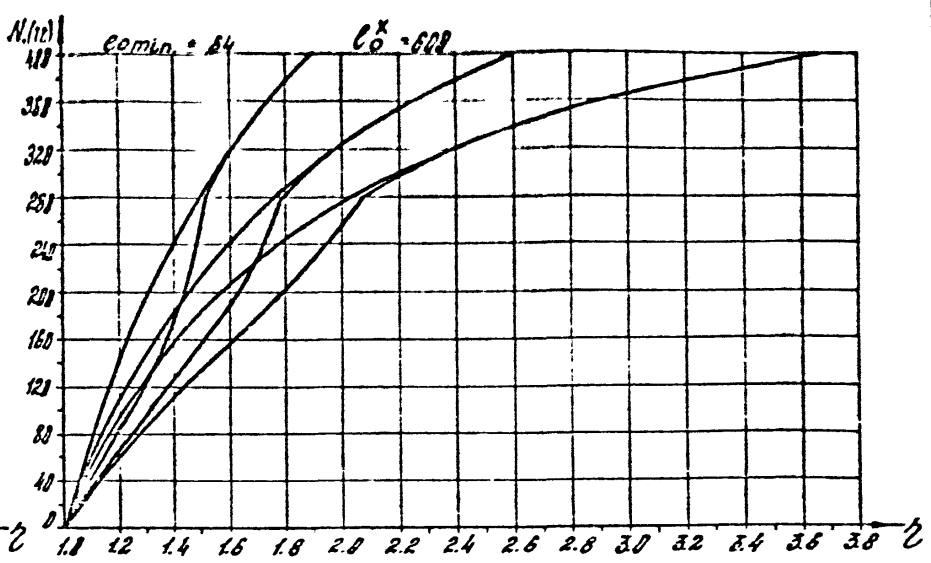
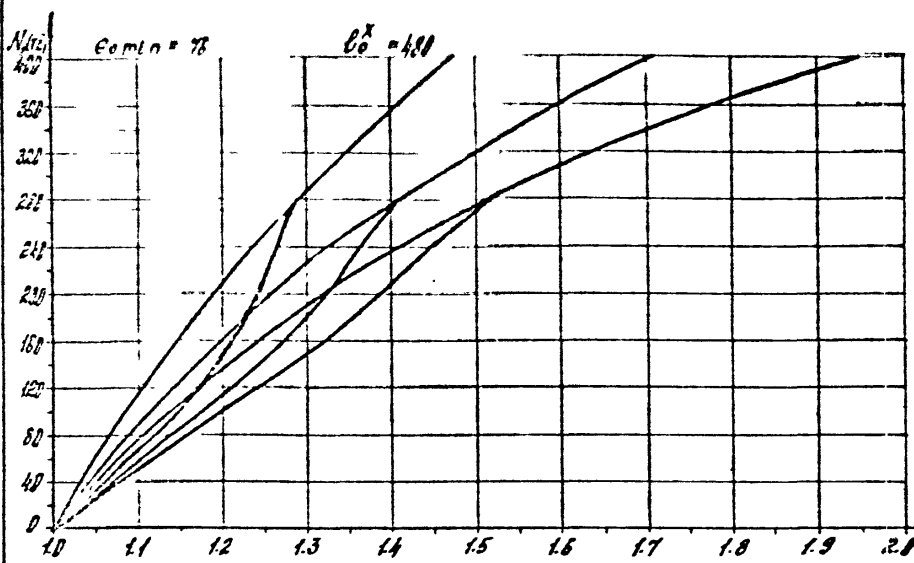

Box 32829 J. 157

1020-1/37. 0-6- 3 113

150

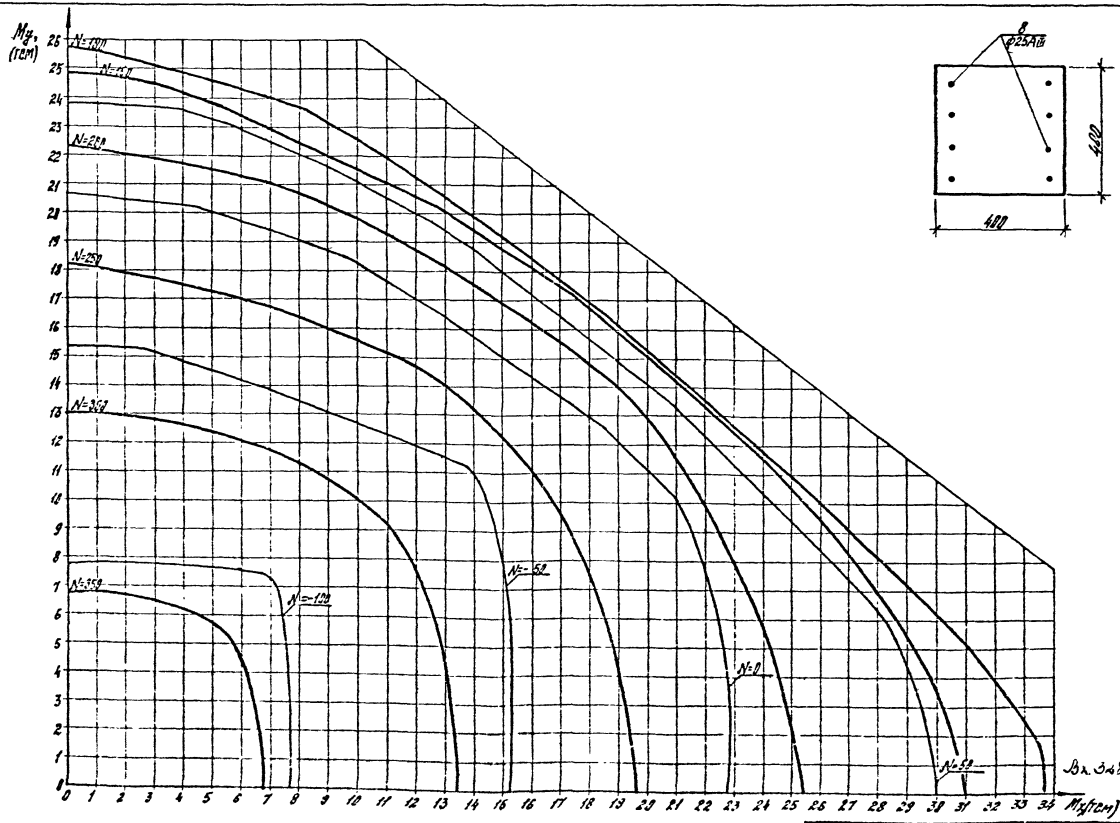

Вн. С.А.К.У. а. 103

РАССЧ. СЕРИИ 830 (R_b = 155 Тс/см²) и Р_н здесь (β₂ = 90)

1020 - 1/87. 0-6-3173

1/127
151

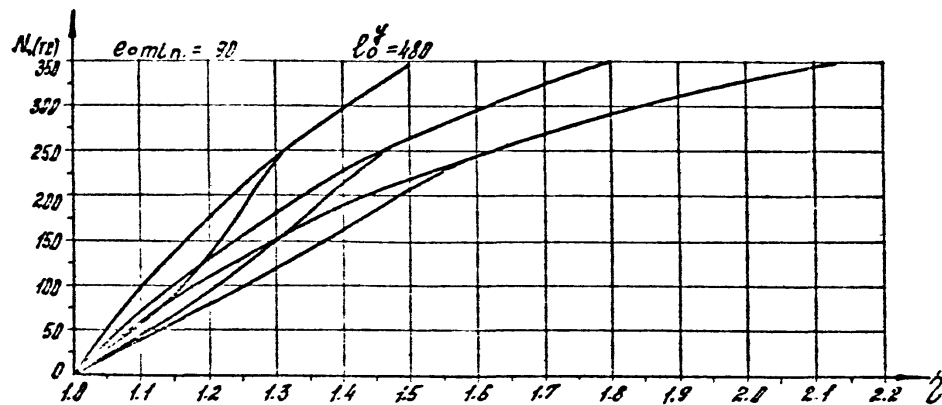
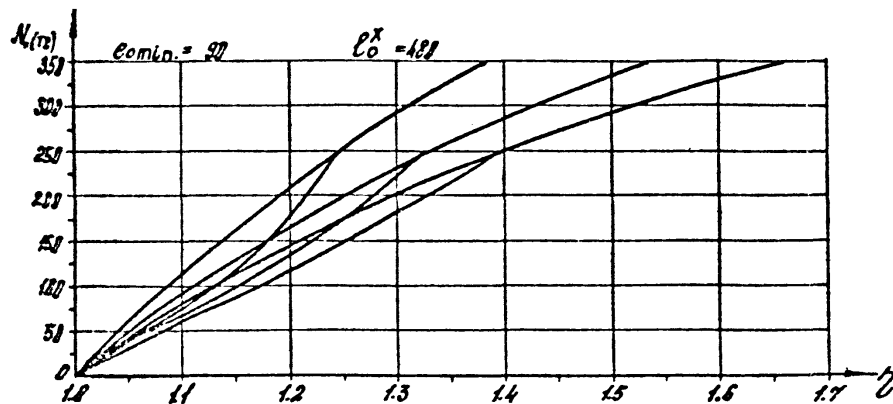

Bx. 32829 A. 159

1.020 - 1/87. 0-5-3 173

152

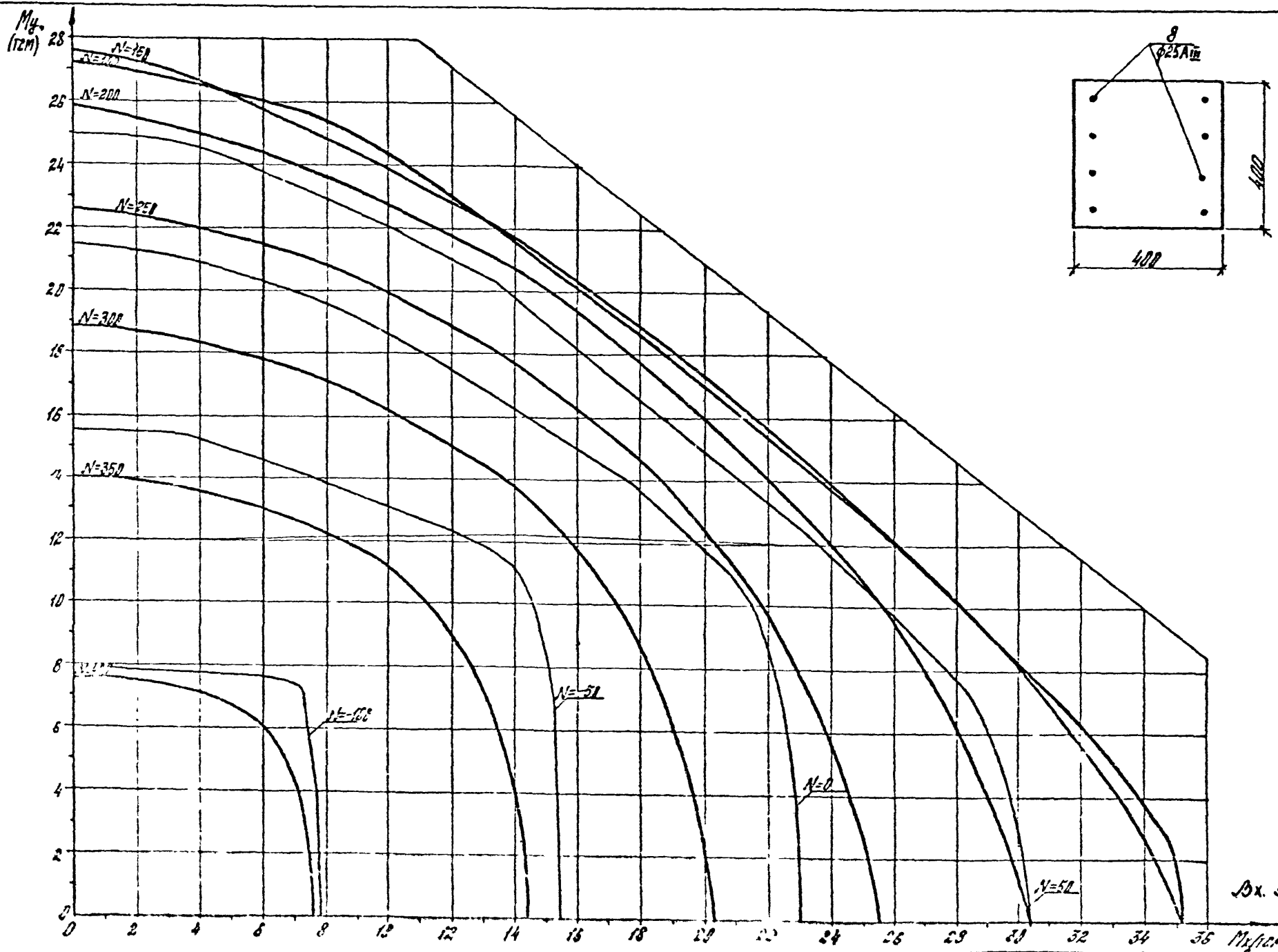

Дх. 32829 л. 160

Бетон марки В30 ($R_b = 130 \text{ кг/см}^2$ при $\sigma_{br} = 1.15$)

1.020-1/87. Д-6-3 ПЗ

1.57
153

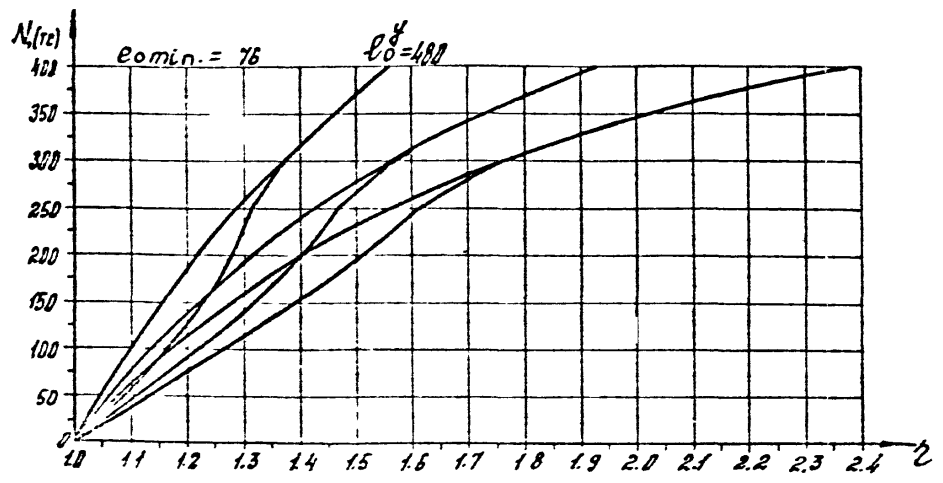
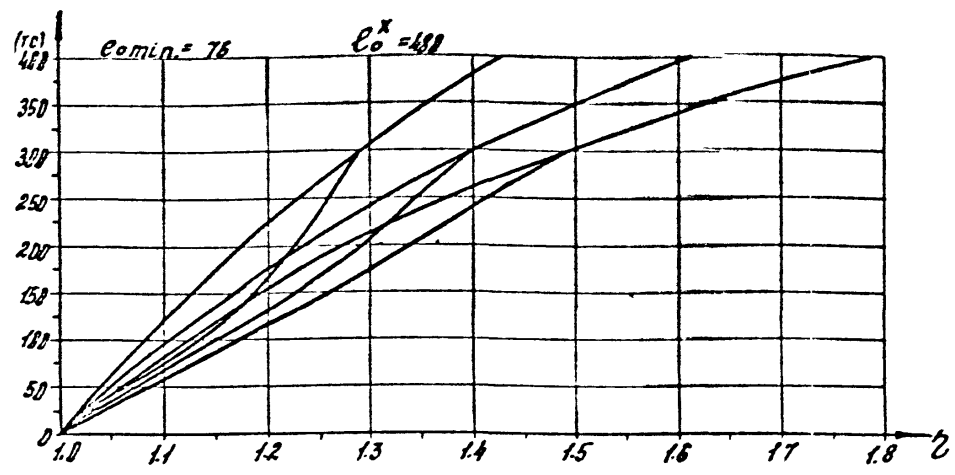

Bx 32859 A. 161
1020-1/87. 0-6-373

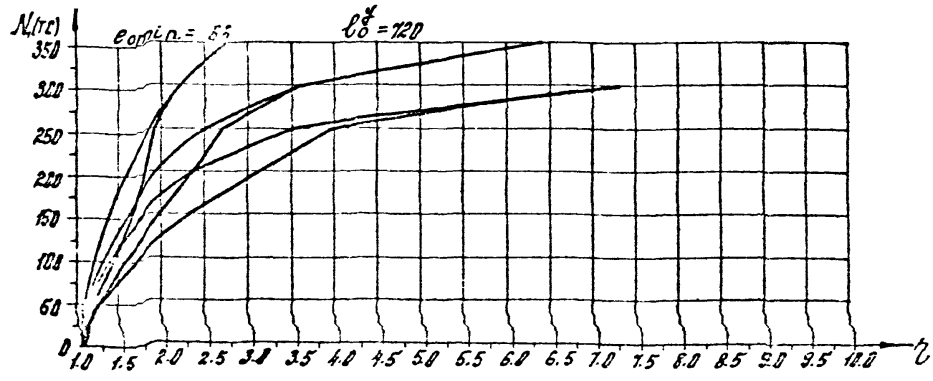
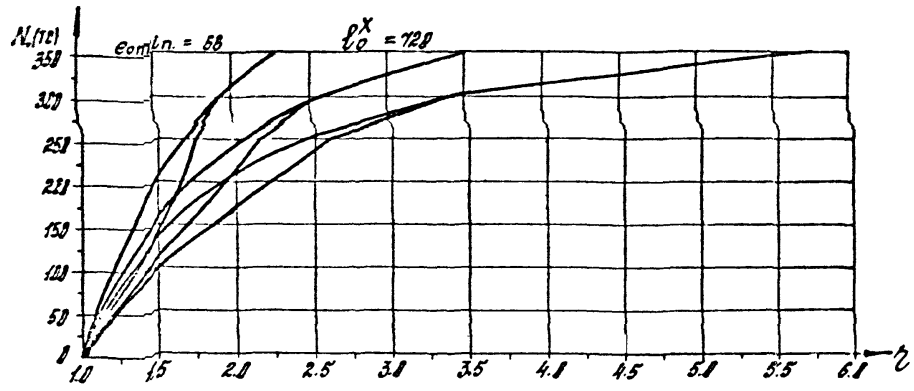

Rx. 32829 J. 162

1.120 - 1/87.0 - 6 - 3 113

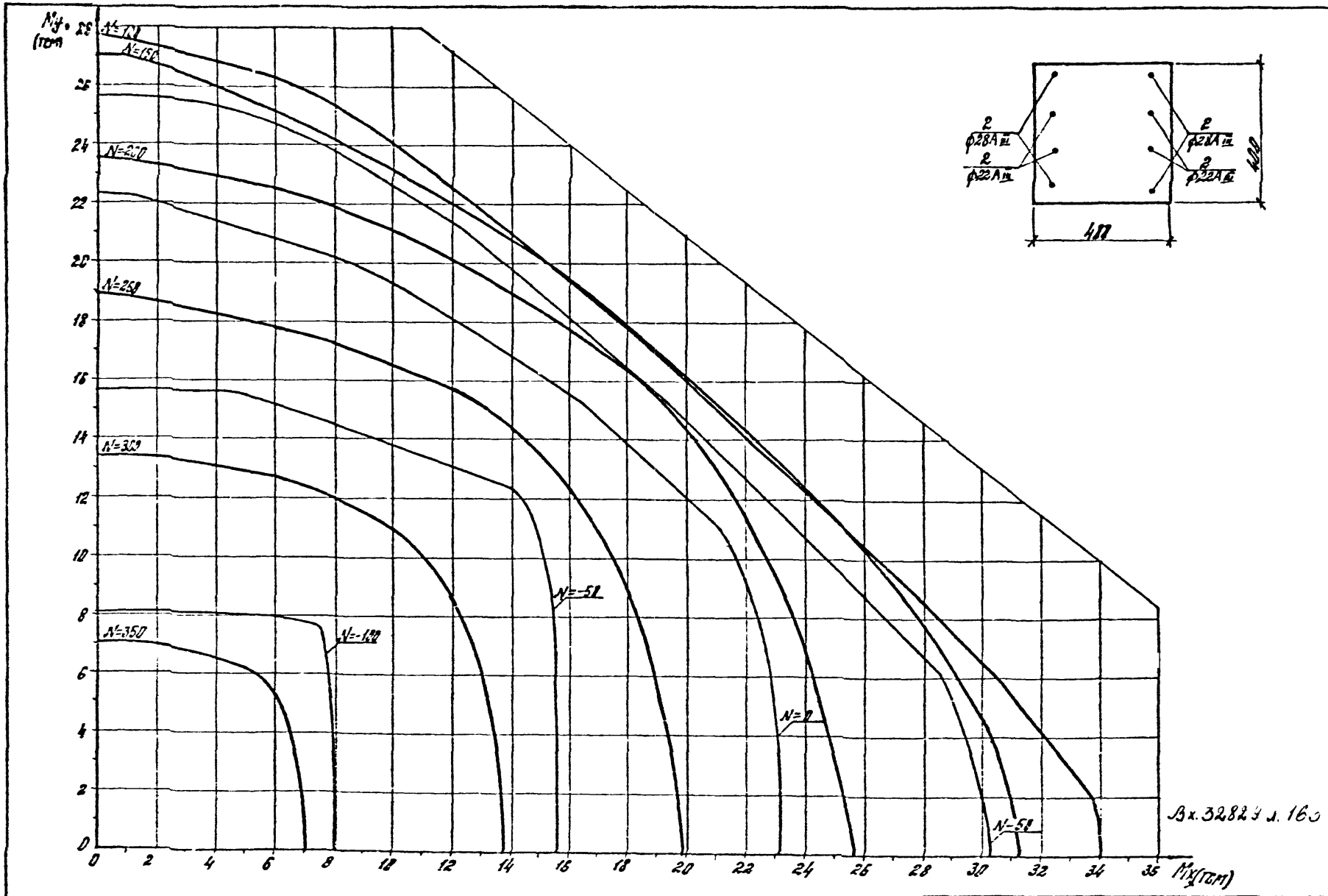

κλάση σιδηρού Β30 ($R_b = 155 \text{ Tkp/c/εμ}^2$ που υφίσταται $f_{ct} = 0.9$)

1.020 - 1/87. 0-6-3 Π3

155

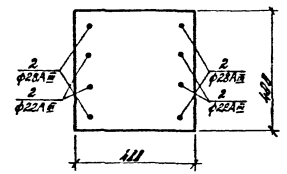
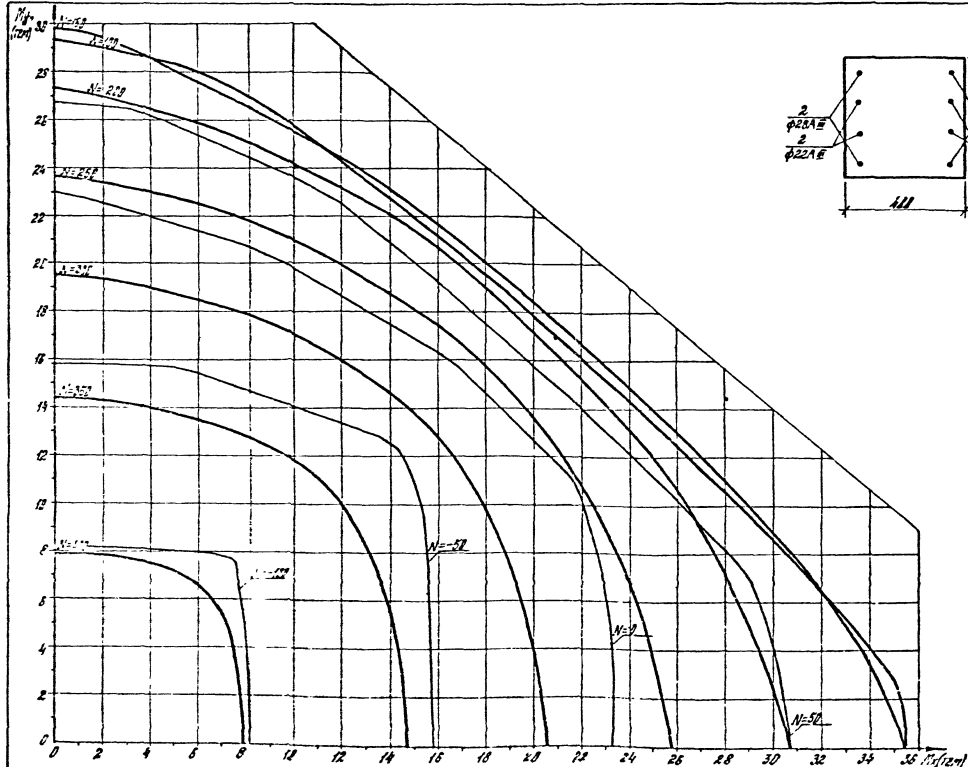

Кривые для бетона Б30 ($R_b = 11000 \text{ kg/cm}^2$) при $\mu_2 = 1.10$

Док. 32829 д.164

1.020-1/87. 0-6- 3 113

лист
157

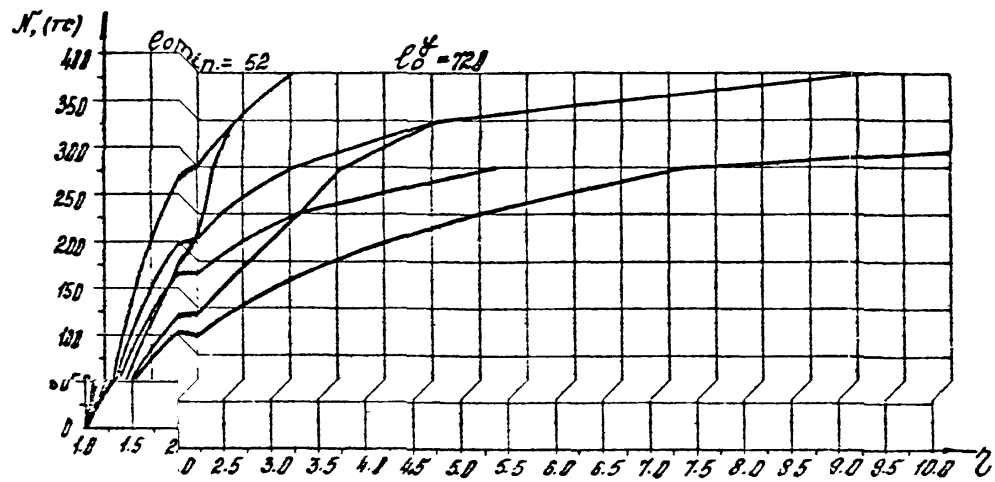
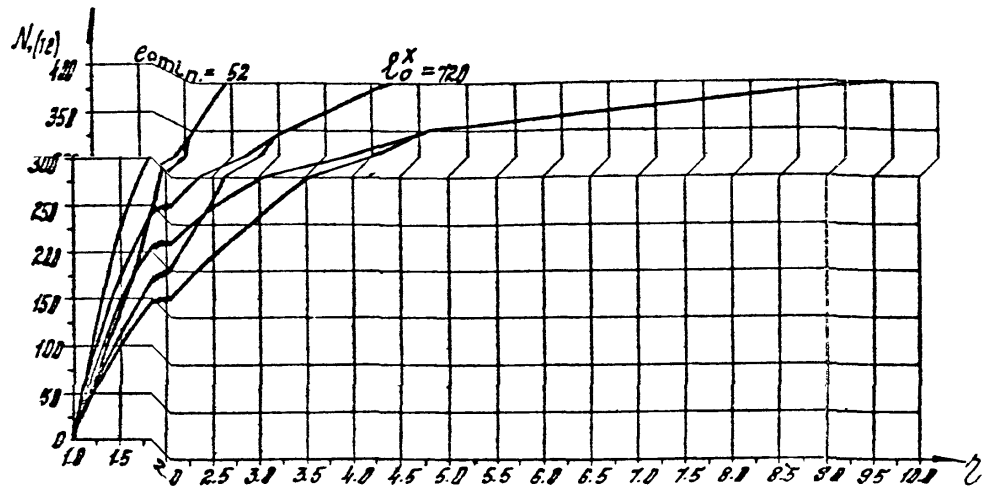

10x. 34823 4.165

1.020-1/87. 0-6- 3 173

158

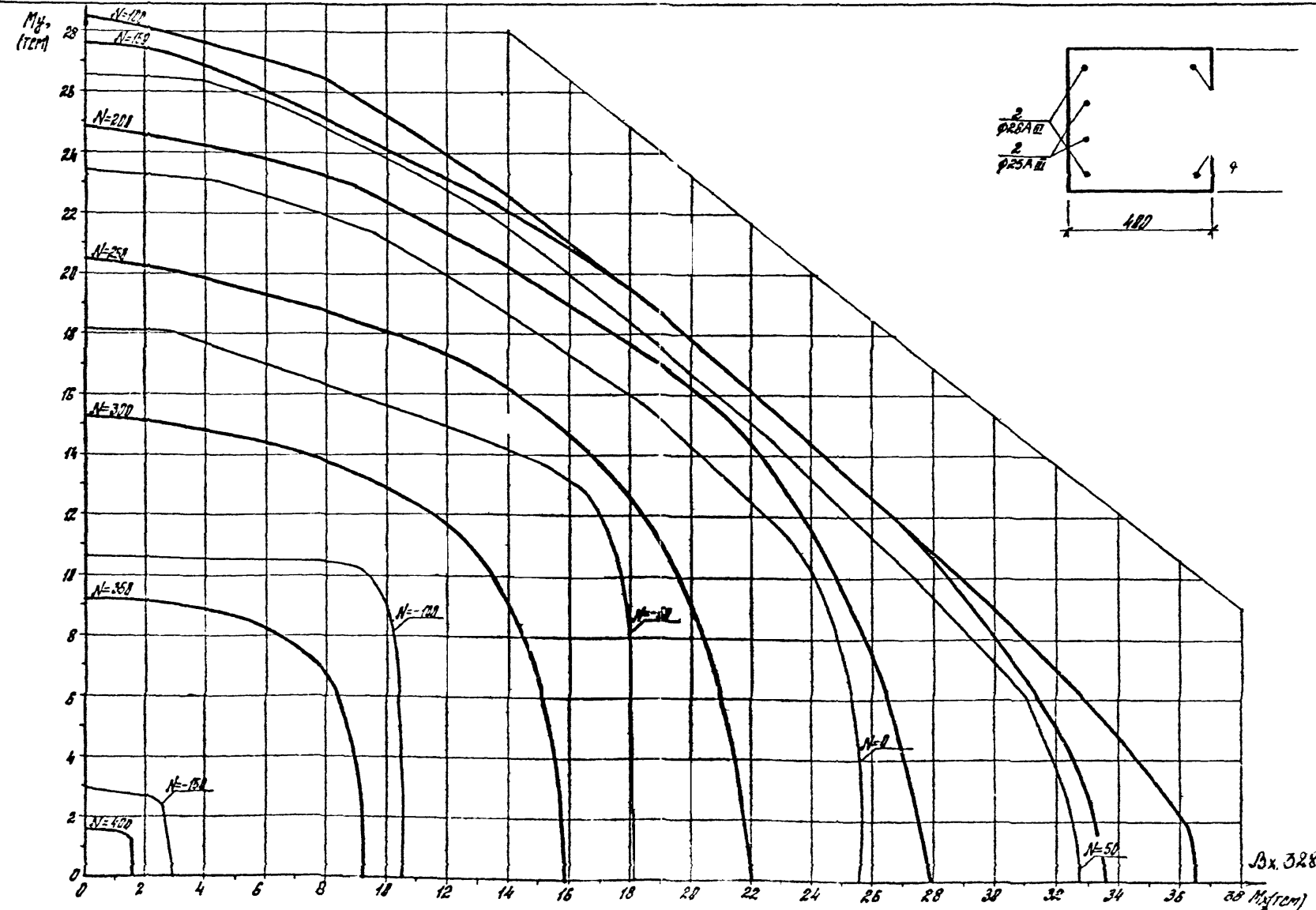

РАБОТА СЕЧЕНИЯ В30 ($R_b = 155 \text{ ТМЦ/см}^2$ при учете $\gamma_{b2} = 0.9$)

1.020-1/87.0-6-3 173

159

Вх. 32823 а 166

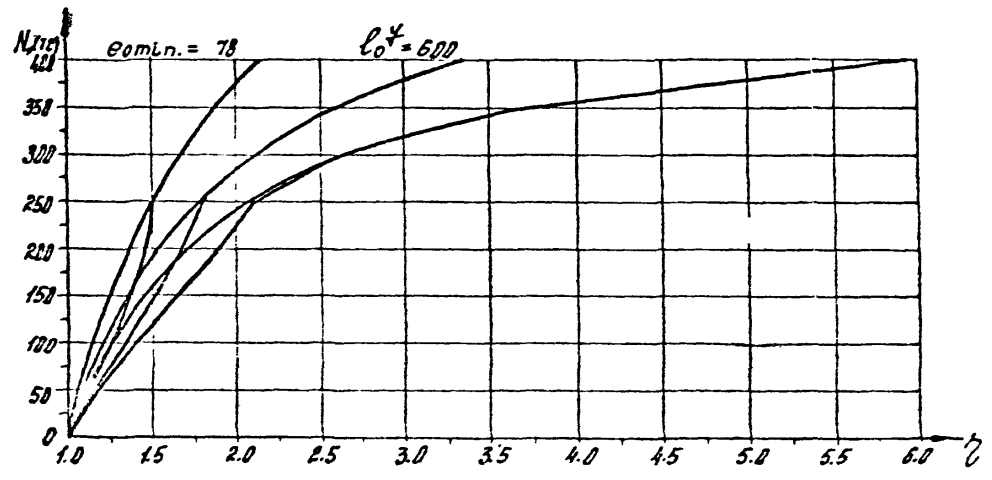
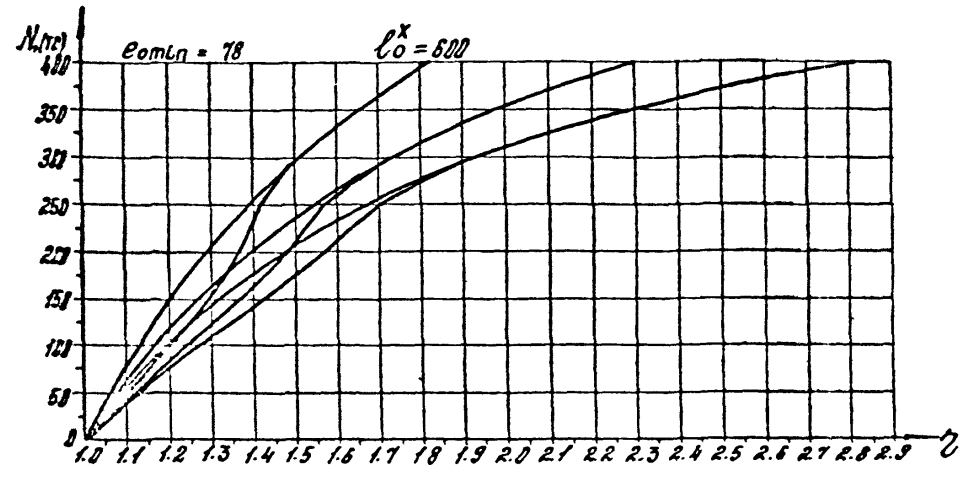

Bx 32829 2.164
1.020-1/87. 0-8-3 113
160

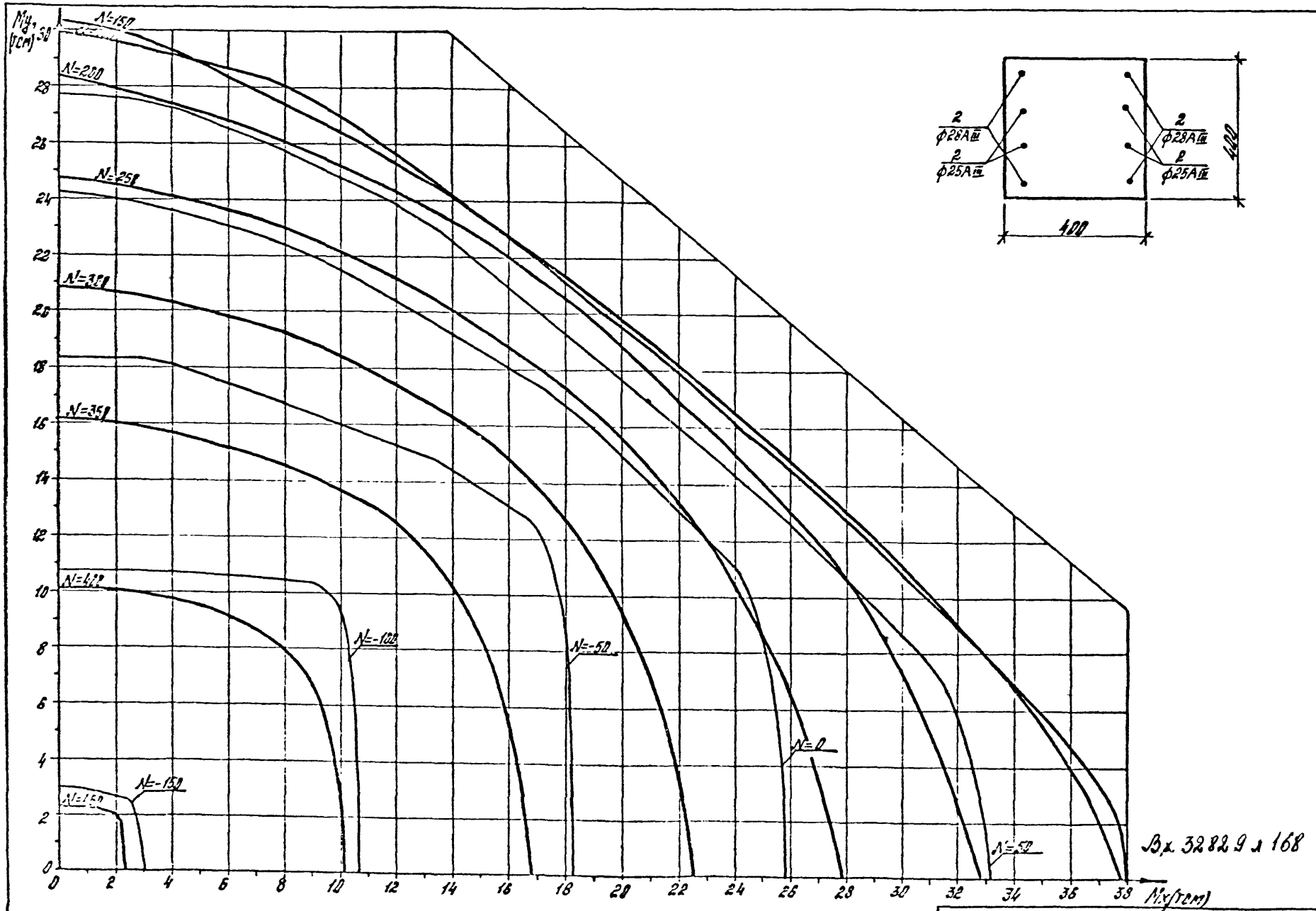

Бетон марки Б30 ($R_b = 18.235 \text{ MPa} / \text{cm}^2$ при $\gamma_{bt} = 1.10$)

В.п. 3282.9 и 168

1.020-1/87.0-6-3 ПЗ

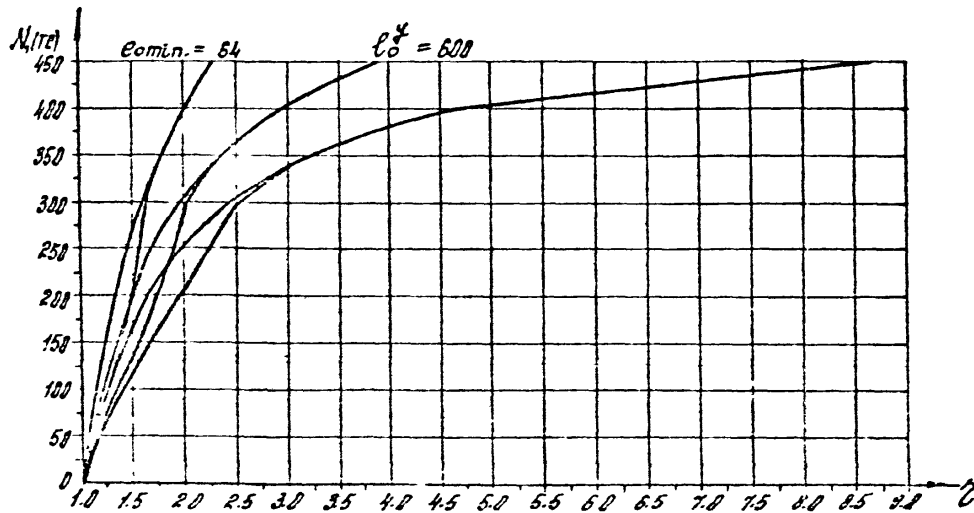
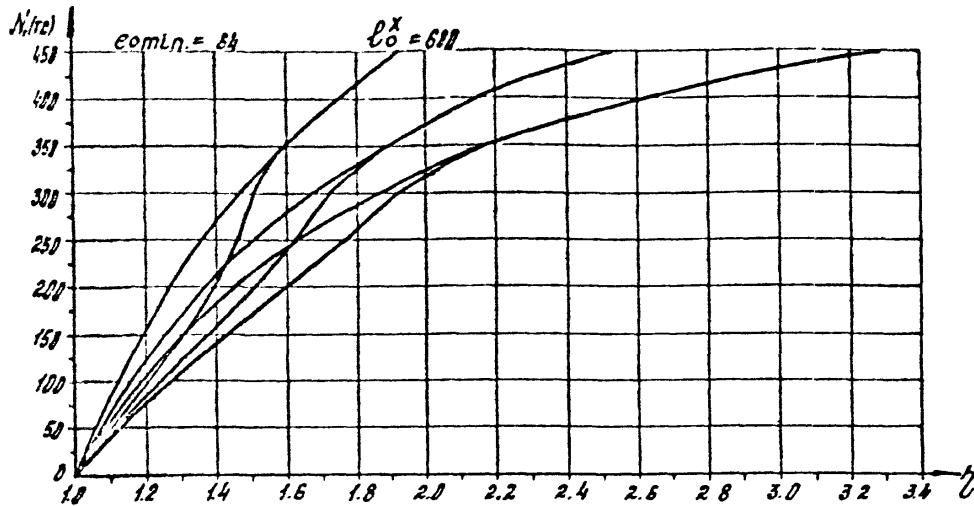

Bx. 32829 A.169

1020-1/87 D-5-3173

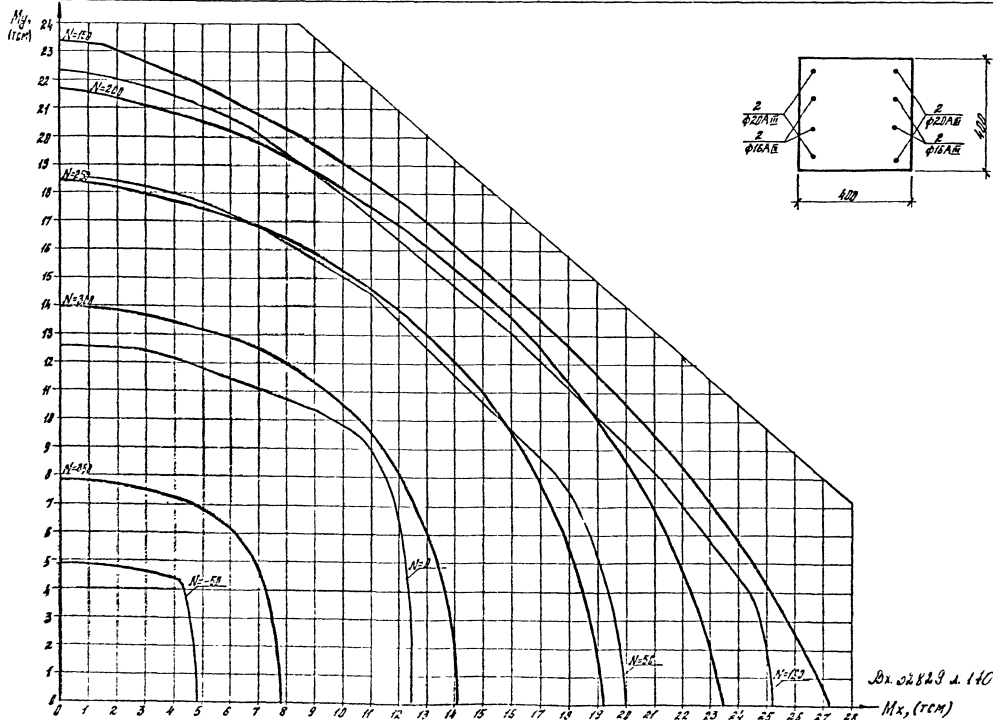

Ст. 22823 и 140

Станд. Строит. 840 (86-201 5 мм/л/л) (1/2=0)

1.020-1/87.0-6-3/13

1/10/13
163

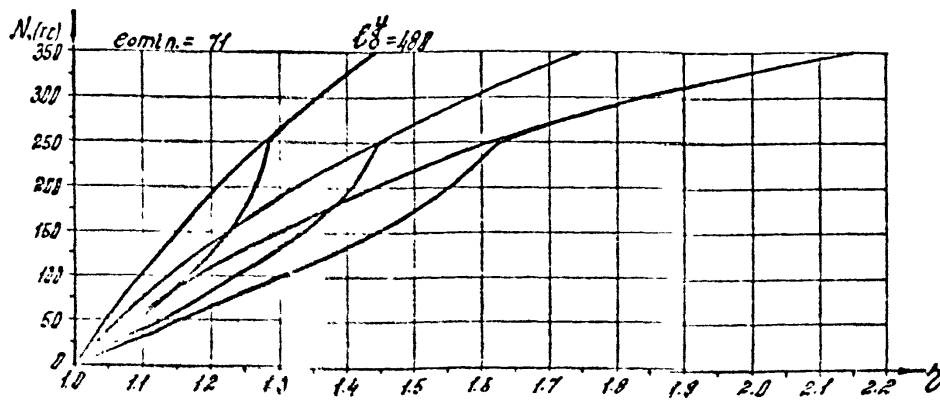
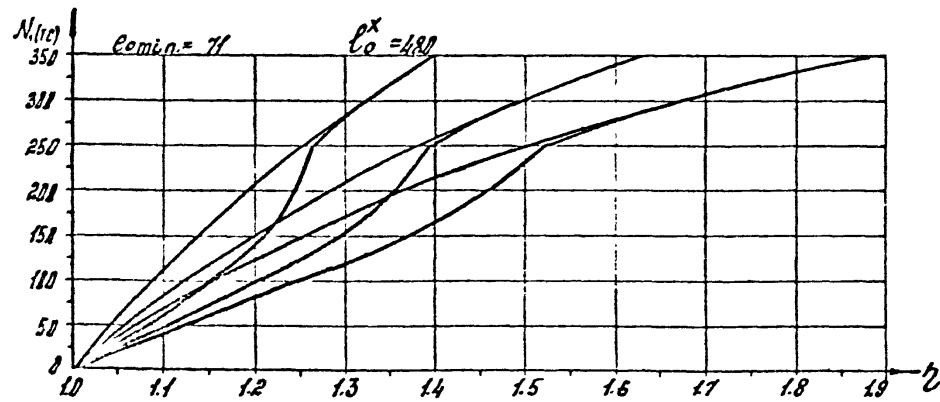

Bx 32829 J. 171

1.020 - 1/87.0-6-3 113

165

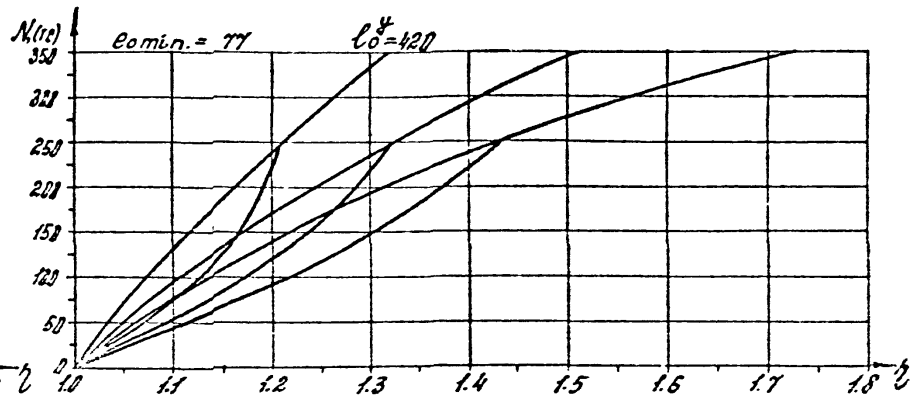
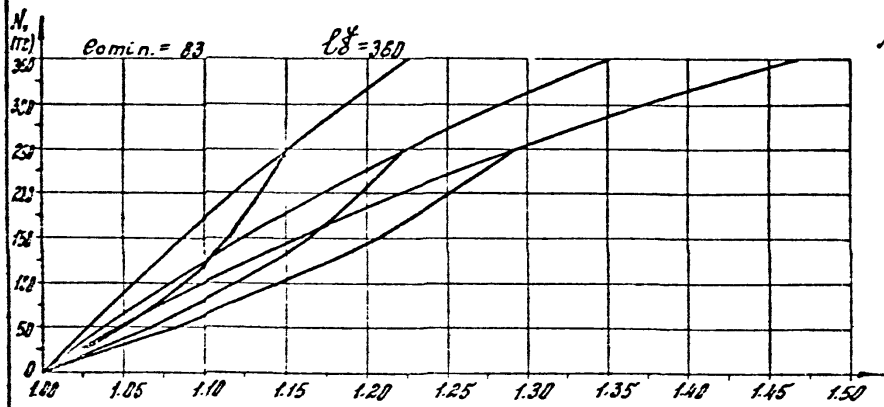
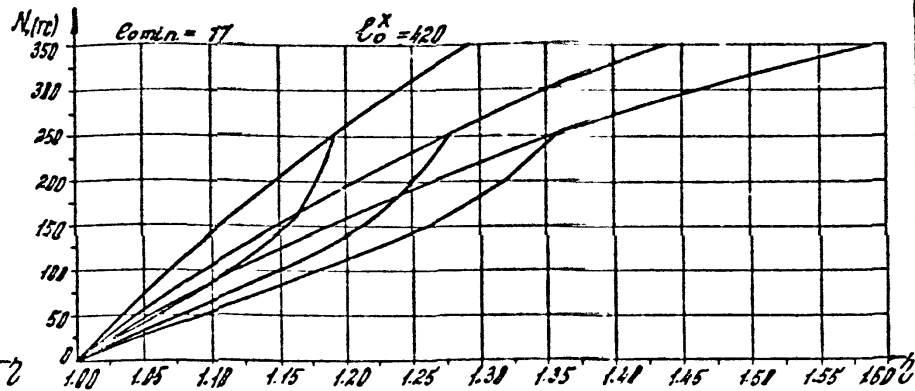
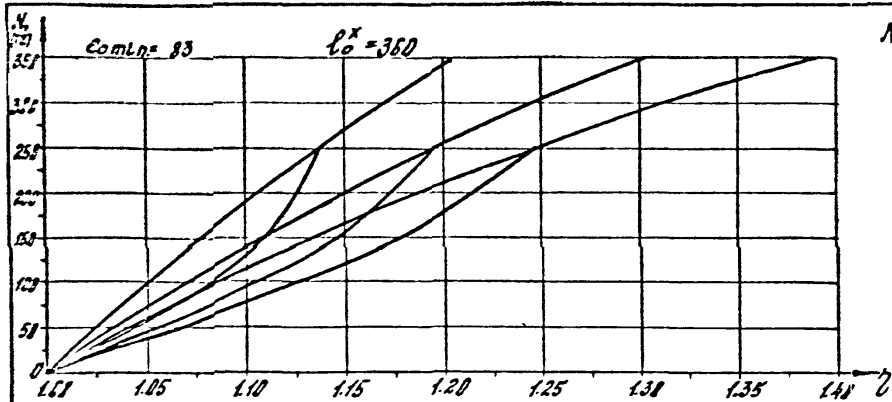

Bx 32829 A.142

1.020-1/87. 0-6-3 173

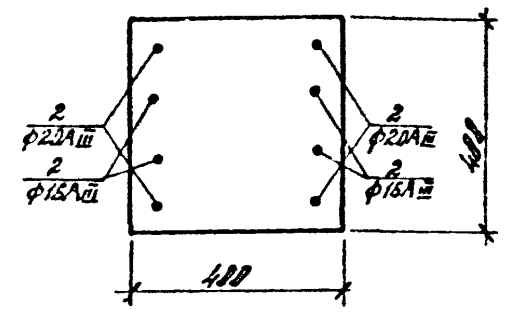
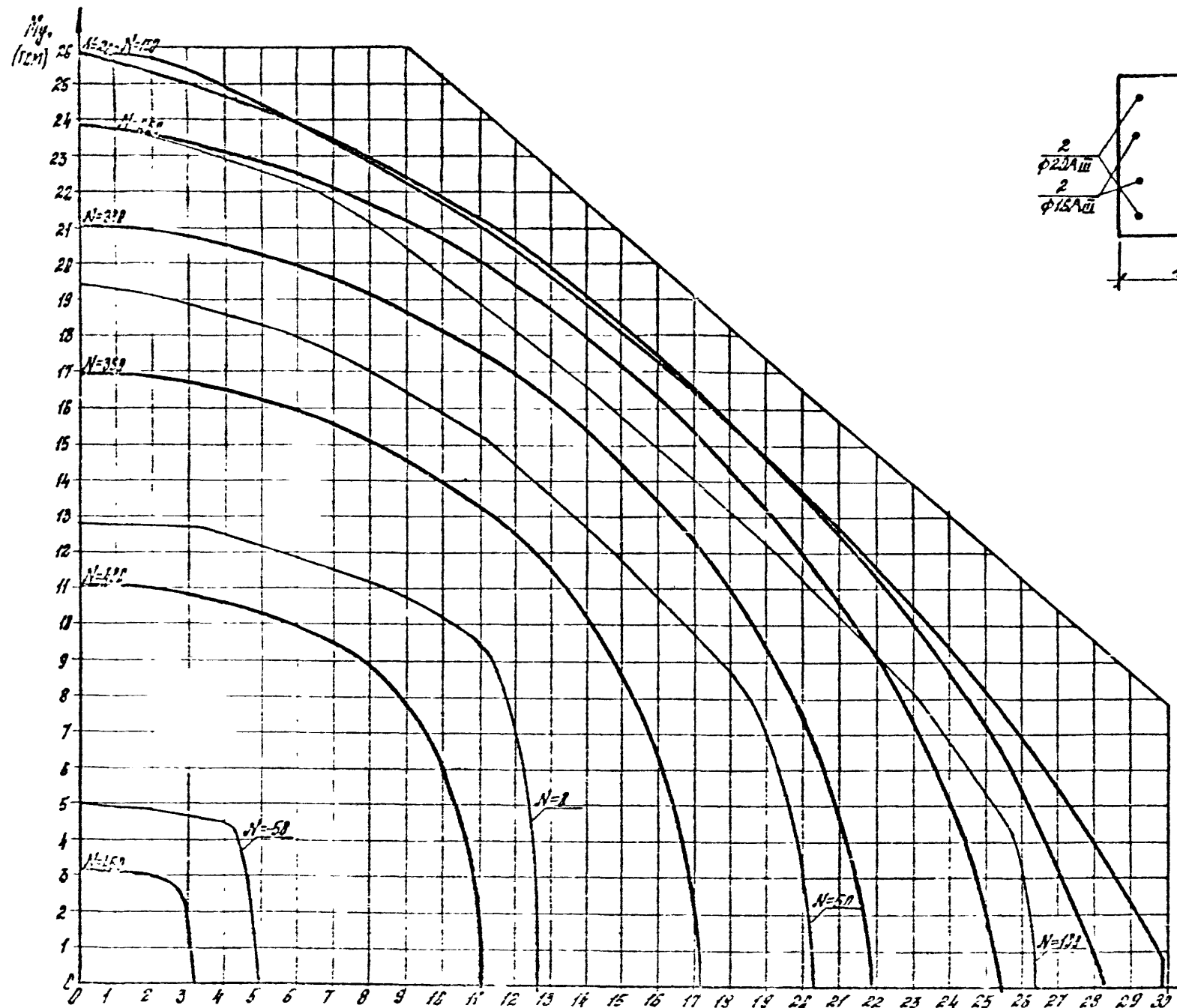

Бетон В40 ($R_b = 24.5 \text{ т/см}^2$ при $\sigma_{сж} = 1.10$)

Дж. 32829 Л. 173

1.020-1/87.0-8-3113

Лист
166

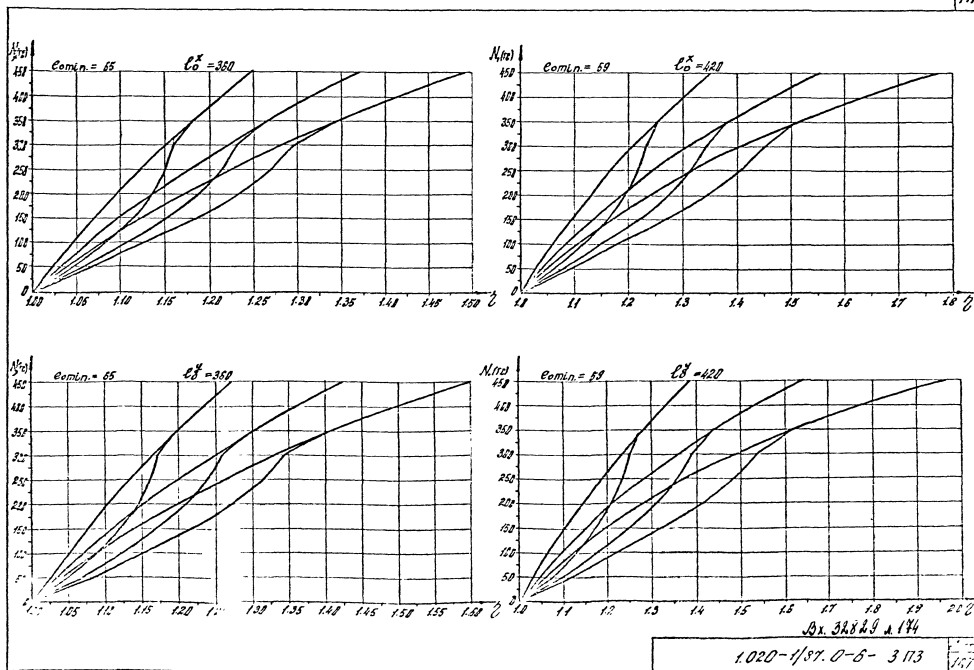

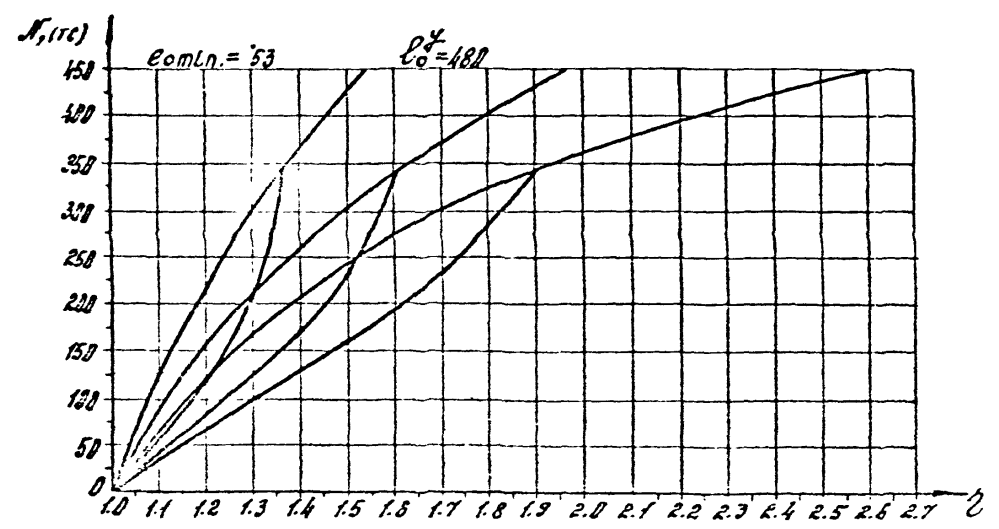
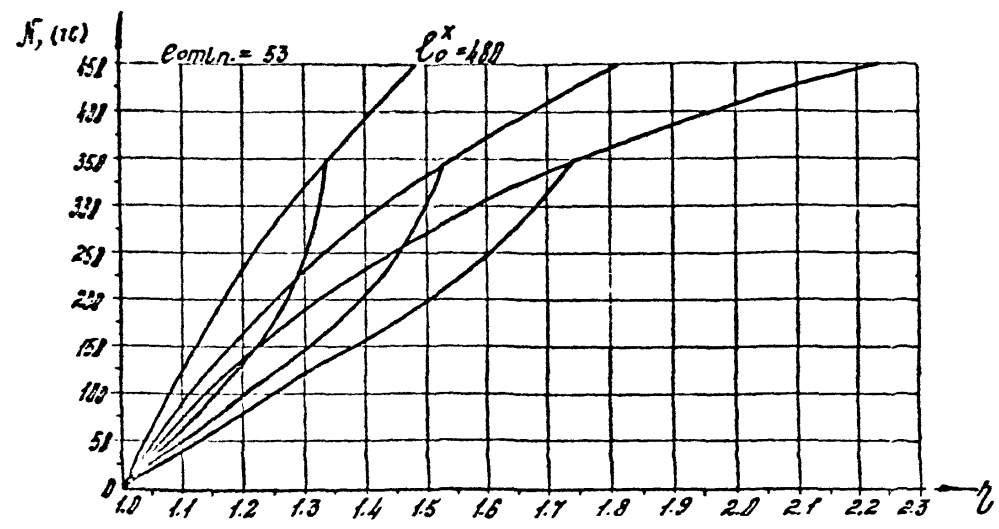

Box 32829 2.145

1020-1/57. 0-5- 3 113

168

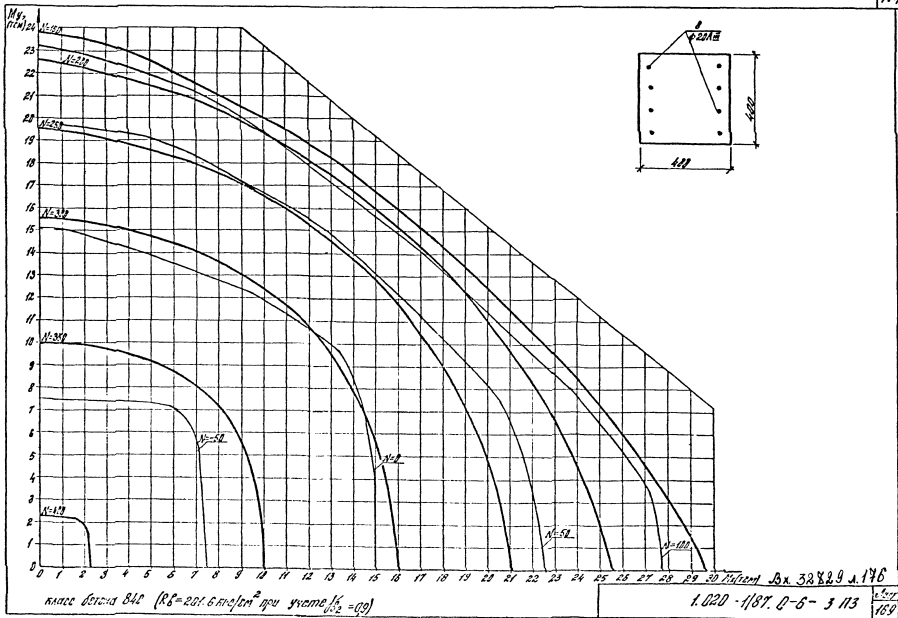

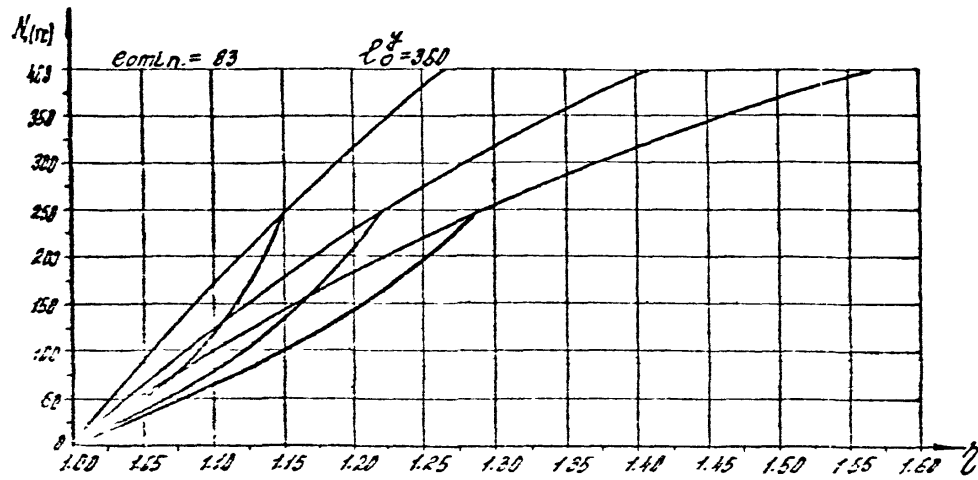
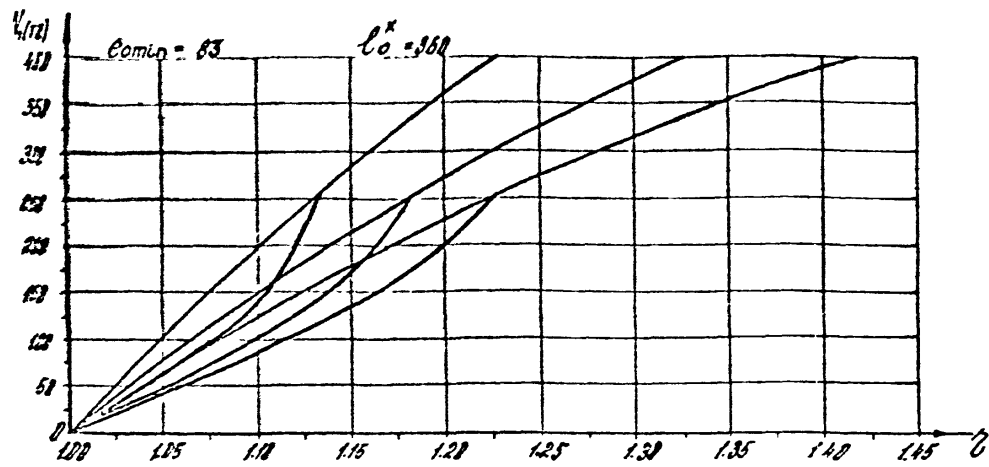

Box 54829 A. 177

1020-1/87.0-6-3 113

175

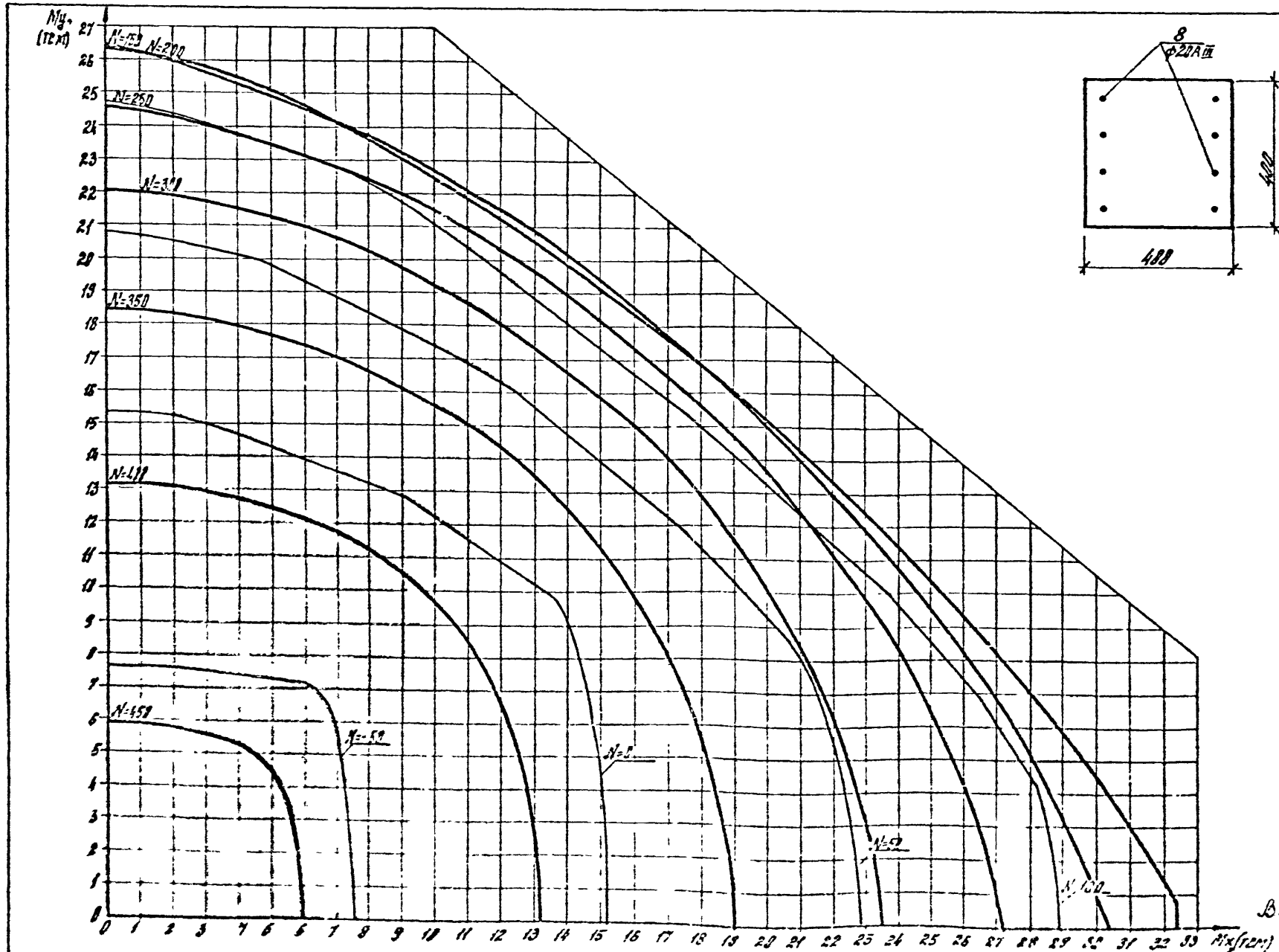

класс бетона В40 ($R_b = 24.6 \text{ кН/см}^2$ при учете $\gamma_c = 1.10$)

Вх. 32829 а. 178

1.020-1/97. 0-6-3 173

177

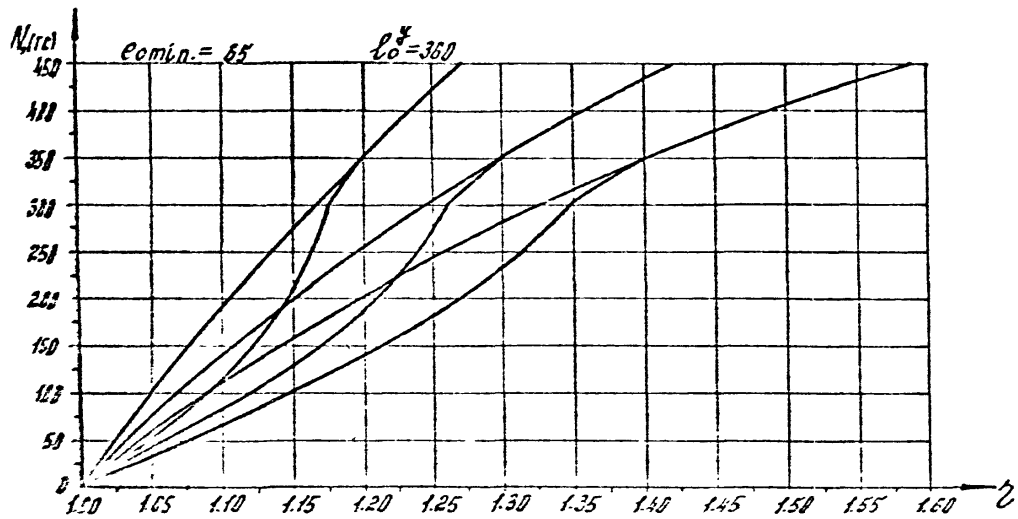
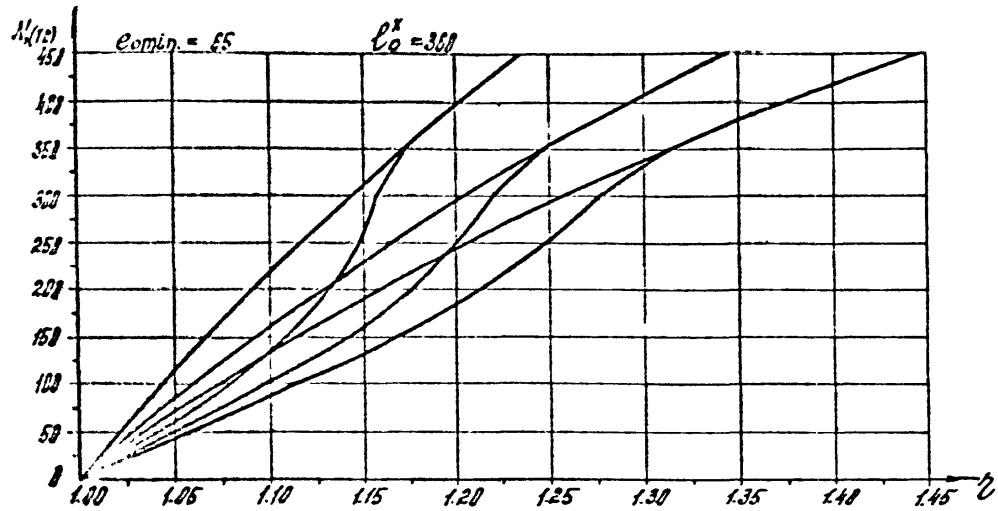

Box 36829 A. 149

1.020-1/87.0-6-3173

172

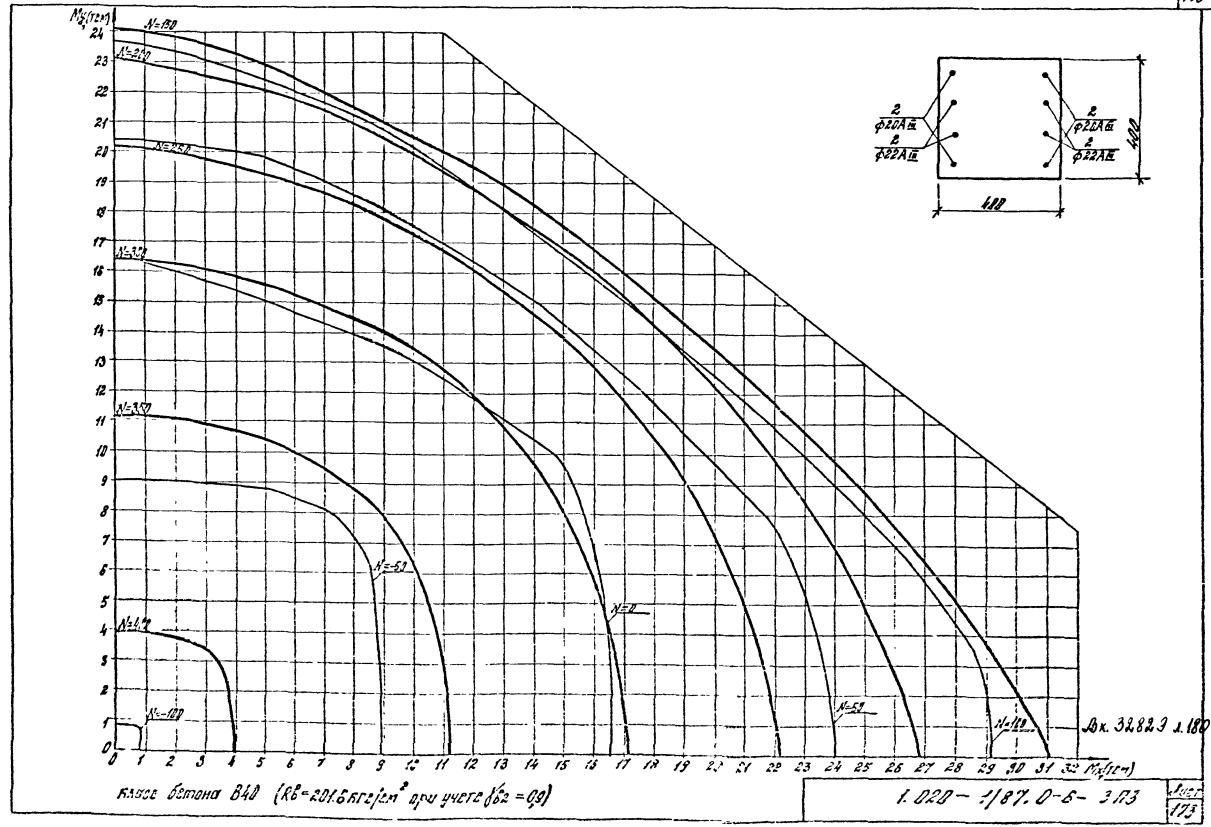

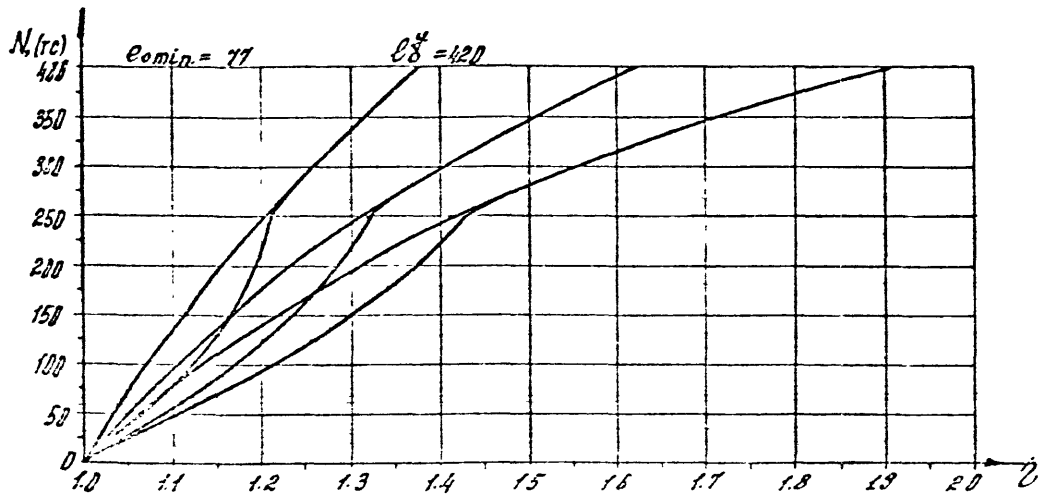
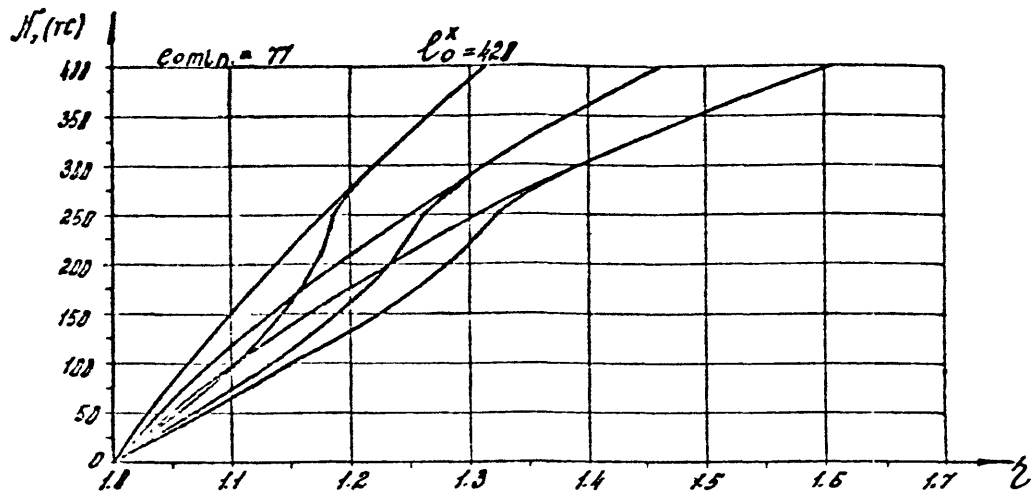

Box 32x49 A.181

1.020-1/87.0-6-3 173

174

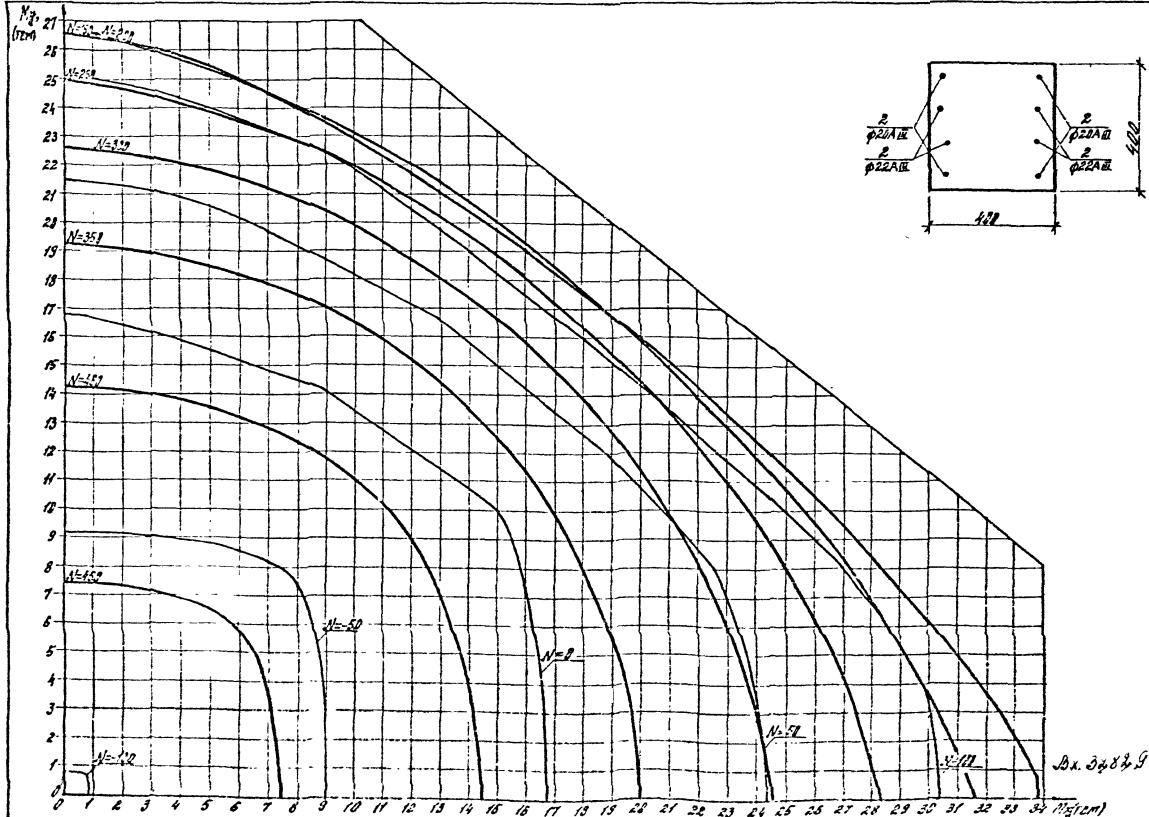

Вх. 34,875 м

класс бетона В40 ($R_B = 24,4 \text{ кПа/см}^2$ при учете $\gamma_c = 1,10$)

1020-1/87 0-5-3113

лист 1/13

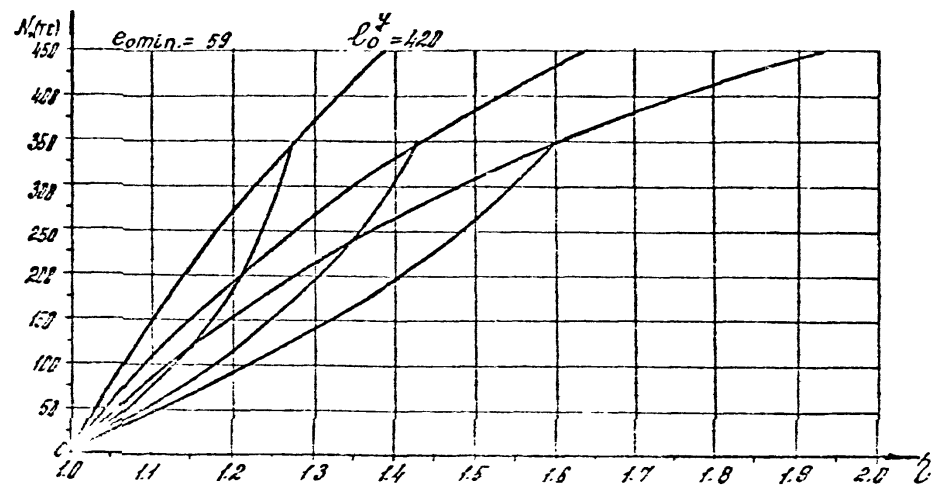
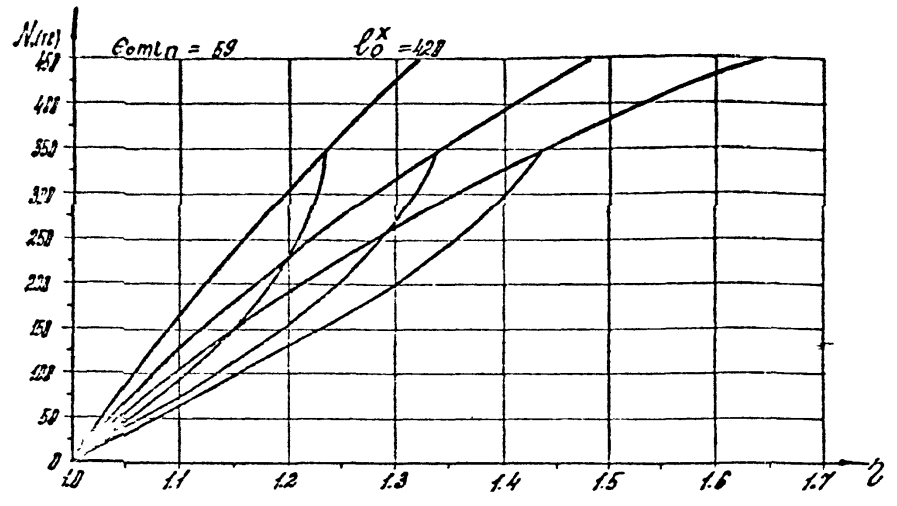

Bx 32829 a.183

1.020-1/87. D-6-373

176

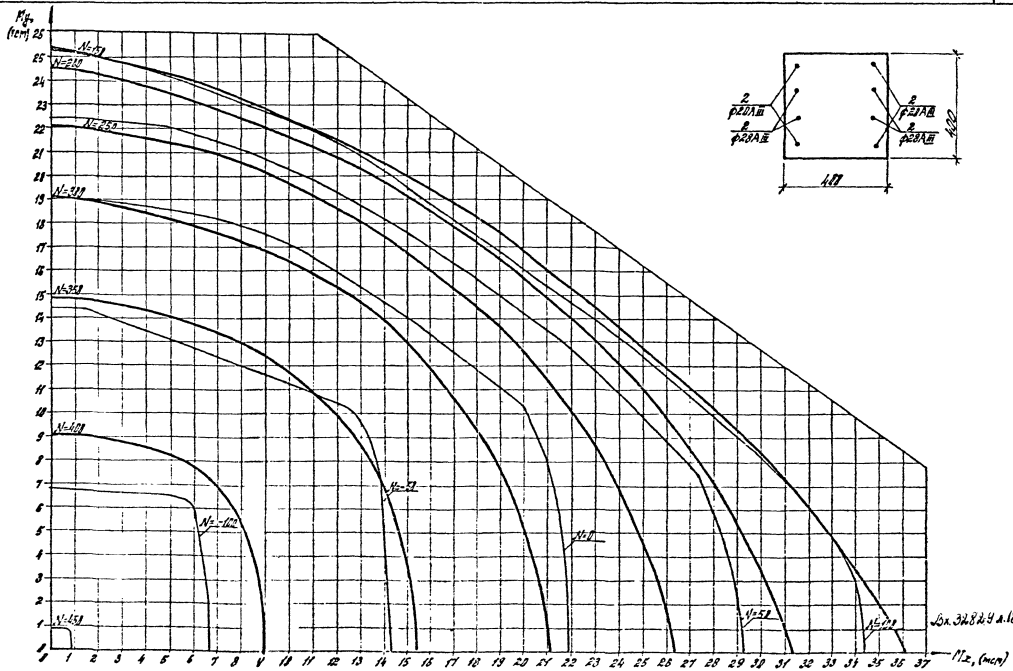

класс бетона B40 ($R_b = 20.1 \text{ МПа}$; $\sigma_{ct} = 0.9$)

1.020-1/87. D-5-3/13

См. 32.8.4. а. 104

177

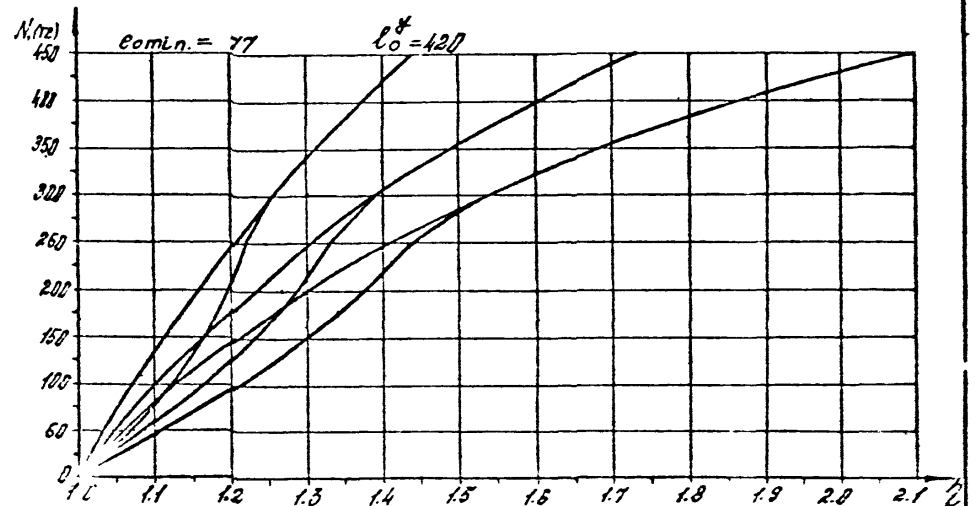
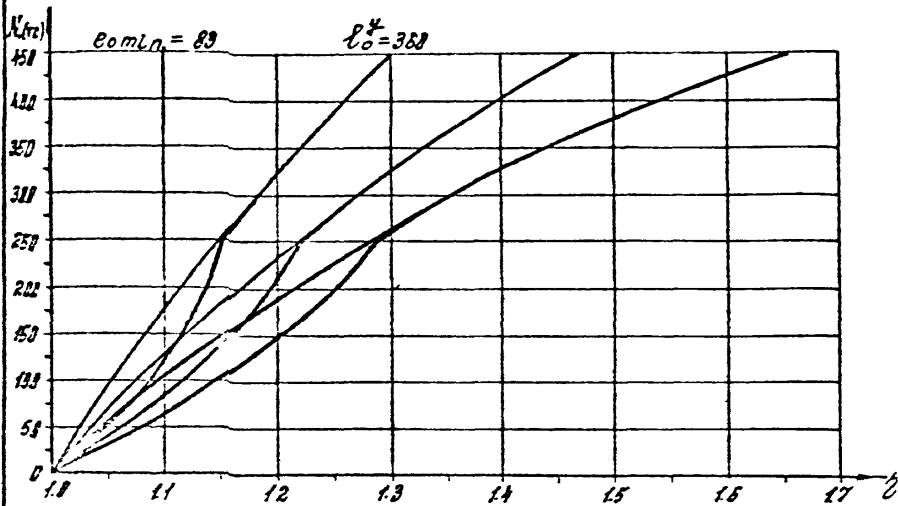
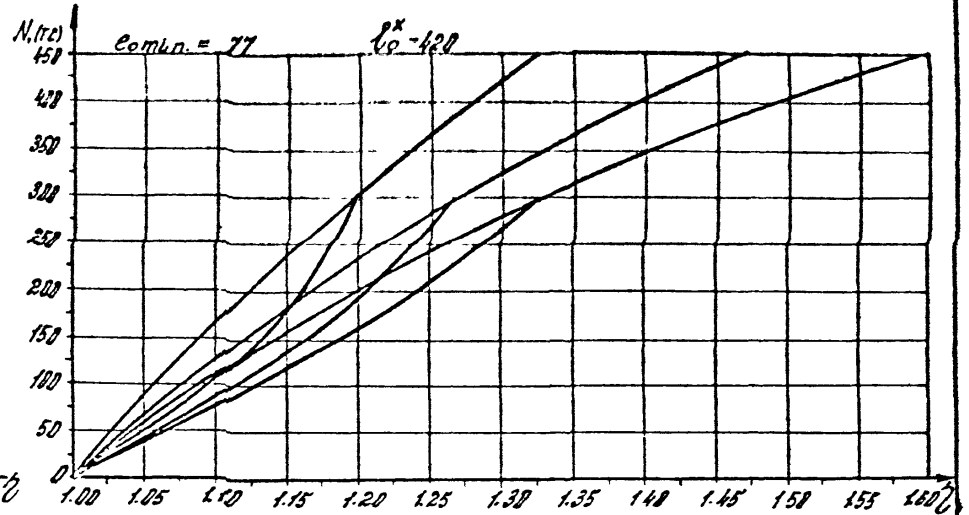
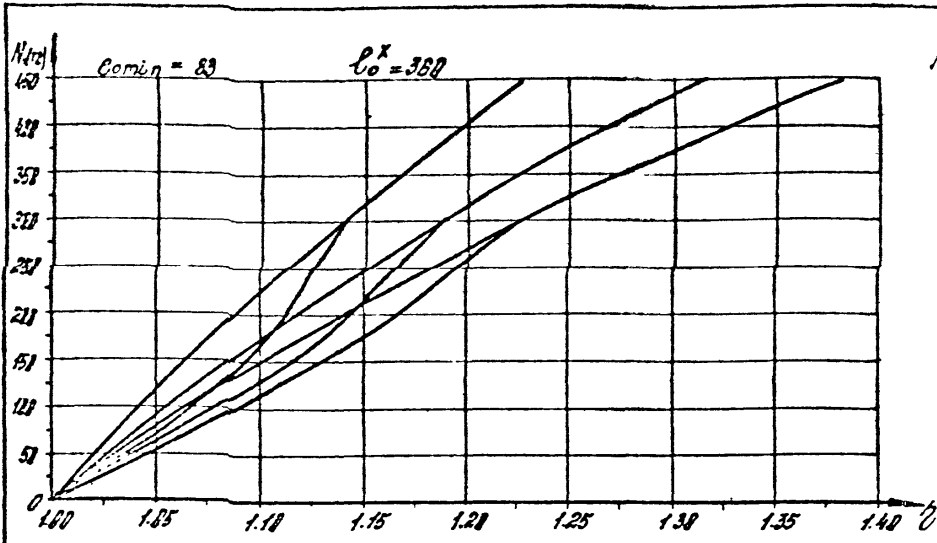

Bx 32829 A.185

1.020-1/87.0-6-313

aver
178

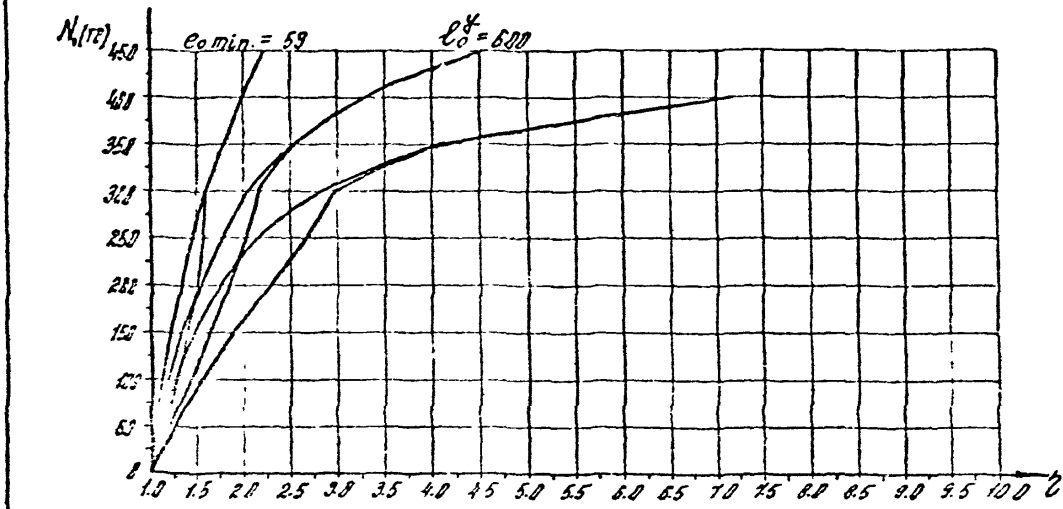
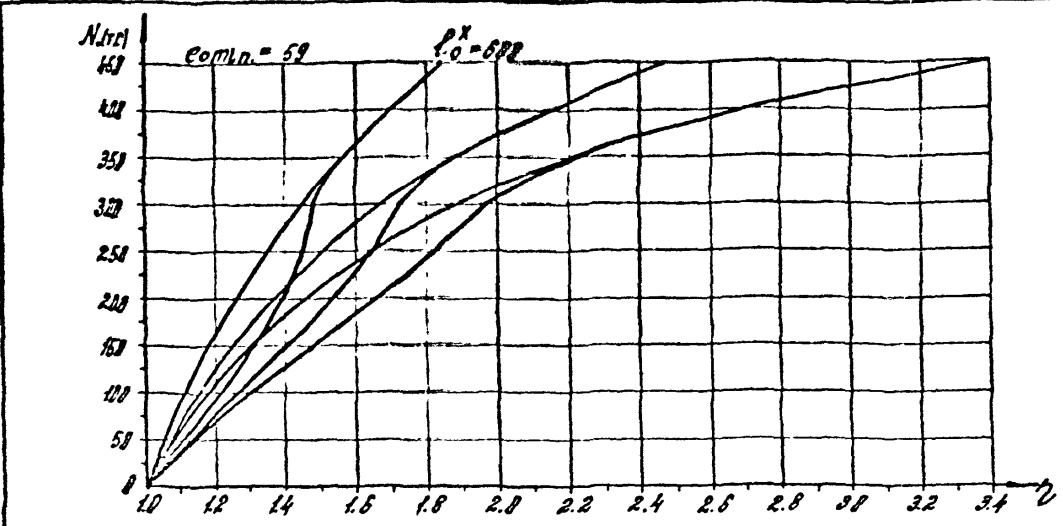

Bx 32829 J.186
1.020-1/87. 0-5-373
119

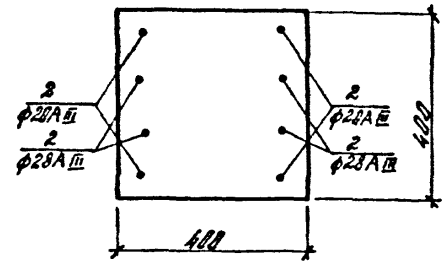
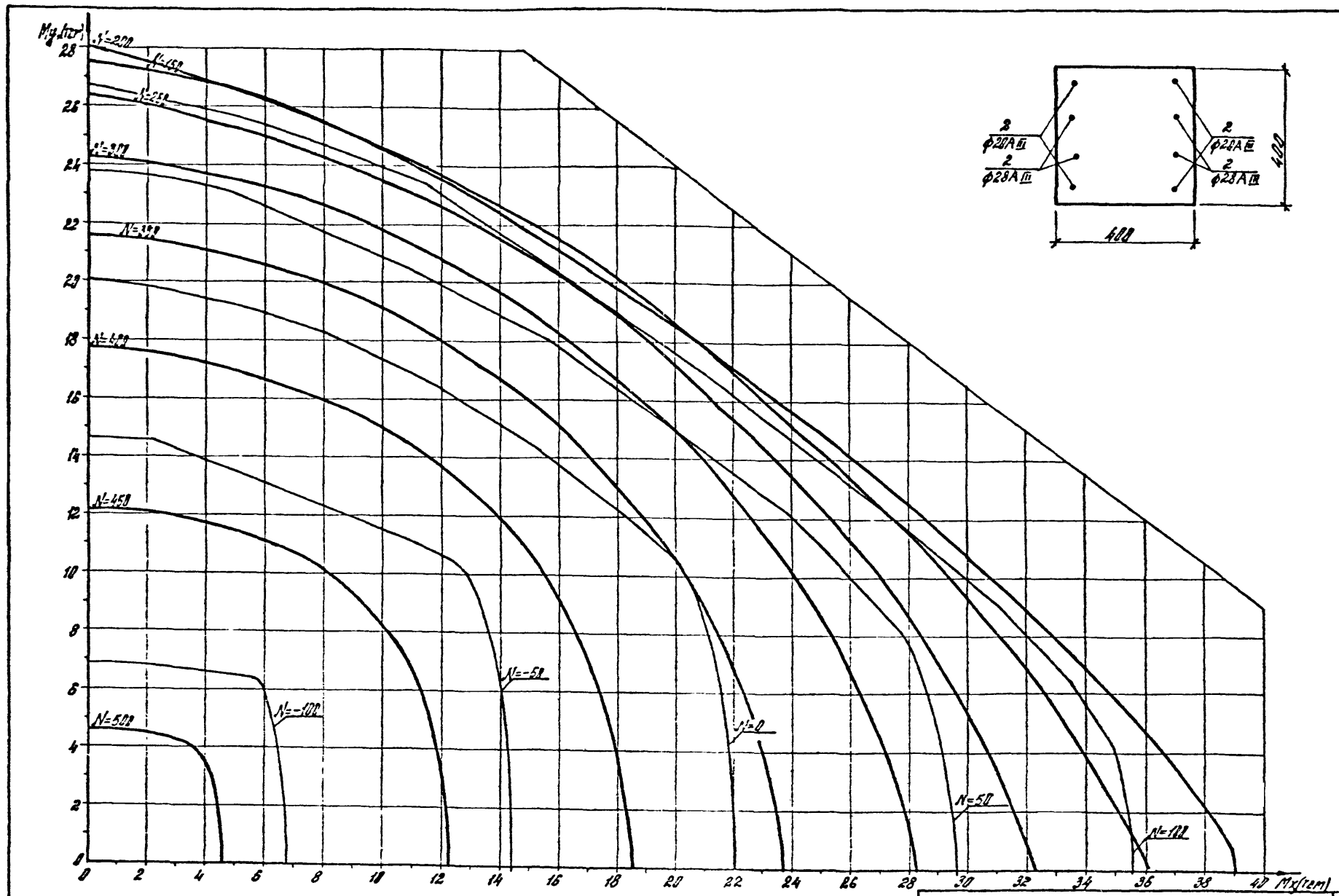

класс бетона В40 ($R_b = 24.6 \text{ кН/см}^2$ при учете $\gamma_{b2} = 1.10$)

1.020-1/87. 0-6 - 3.173

лист
180

Вх. 32829 л. 187

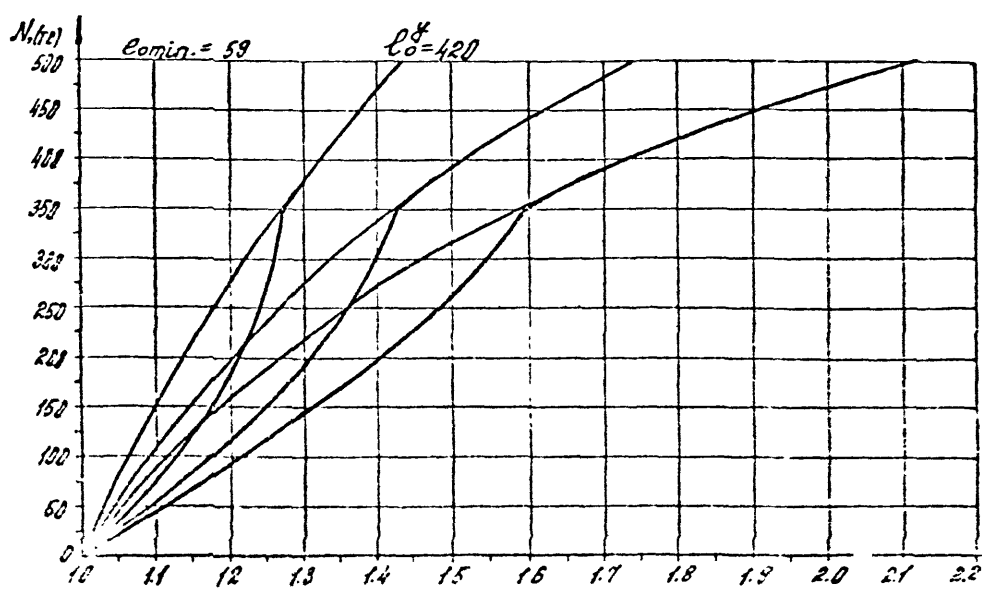
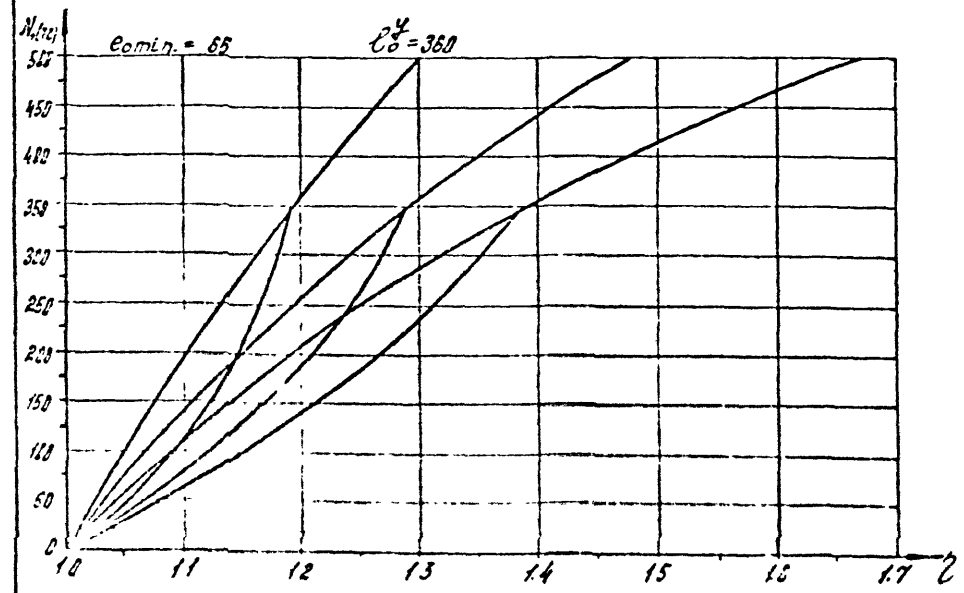
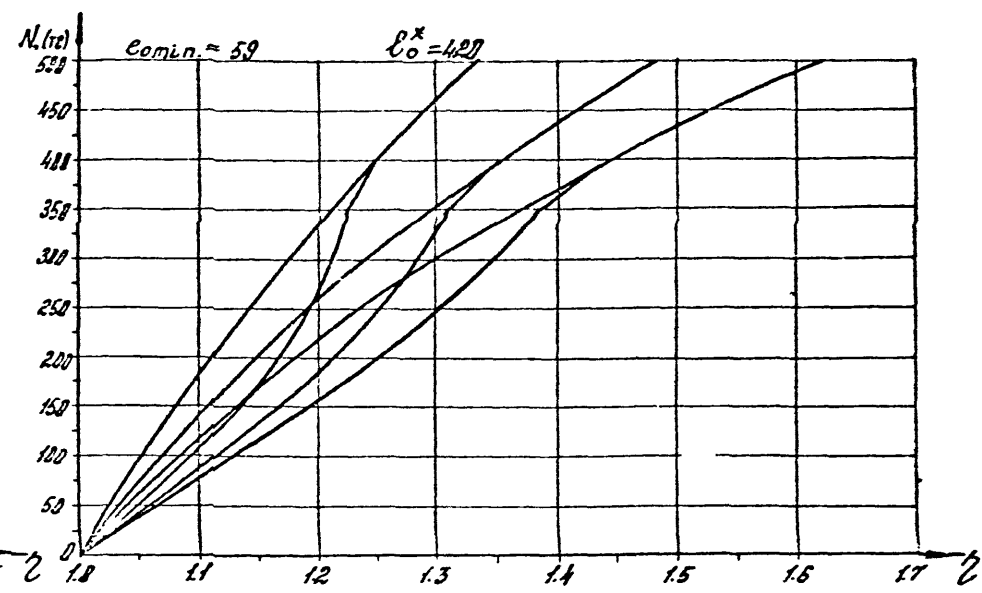
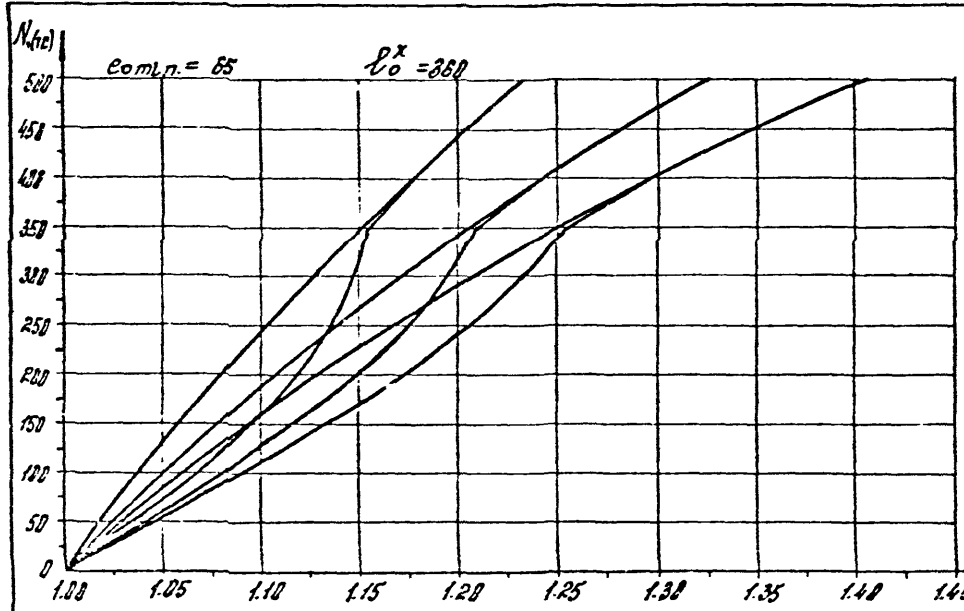

1020-1/87. 0-6-3 173

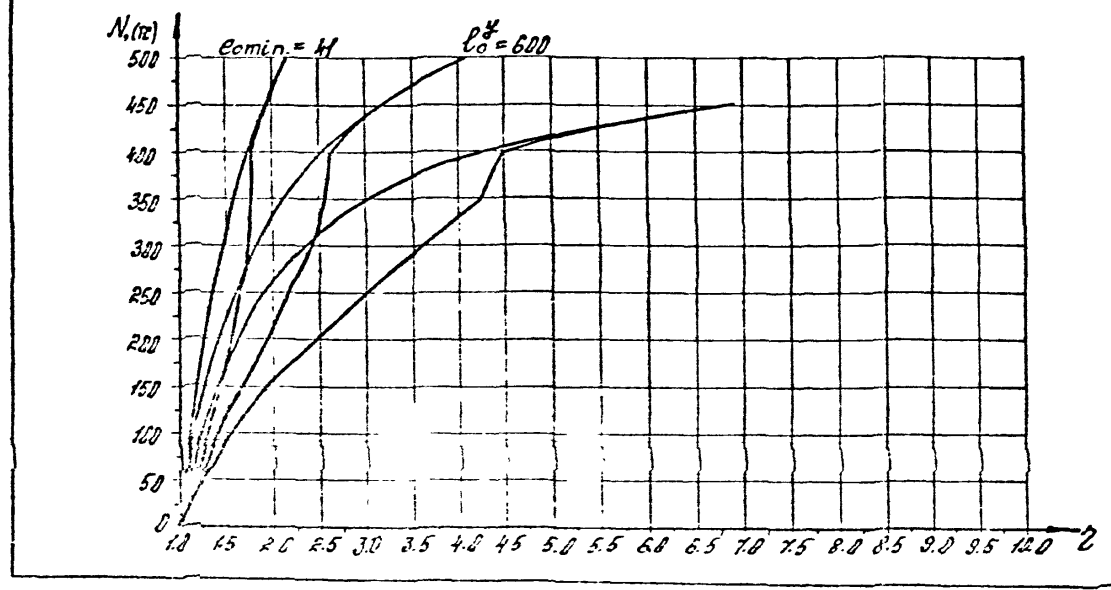
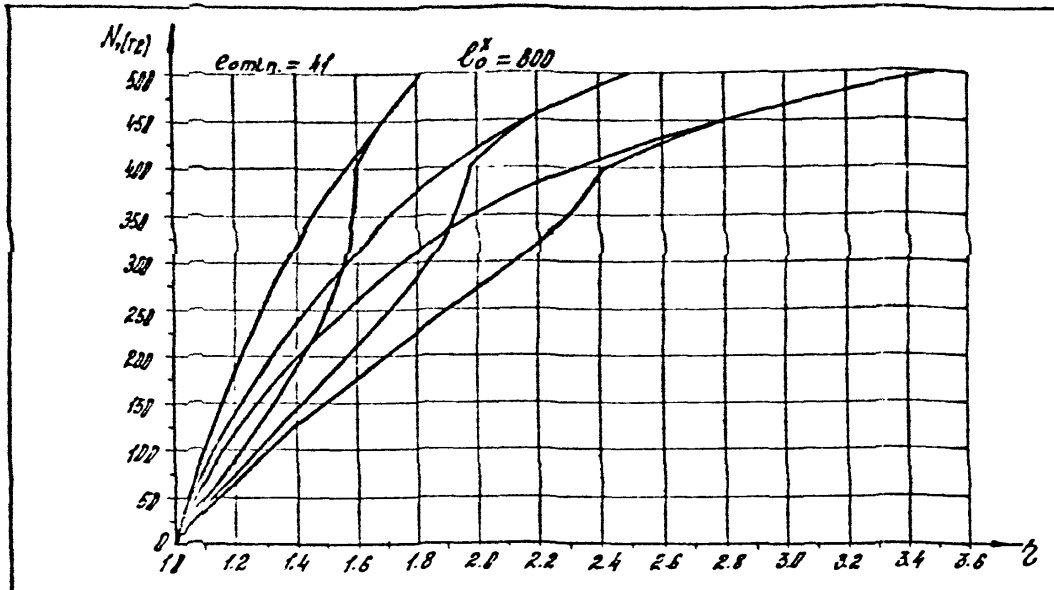

Box 32829 J. 189
1.020-1/87.0-6-373
182

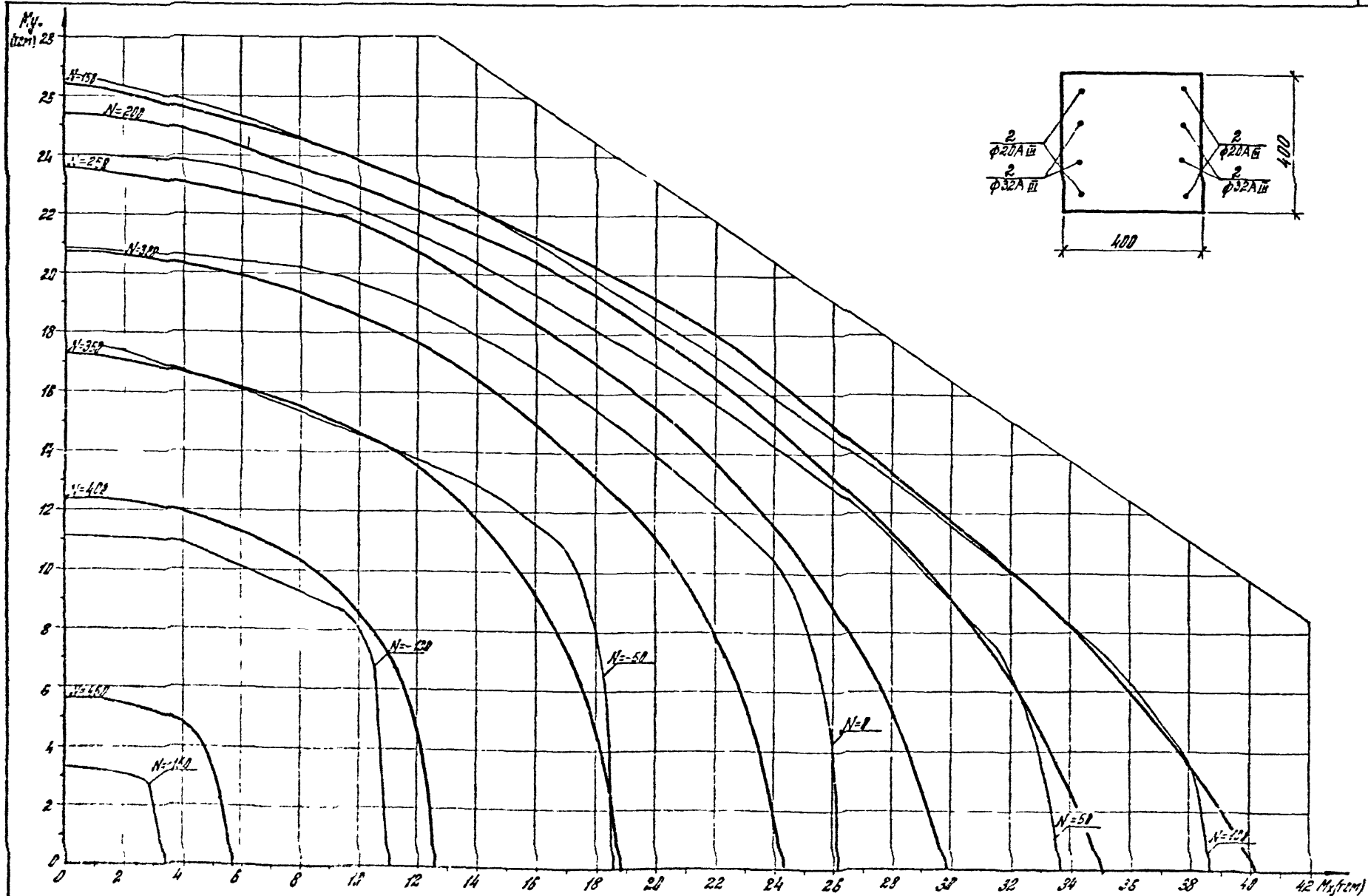

РАСЧЕТ СЕКЦИОНА Б42 ($R_b = 20151 \text{ кг/см}^2$ и $R_{sc} = 34000 \text{ кг/см}^2$) ($\beta_2 = 0,9$)

1.020-1/87. 0-6- 3 П3

Бх. 32.829 л. 190

185

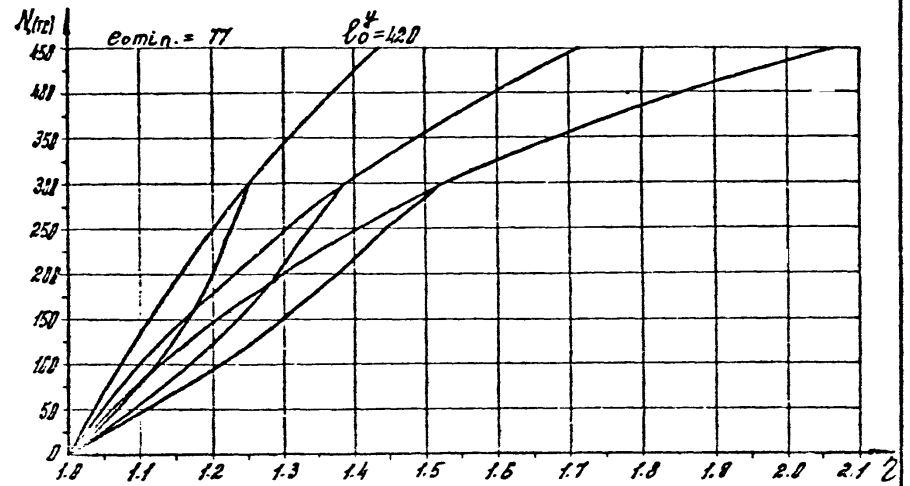
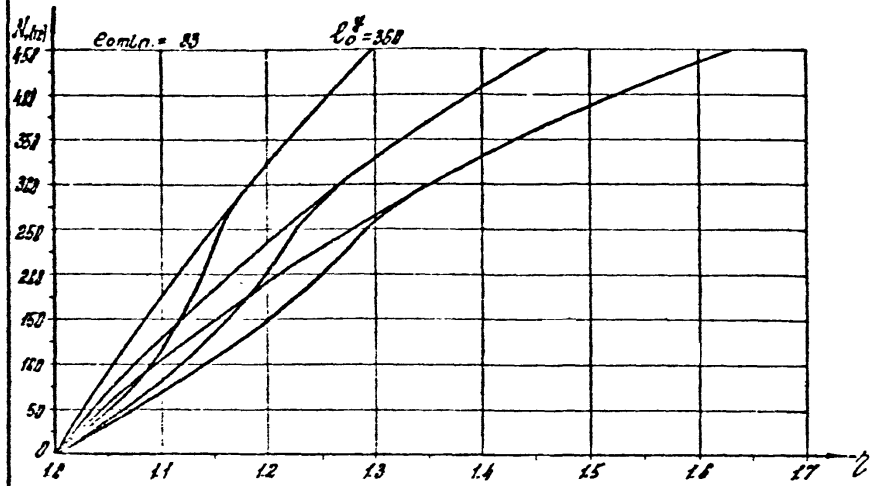
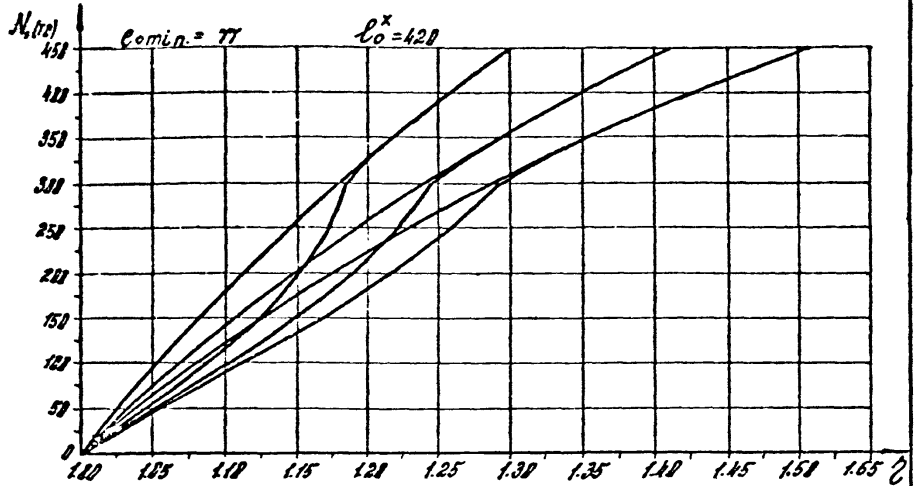
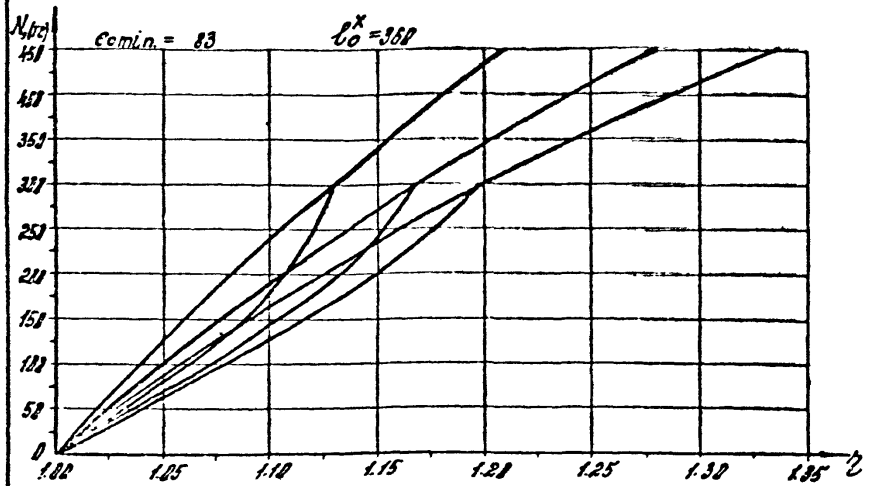

Bx 32829 J.191

1.020. - 1/87.0-5-373

184

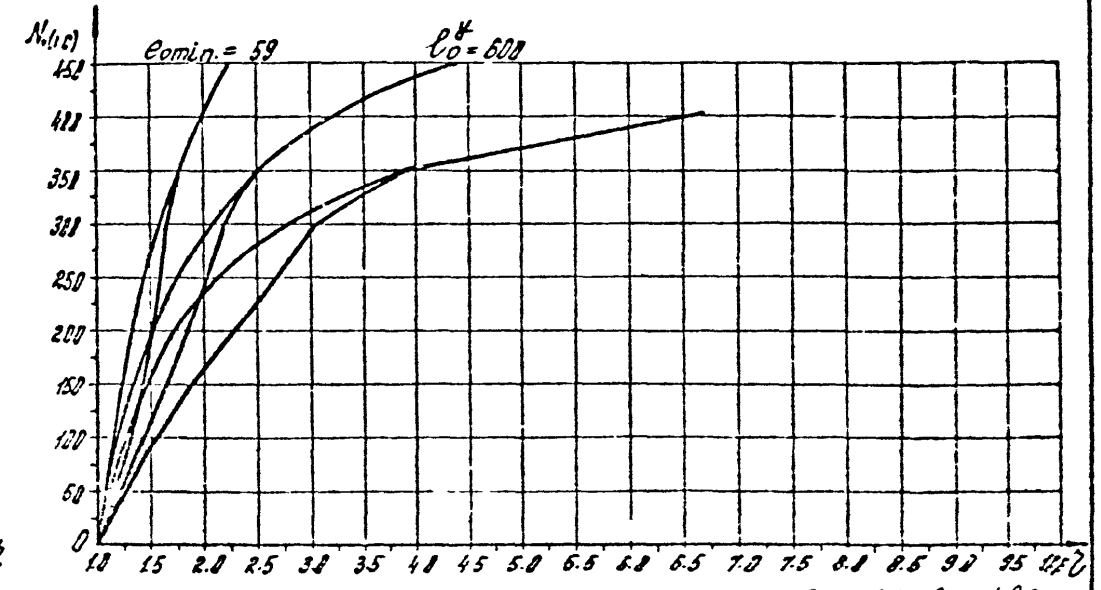
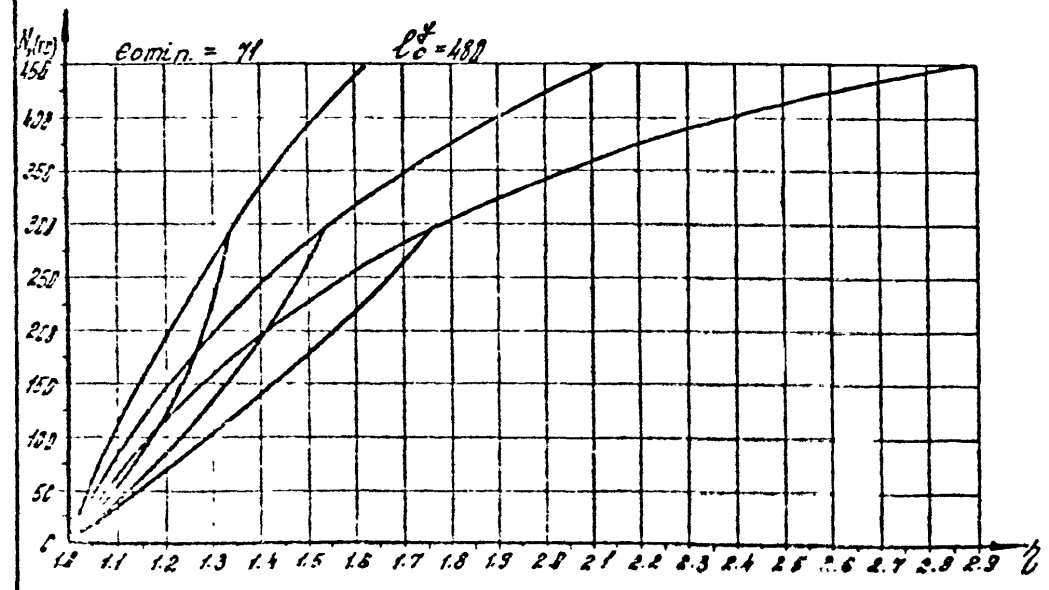
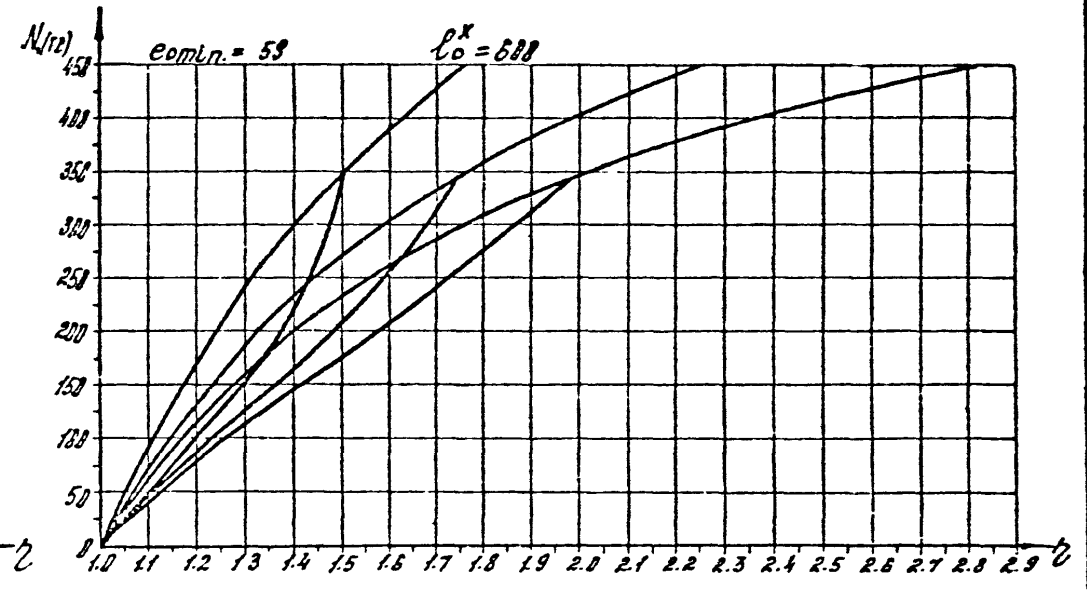
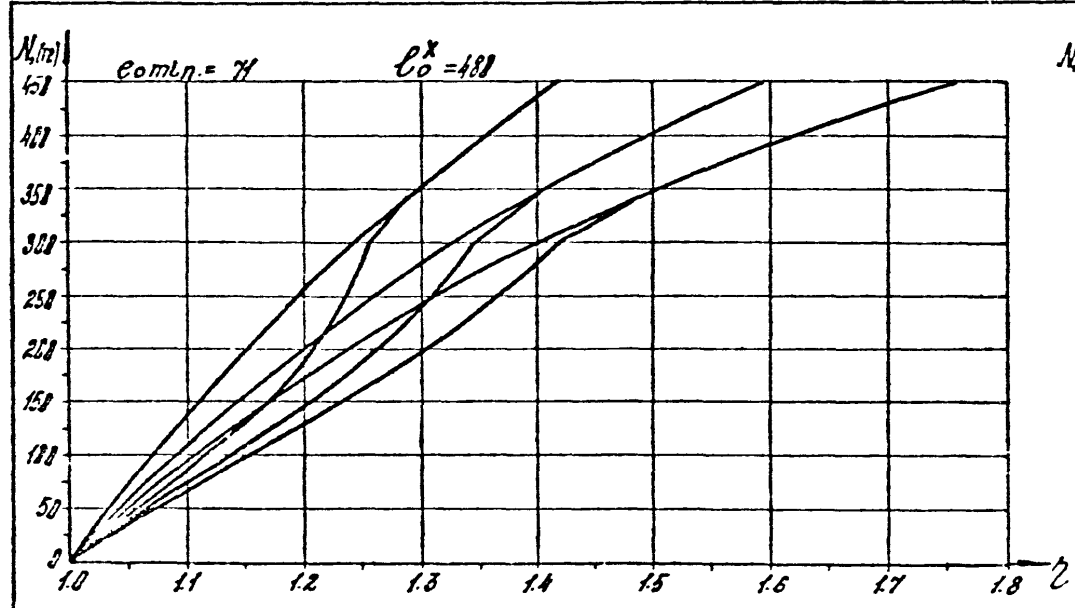

Dr. 32829 A. 192

1.020-1.87.0-5-3173	187 185
---------------------	------------

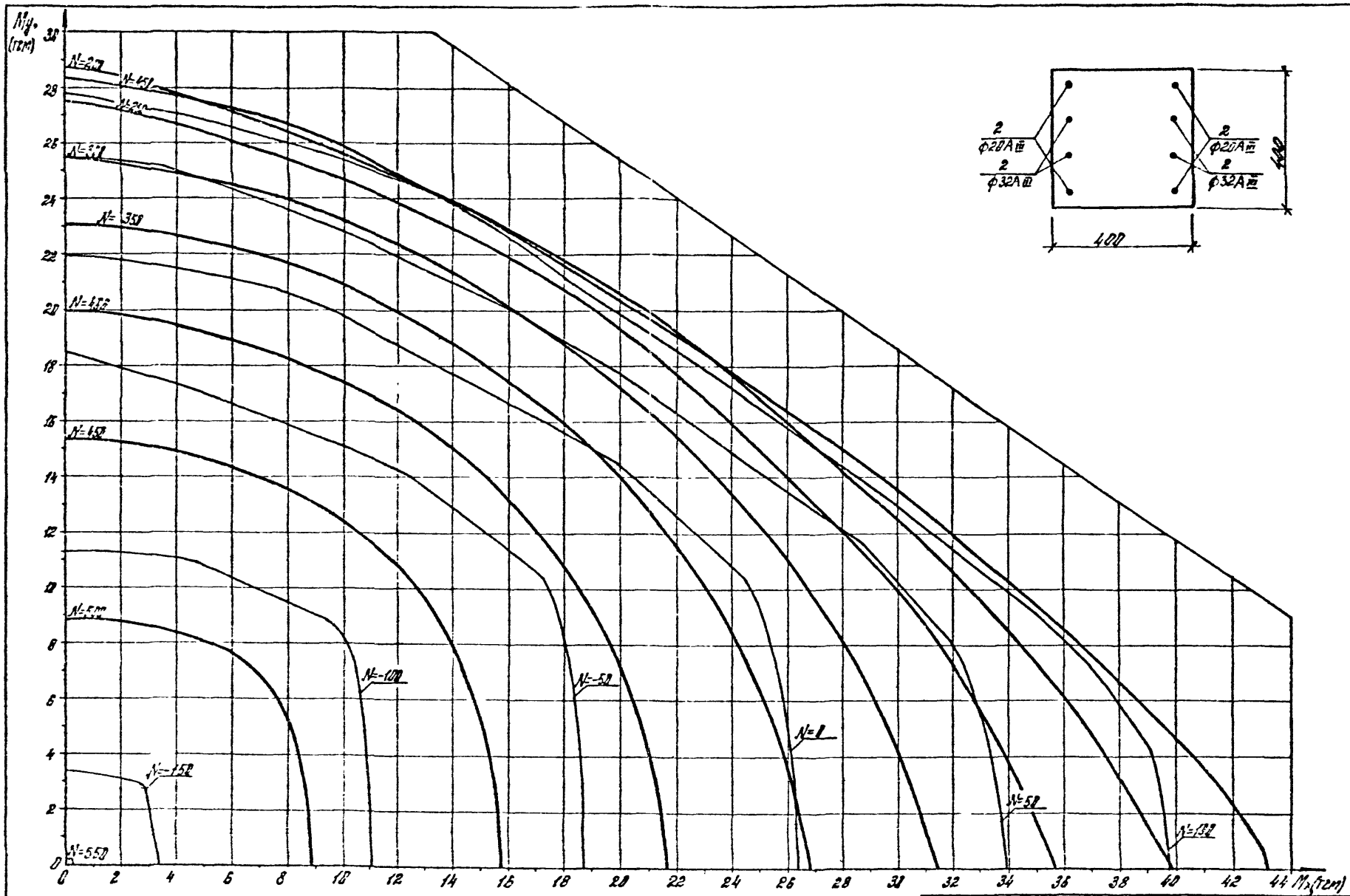

Класс бетона В40 ($R_b = 24.6, 4.6 \text{ т/см}^2$ при $\gamma_{bz} = 1.10$)

1.020.-1/87 Д-6-313

Вх. 32829 д. 193

лист
196

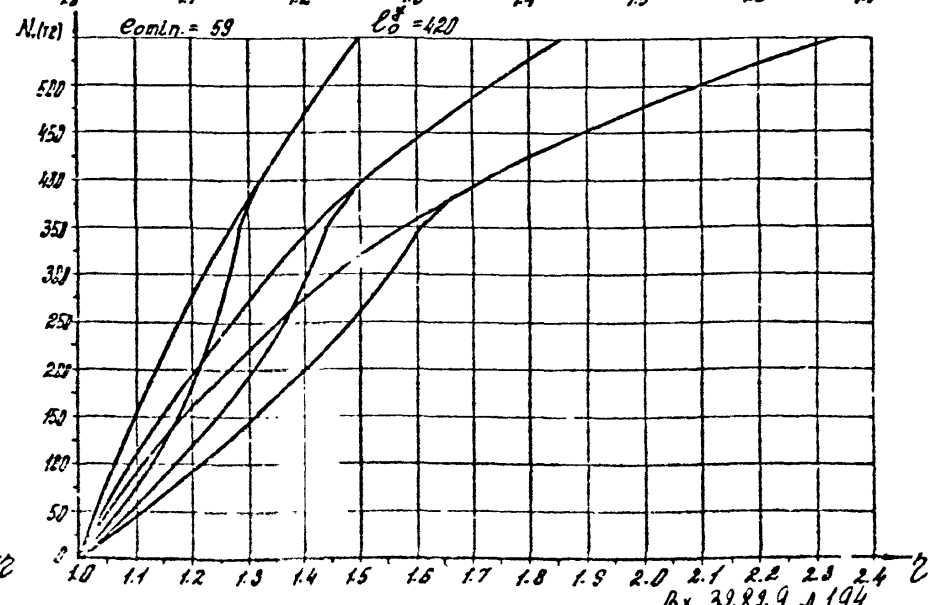
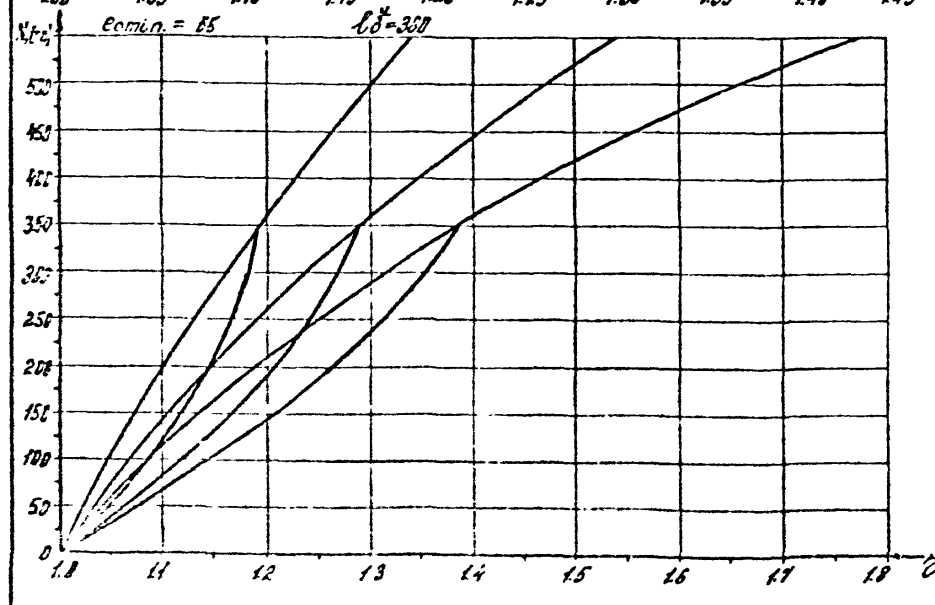
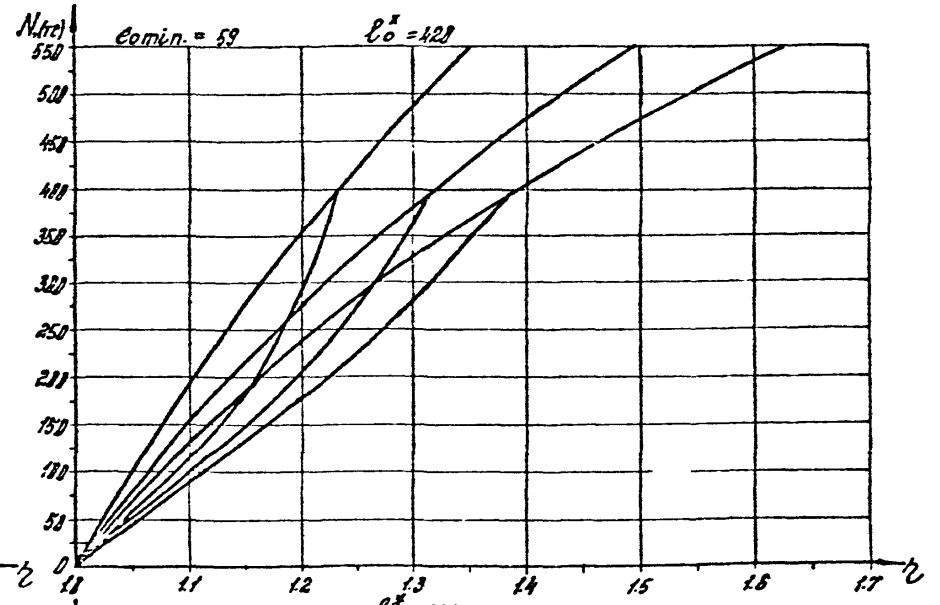
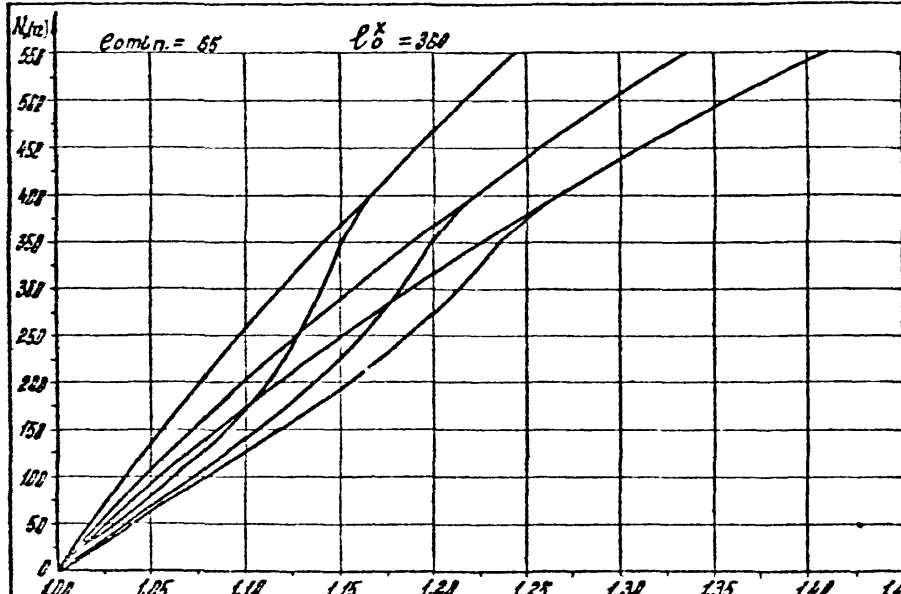

Bx. 32829 A.194

1.020-1/87. 0-6- 313

Sheet 187

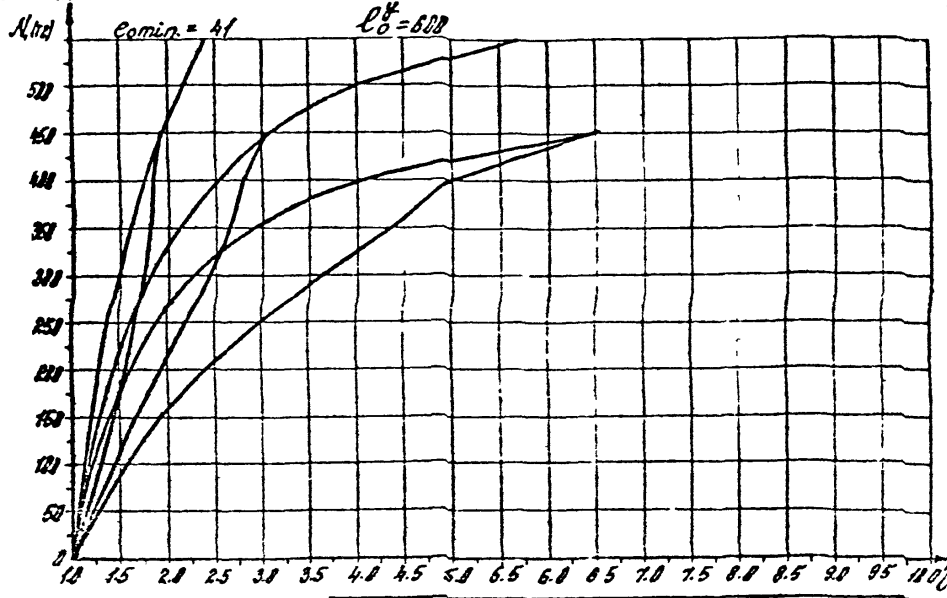
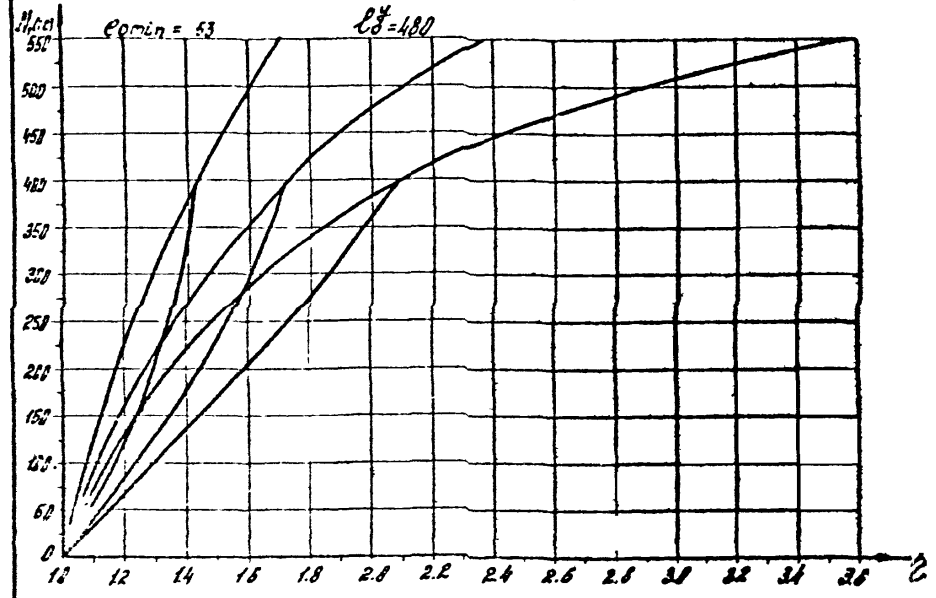
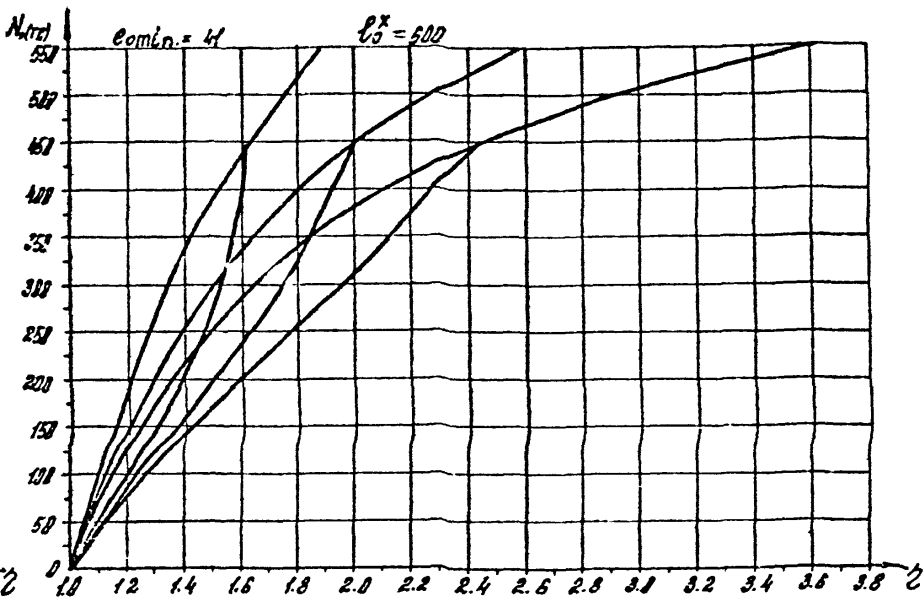
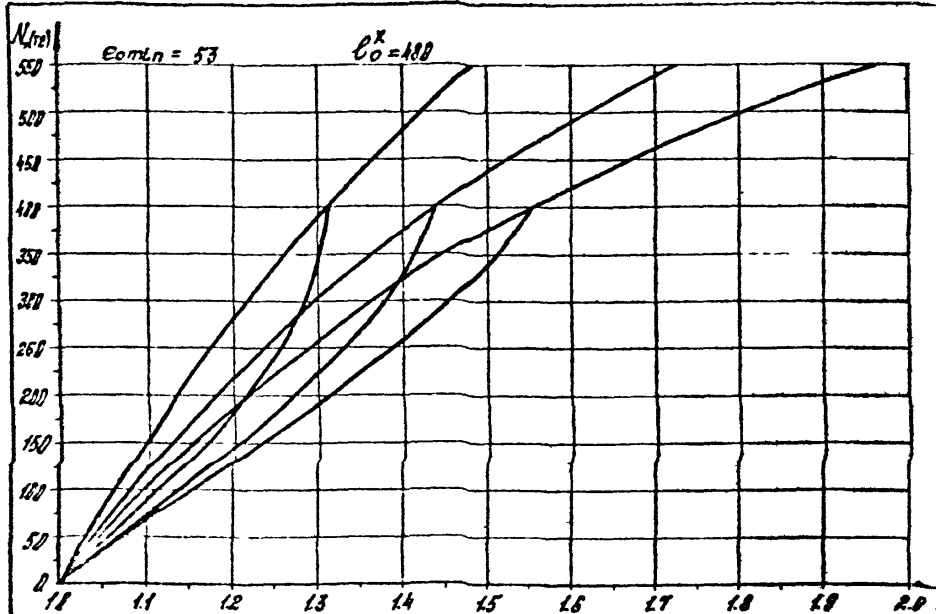

1.020-1/87.0-6-313

Bx. 30x49 A. 135

188

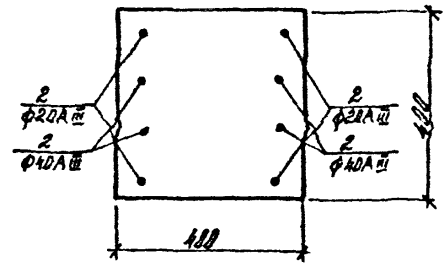
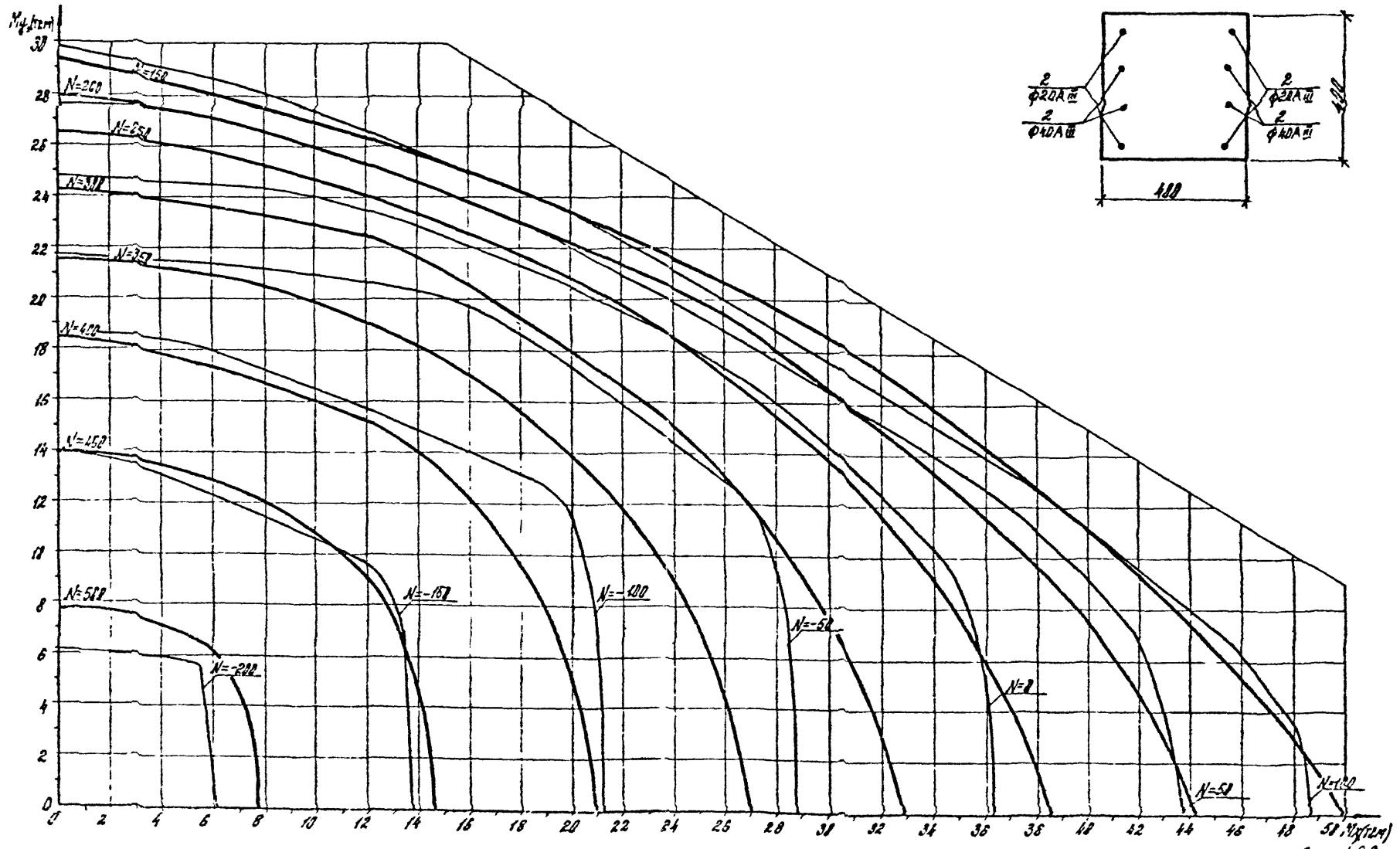

класс бетона В40 ($R_b = 201.6 \text{ МПа}$ при учете $\gamma_b = 0.9$)

Дх. 3282.9 д. 196

1.020-1/87.0-6-373 лист
18.9

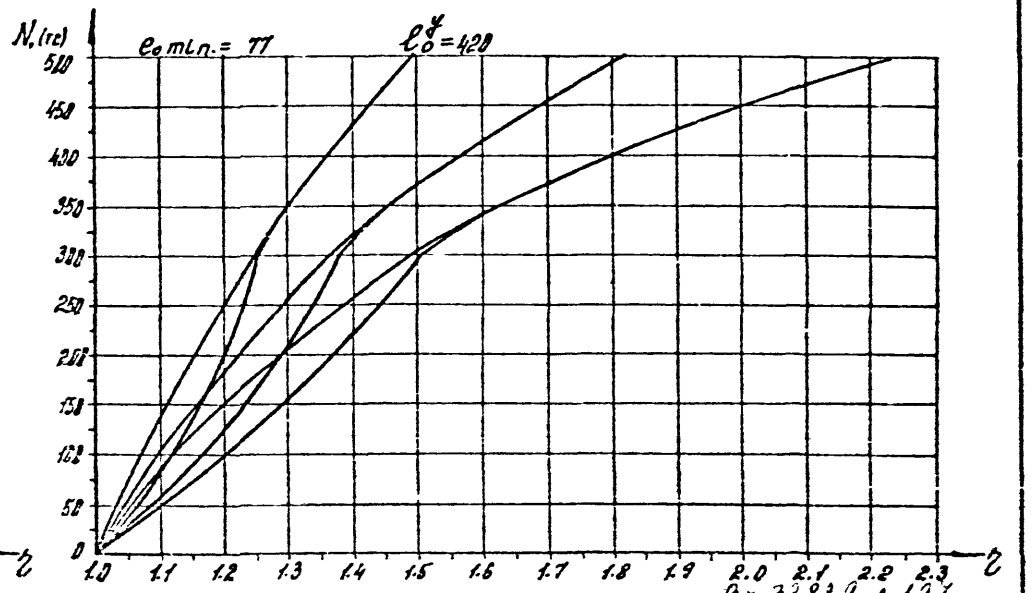
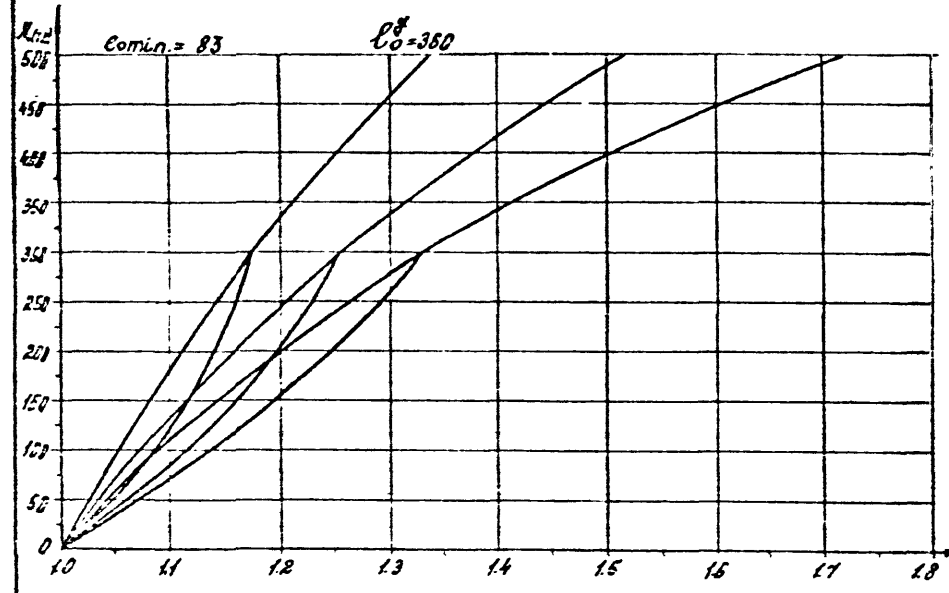
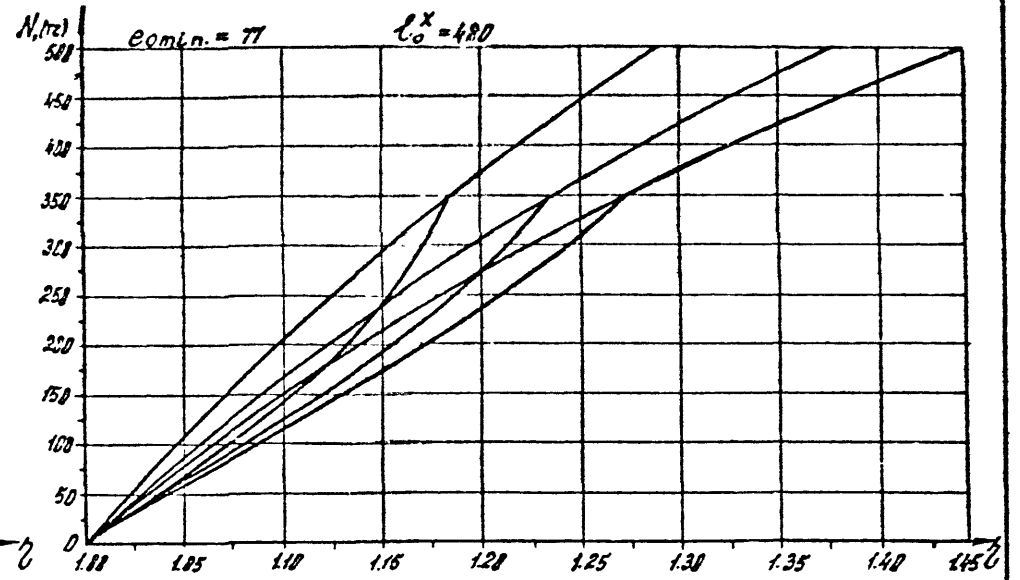
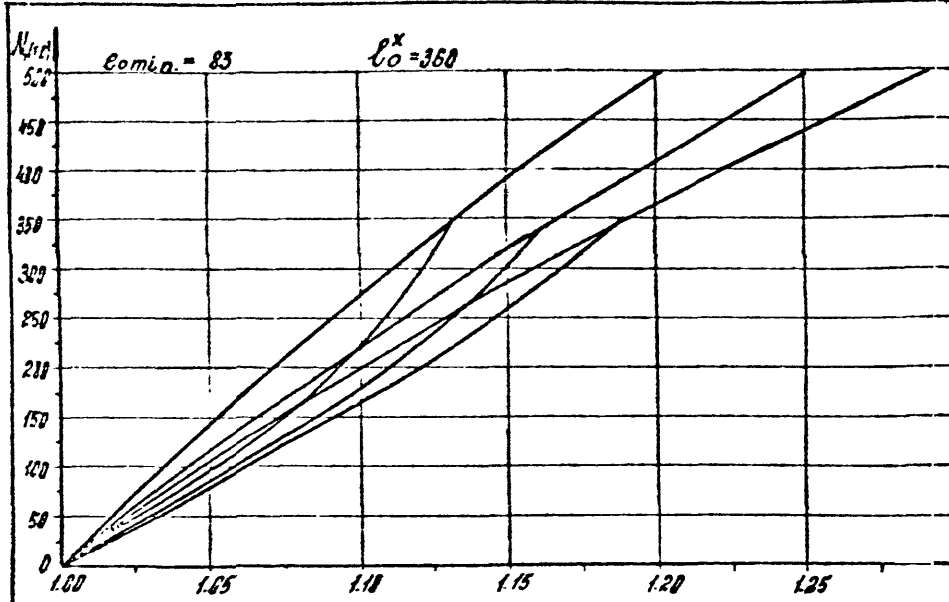

Box 32829 A. 197

1.020-1/87.0-6-3173

190

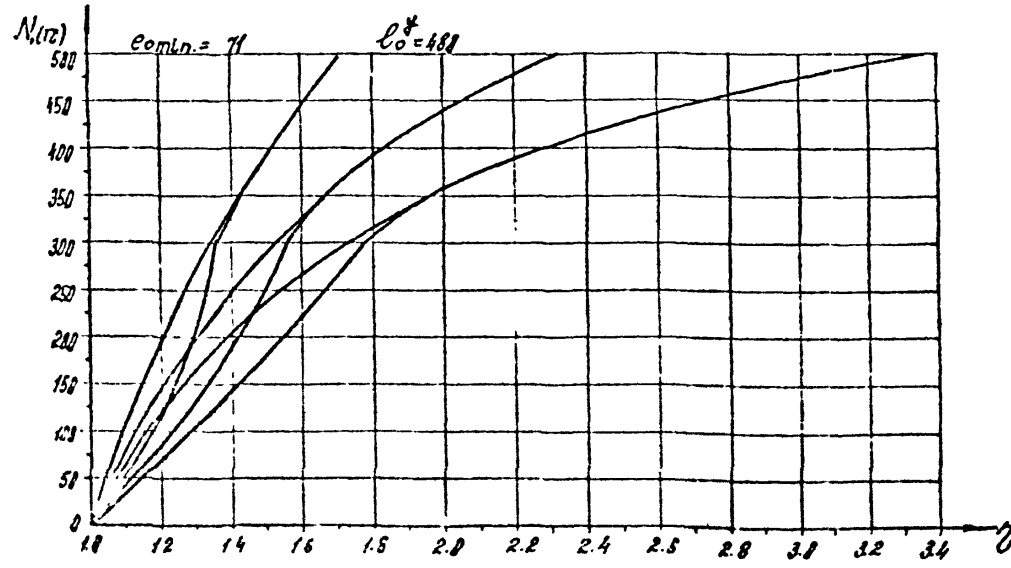
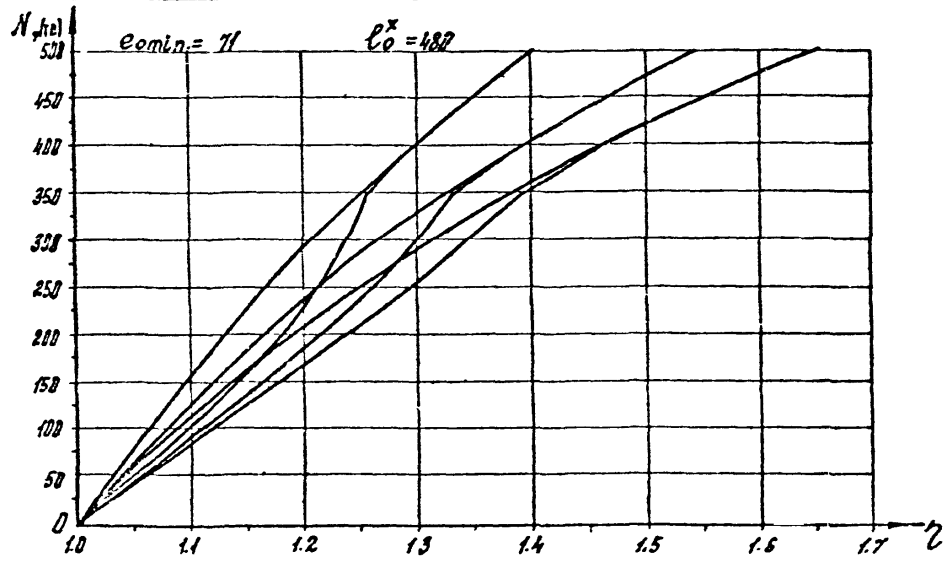

Bx. 32829 A. 198

1.020-1/87. 0-5- 3113

197
191

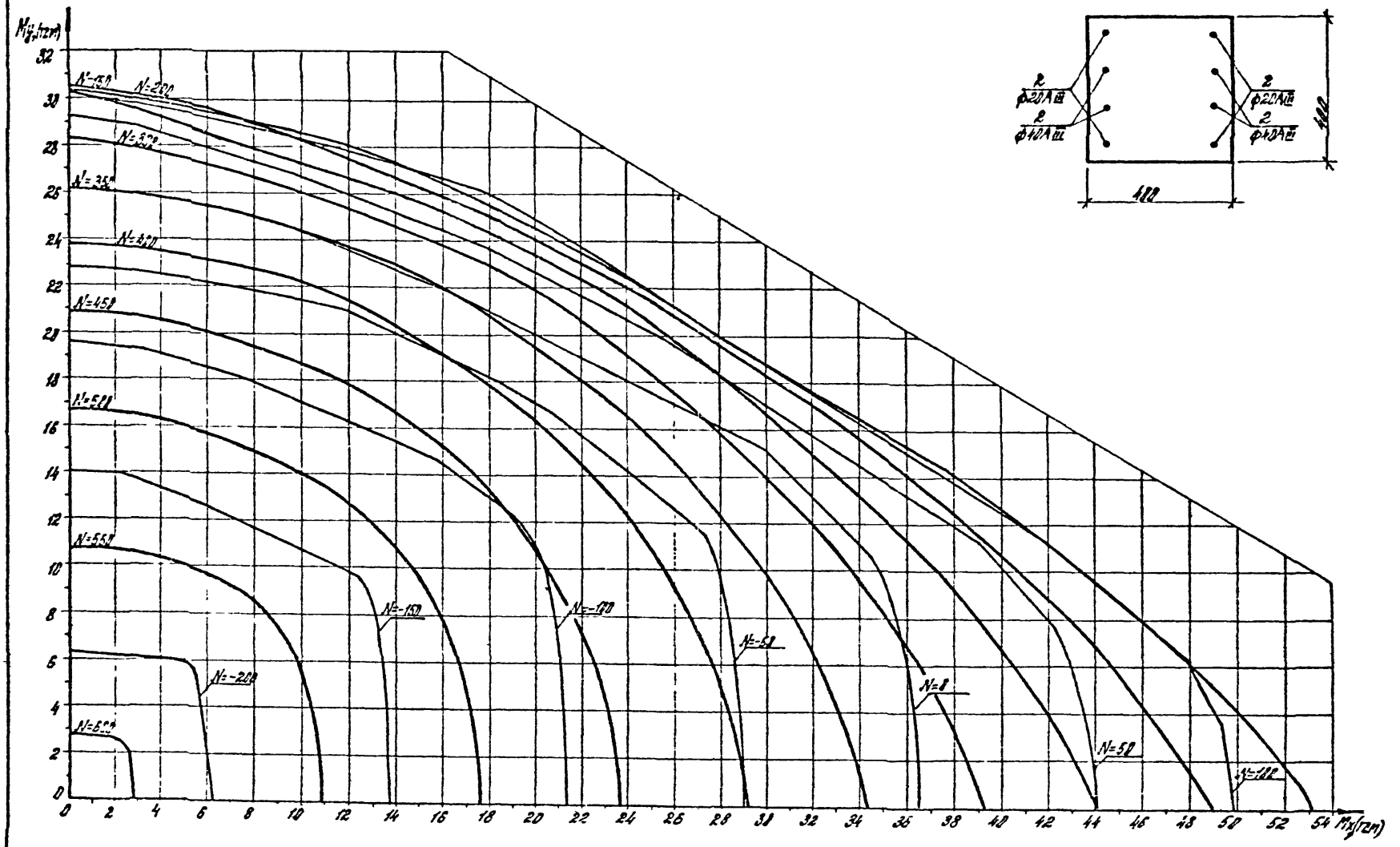

класс бетона В40 ($R_b = 24.6, 4.8 \text{ кН/см}^2$ при учете $\gamma_{b2} = 1.10$)

Дж. 32829 д. 199
1020-1/87. 0-6-3 173
192

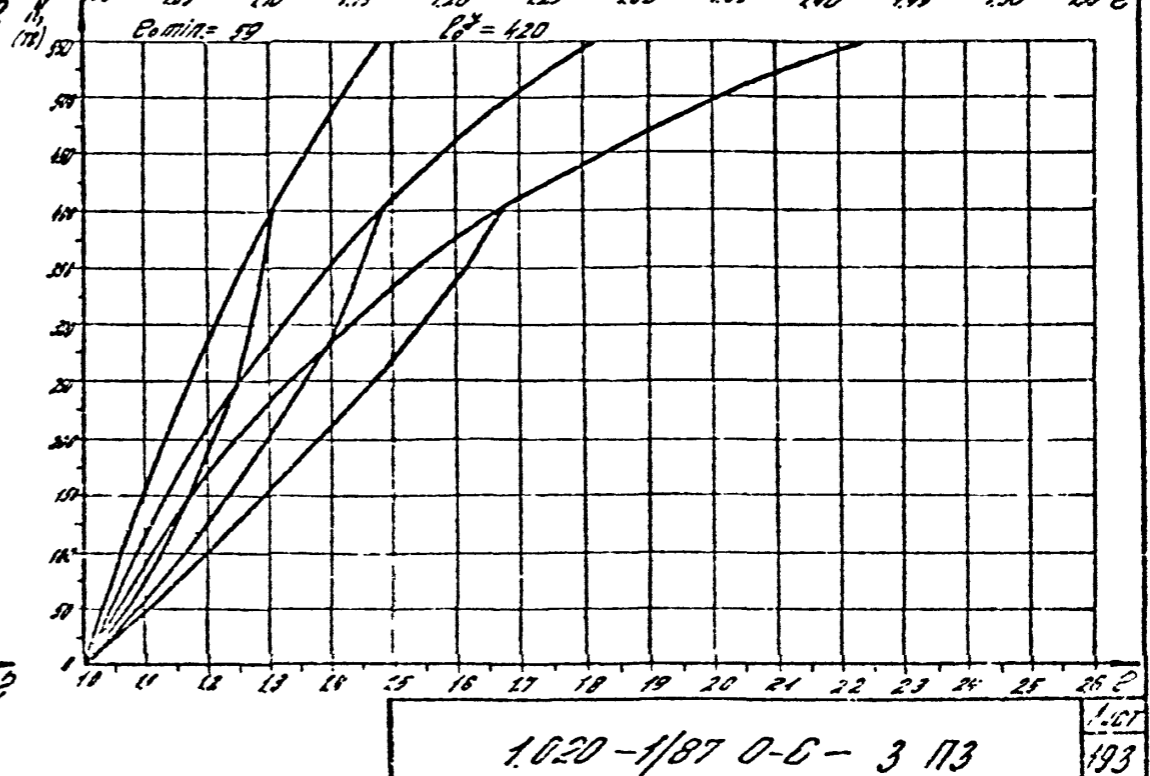
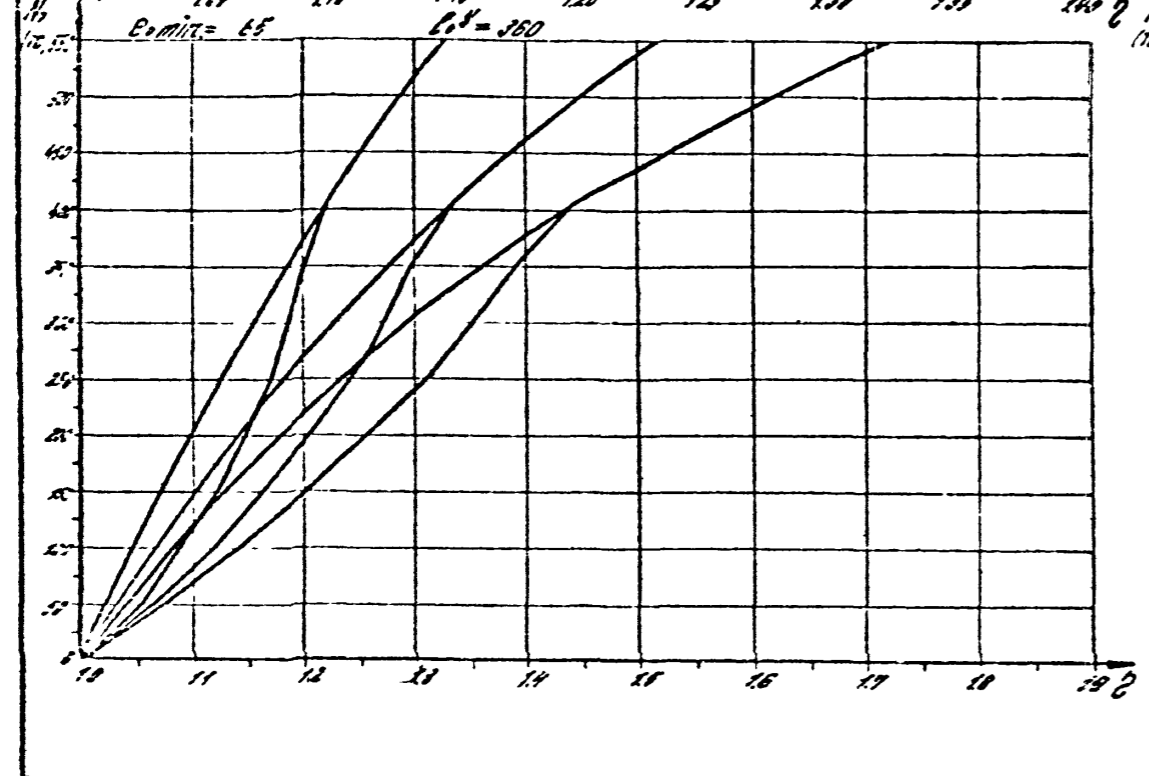
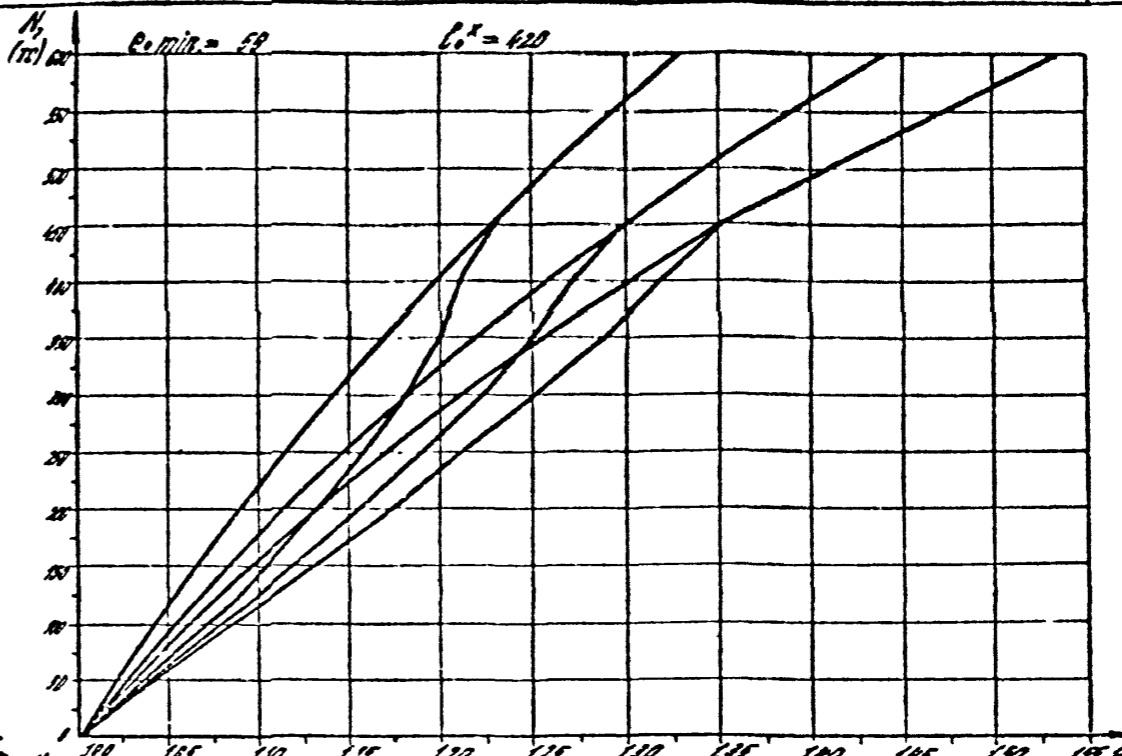
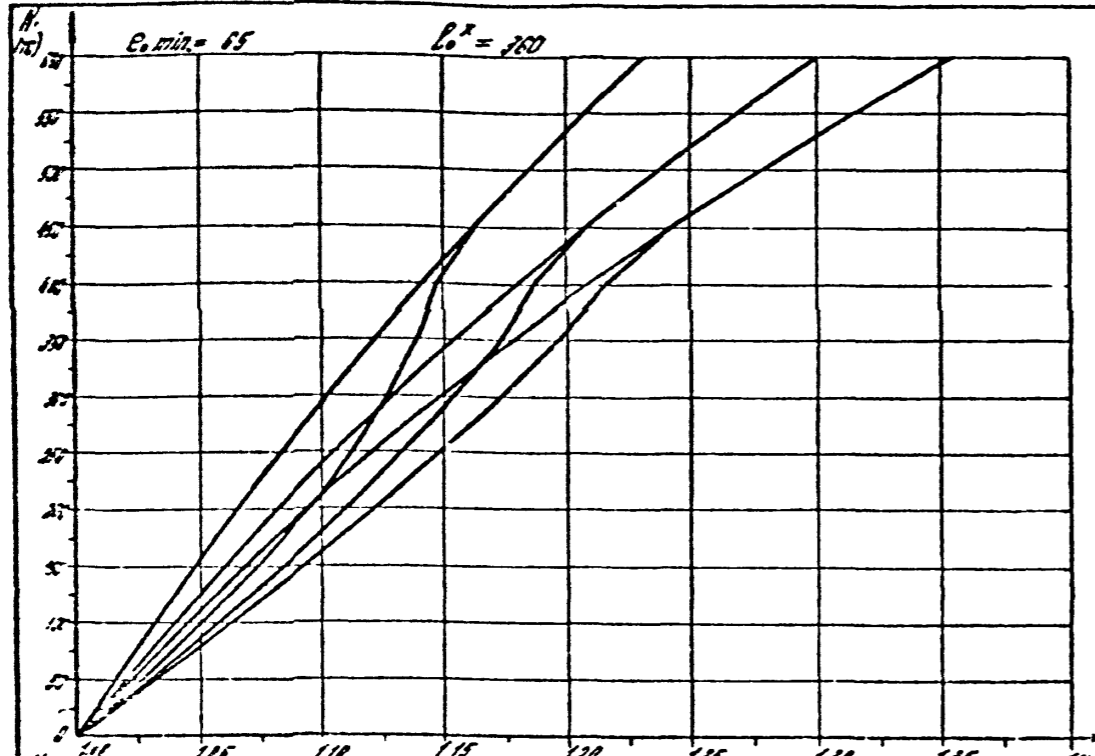

1020-1/87 O-C-3 173

Bx. 32843 1200

193

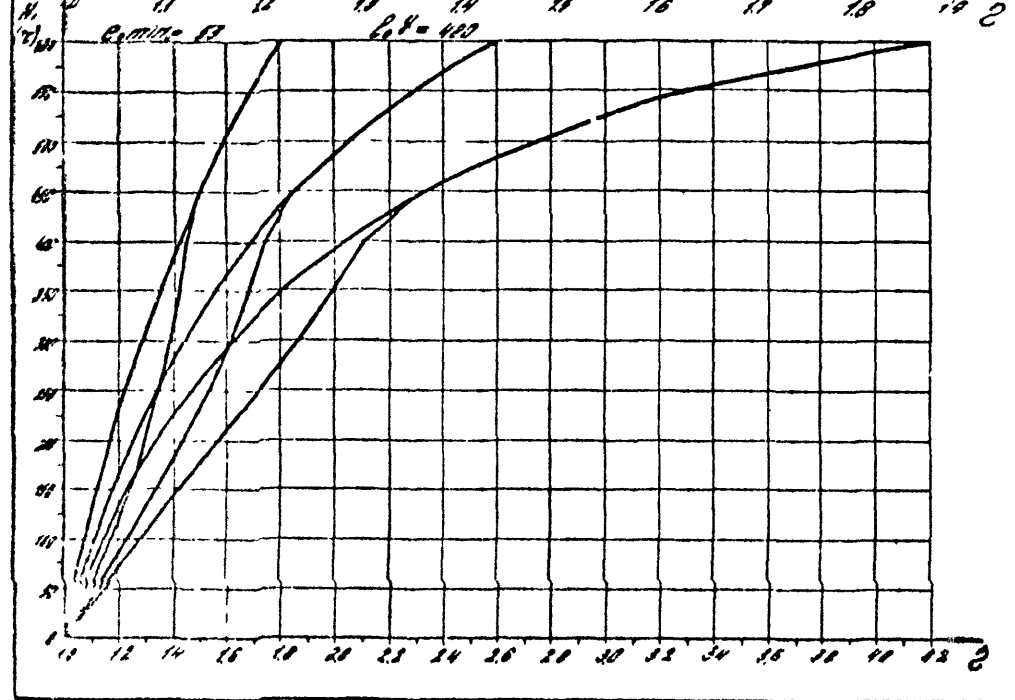
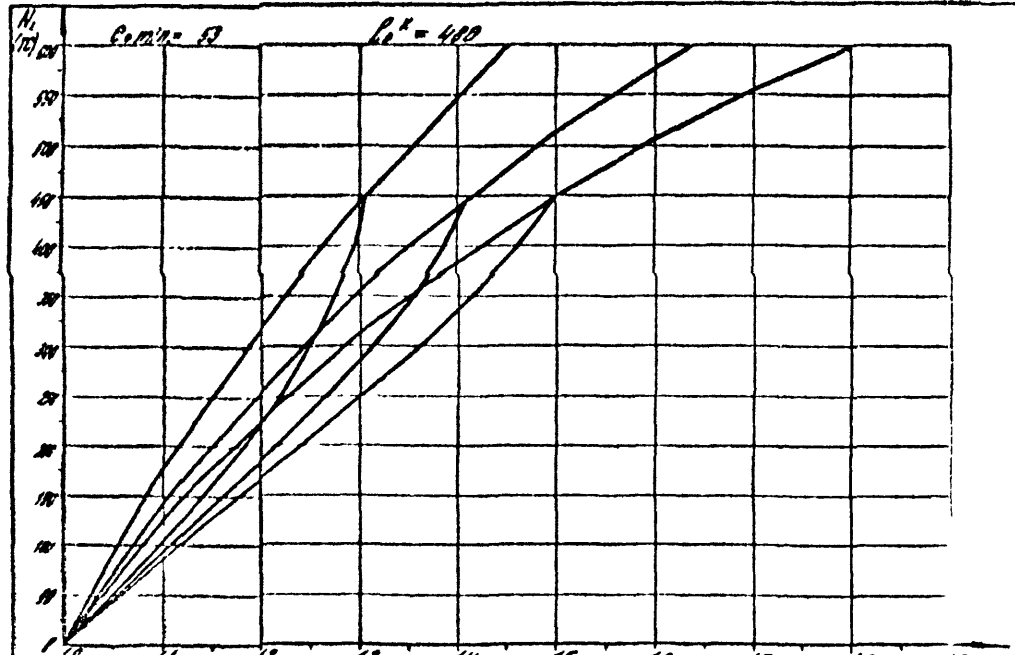

Da. 32824-A. 201

1.020-1/87.0-5-373

194

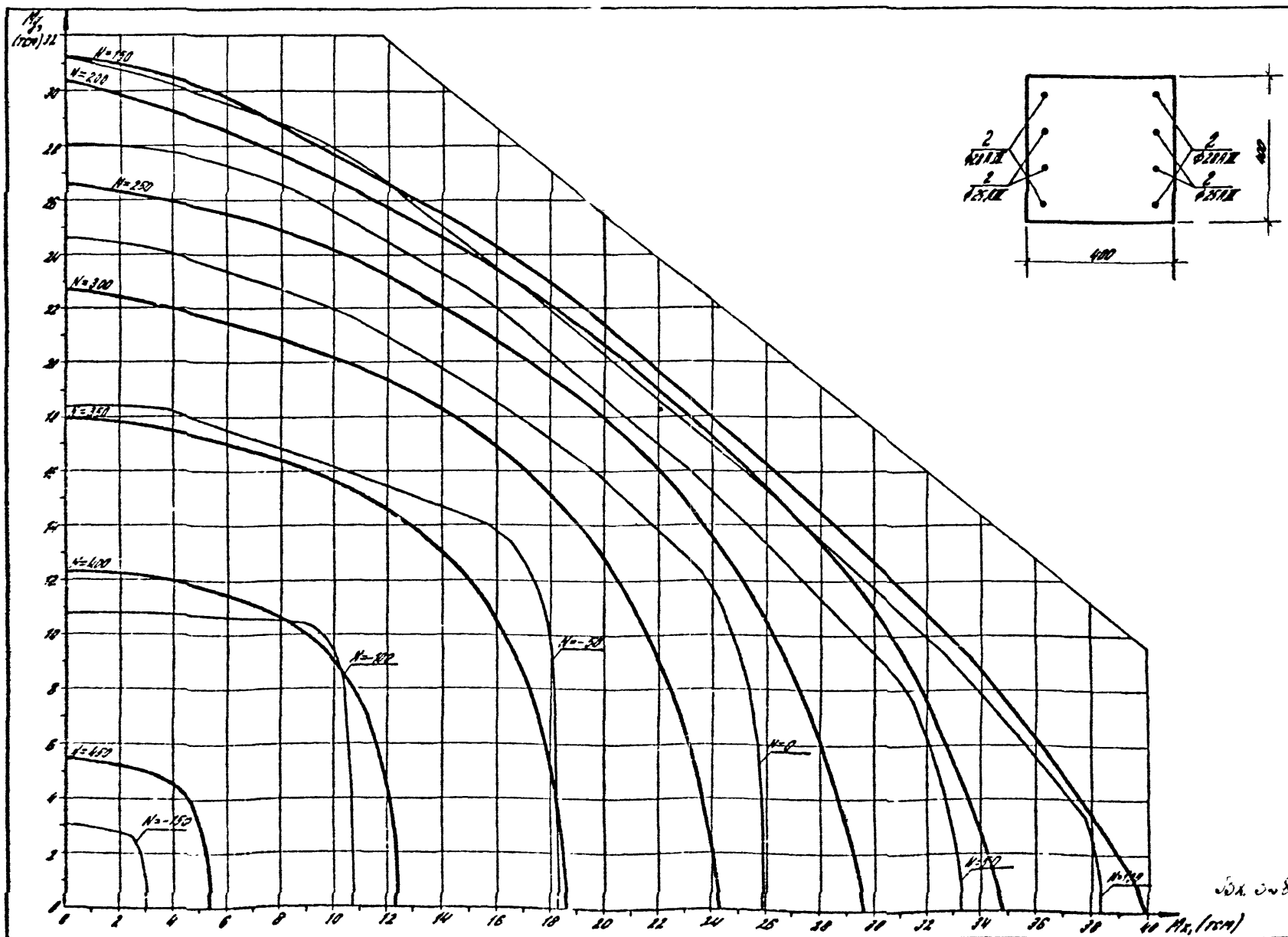

Класс бетона В40 ($R_b = 201.6 \text{ кгс/см}^2$ при учете $\gamma_c = 0.9$)

1020-1/87. 0-6-3 173

Лист 195

С.А. Сидорова